



LP VOLUMETRIC FLOW METER



Operator's Manual



INTRODUCTION

Thank you for choosing USC, LLC for your equipment needs. We appreciate your business and will work diligently to ensure that you are satisfied with your choice.

OVERVIEW

The purpose of this manual is to provide you with the basic information needed to operate and maintain the LP Volumetric Flow Meter. It does not hold USC, LLC liable for any accidents or injuries that may occur.

OPERATOR RESPONSIBILITIES

As the purchaser/owner/operator of this equipment and control system, you have an obligation to install, operate, and maintain the equipment in a manner that minimizes the exposure of people in your care to any potential hazards inherent in using this equipment. It is critical that the owner of this equipment:

- Has a clear and documented understanding of the process this machine is being used in and of any resulting hazards or special requirements arising from this specific application.
- Allow only properly trained and instructed personnel to install, operate, or service this equipment.
- Maintain a comprehensive safety program involving all who work with this machine and other associated process equipment.
- Establish clear areas of staff responsibility (e.g. operation, setup, sanitation, maintenance, and repairs).
- Provide all personnel with necessary safety equipment.
- Periodically inspect the equipment to insure that the doors, covers, guards, and safety devices are in place and functioning, that all safety instructions and warning labels are intact and legible, and that the equipment is in good working order.
- In addition to the operating instructions, observe and enforce the applicable legal and other binding regulations, national and local codes.

As the person with the most to gain or lose from working safely, it is important that you work responsibly and stay alert. By following a few simple rules, you can prevent an accident that could injure or kill you or a co-worker.

LP VOLUMETRIC FLOW METER

- Do not operate, clean, or service this equipment until you have read and understood the contents of this manual. If you do not understand the information in this manual, bring it to the attention of your supervisor, or call your local USC dealer for assistance.
- Any operator who is known or suspected to be under the influence of alcohol or drugs should not be allowed to operate the equipment.
- Understand and follow the safety practices required by your employer and this manual.
- **PAY ATTENTION** to what you and other personnel are doing and how these activities may affect your safety.
- **Failure to follow these instructions may result in serious personal injury or death.**

RECEIVING YOUR EQUIPMENT

As soon as the equipment is received, it should be carefully inspected to make certain that it has sustained no damage during shipment and that all items listed on the packing list are accounted for. If there is any damage or shortages, the purchaser must immediately notify your USC dealer. Ownership passes to purchaser when the unit leaves the USC, LLC. premises. The purchaser is responsible for unloading and mounting all components of the equipment.

TABLE OF CONTENTS

<u>Section</u>	<u>Contents</u>	<u>Page #</u>
Section A	Safety Instructions	5
Section B	Installation	11
	Installing on Stationary or Portable Treater	11
	Installing on Tower System	14
	Wiring Instructions.....	16
Section C	Operating Instructions.....	18
Section D	Calibration	19
	Pump Calibration with Flow Meter.....	19
	Flow Meter Calibration	20
	Using the Flow Meter Calibration Sheet.....	22
Section E	Troubleshooting.....	24
Section F	Maintenance & Storage.....	25
Section G	Mechanical Drawings.....	26
Section H	Limited Warranty.....	29

SAFETY INSTRUCTIONS

SECTION A

Every year accidents in the work place maim, kill, and injure people. Although it may be impossible to prevent all accidents, with the right combination of training, operating practices, safety devices, and operator vigilance, the number of accidents can be significantly reduced. The purpose of this section is to educate equipment users about hazards, unsafe practices, and recommended hazard avoidance techniques.

SAFETY WORDS AND SYMBOLS

It is very important that operators and maintenance personnel understand the words and symbols that are used to communicate safety information. Safety words, their meaning and format, have been standardized for U.S. manufacturers and published by the American National Standards Institute (ANSI). The European Community (E.C.) has adopted a different format based on the International Standards Organization (I.S.O.) and applicable machinery directives. Both formats are presented below. Graphic symbols are not standardized, but most manufacturers will use some variation of the ones seen in this manual.



Indicates an imminently hazardous situation which, if not avoided, **will** result in death or serious injury.



Indicates a potentially hazardous situation which, if not avoided, **could** result in death or serious injury.



Indicates a potentially hazardous situation which, if not avoided, **may** result in minor or moderate injury and/or property damage.



Provides additional information that the operator needs to be aware of to avoid a potentially hazardous situation.



Mandatory Lockout Power Symbol. Disconnect, lockout, and tagout electrical and other energy sources before inspecting, cleaning, or performing maintenance on this panel.



International Safety Alert Symbol. The exclamation point (!) surrounded by a yellow triangle indicates that an injury hazard exists. However, it does not indicate the seriousness of potential injury. The exclamation point (!) is also used with the DANGER, WARNING, and CAUTION symbols so the potential injury is indicated.



Electrocution Hazard Symbol. This symbol indicates that an electrocution hazard exists. Serious injury or death could result from contacting high voltage.



International Electrocution Hazard. This symbol indicates that an electrocution hazard exists. Serious injury or death could result from contacting high voltage.



Mandatory Read Manual Action Symbol. (I.S.O. format) This symbol instructs personnel to read the Operators Manual before servicing or operating the equipment.



Mandatory Read Manual Action Symbol. This symbol instructs personnel to read the Operators Manual before servicing or operating the equipment.

NOTICE

Notice is used to notify people of important installation, operation, or maintenance information which is not hazard related.

LOCKOUT / TAGOUT PROCEDURES

Lockout/Tagout is the placement of a lock/tag on an energy isolating device in accordance with an established procedure. When taking equipment out of service to perform maintenance or repair work, always follow the lockout/tagout procedures as outlined in ANSI Z344.1 and/or OSHA Standard 1910.147. This standard “requires employers to establish a program and utilize procedures for affixing appropriate lockout devices or tagout devices to energy isolating devices and to otherwise disable machines or equipment to prevent unexpected energizing, start-up, or release of stored energy in order to prevent injury to employees.”

HAZARD REVIEW



Electrocution Hazard



Electrocution accidents are most likely to occur during maintenance of the electrical system or when working on or near exposed high voltage wiring. This hazard does not exist when the electrical power has been disconnected, properly locked, and tagged out.



Automatic Start Hazard

This seed treating system is usually controlled by an automated system and may start without warning. Failure to properly disconnect, lockout, and tagout all energy sources of remotely controlled equipment creates a very hazardous situation and could cause injury or even death. PLEASE STAY CLEAR AND BE ALERT.



YOU are responsible for the **SAFE** operation and maintenance of your USC, LLC Seed Treating System. **YOU** must ensure that you and anyone else who is going to operate, maintain, or work around the Seed Treating System be familiar with the operating and maintenance procedures and related **SAFETY** information contained in this manual. This manual will take you step-by-step through your working day and alert you to good safety practices that should be adhered to while operating the Seed Treating System.

Remember, **YOU** are the key to safety. Good safety practices not only protect you, but also the people around you. Make these practices a working part of your safety program. Be certain that **EVERYONE** operating this equipment is familiar with the recommended operating and maintenance procedures and follows all the safety precautions. Most accidents can be prevented. Do not risk injury or death by ignoring good safety practices.

LP VOLUMETRIC FLOW METER

- Flow Meter owners must give operating instructions to operators or employees before allowing them to operate the machine, and at least annually thereafter per OSHA (Occupational Safety and Health Administration) regulation 1928.57.
- The most important safety device on this equipment is a **SAFE** operator. It is the operator's responsibility to read and understand **ALL** Safety and Operating instructions in the manual and to follow them. All accidents can be avoided.
- A person who has not read and understood all operating and safety instructions is not qualified to operate the machine. An untrained operator exposes himself and bystanders to possible serious injury or death.
- Do not modify the equipment in any way. Unauthorized modification may impair the function and/or safety and could affect the life of the equipment.
- Think SAFETY! Work SAFELY!

GENERAL SAFETY

1. Read and understand the Operator's Manual and all safety signs before operating, maintaining, adjusting or unplugging the Flow Meter.
2. Only trained persons shall operate the flow meter. An untrained operator is not qualified to operate the machine.
3. Have a first-aid kit available for use should the need arise, and know how to use it.
4. Provide a fire extinguisher for use in case of an accident. Store in a highly visible place.
5. Do not allow children, spectators or bystanders within hazard area of machine.
6. Wear appropriate protective gear. This includes but is not limited to:
 - A hard hat
 - Protective shoes with slip resistant soles
 - Protective goggles
 - Heavy gloves
 - Hearing protection
 - Respirator or filter mask
7. Place all controls in neutral or off, stop motor, and wait for all moving parts to stop. Then disable power source before servicing, adjusting, repairing, or unplugging.
8. Review safety related items annually with all personnel who will be operating or maintaining the Flow Meter.



OPERATING SAFETY:

1. Read and understand the Operator's Manual and all safety signs before using.
2. Disconnect and disable electrical supply completely and wait for all moving parts to stop before servicing, adjusting, repairing or unplugging.
3. Clear the area of bystanders, especially children, before starting.
4. Be familiar with the machine hazard area. If anyone enters hazard area, shut down machine immediately. Clear the area before restarting.
5. Keep hands, feet, hair and clothing away from all moving and/or rotating parts.
6. Do not operate machine when any guards are removed.
7. Inspect welds and repair if needed.

MAINTENANCE SAFETY

1. Review the Operator's Manual and all safety items before working with, maintaining or operating the Flow Meter.
2. Place all controls in neutral or off, stop motors, disable power source, and wait for all moving parts to stop before servicing, adjusting, repairing or unplugging.
3. Follow good shop practices:
 - Keep service area clean and dry.
 - Be sure electrical outlets and tools are properly grounded.
 - Use adequate light for the job at hand.
4. Keep hands, feet, hair and clothing away from all moving and/or rotating parts.
5. Clear the area of bystanders, especially children, when carrying out any maintenance and repairs or making any adjustments.
6. Before resuming work, install and secure all guards when maintenance work is completed.
7. Keep safety signs clean. Replace any sign that is damaged or not clearly visible.



SAFETY SIGNS

1. Keep safety signs clean and legible at all times.
2. Replace safety signs that are missing or have become illegible.
3. Replaced parts that displayed a safety sign should also display the current sign.
4. Safety signs are available from your Authorized Dealer.

How to Install Safety Signs:

- Be sure that the installation area is clean and dry.
- Be sure temperature is above 50°F (10°C).
- Decide on the exact position before you remove the backing paper.
- Remove the smallest portion of the split backing paper.
- Align the sign over the specified area and carefully press the small portion with the exposed sticky backing in place.
- Slowly peel back the remaining paper and carefully smooth the remaining portion of the sign in place.
- Small air pockets can be pierced with a pin and smoothed out using the piece of sign backing paper.

INSTALLATION

SECTION B

MOUNTING FLOW METER

USC, LLC recommends mounting the flow meter on the right-hand side of the seed treater. The flow meter display should be facing toward the front of the seed treater so it can be read while standing in front of the main control panel.

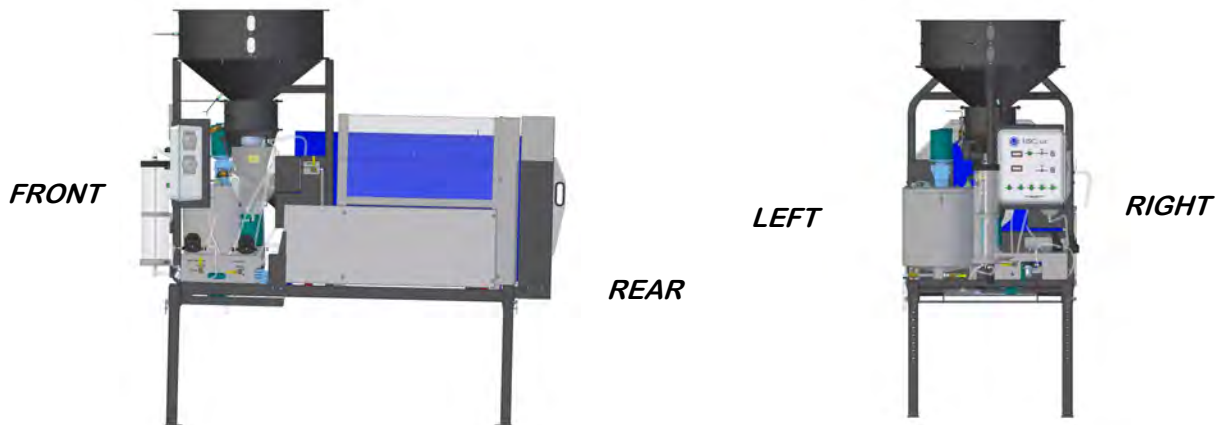

MOUNTING FLOW METER TO STATIONARY OR PORTABLE LP-SERIES SEED TREATER

1. Remove the back chain guard bolt (if applicable) and mount the flow meter bracket with one of the mounting holes. Leave the bolt hand tight. If the bolt does not exist, drill a 5/16" hole and tap to 3/8".
2. Line up the other mounting hole on the frame of the treater. Drill a 5/16" hole and tap to 3/8". Using the 3/8" bolt provided, tighten the flow meter bracket to the frame of the seed treater. The two mounting holes are approximately 12.5" apart.

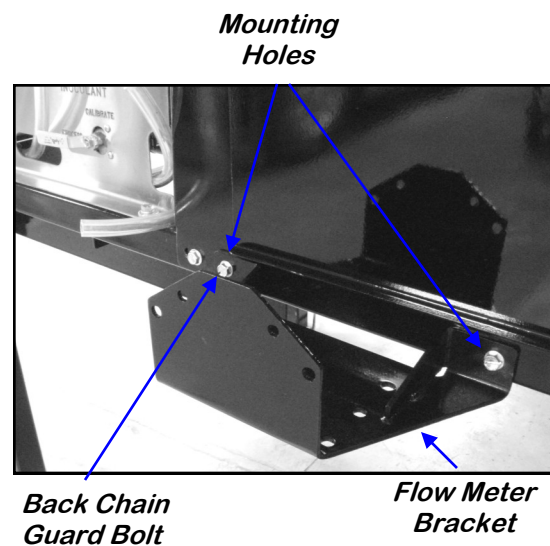

LP VOLUMETRIC FLOW METER

- Using the 3/8" x 2.5" bolt, the 3/8" lock nuts, and the flow meter clamp, mount the flow meter to the bracket with the display of the flow meter facing forward (below).



- Check the flow meter flow direction. The flow is represented by an arrow on the flow meter label (below) and on the bottom side of the flow meter.

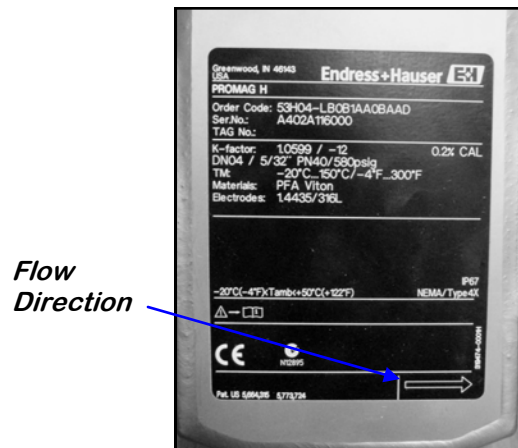

- Unclamp the Pump #1 pump tubing from the hose connecting to the SEED TREATMENT valve.

LP VOLUMETRIC FLOW METER

5. Connect a piece of tubing from the Pump #1 pump tubing to the flow meter inlet. (Figure A) Leave enough of the clear tubing to allow the pump tubing to be fully used.
6. Connect a piece of tubing from the SEED TREATMENT valve to the flow meter outlet. (Figure B)

NOTICE Cut off any excess tubing. This will allow for easier clean-up and better accuracy.

7. Hook the flow meter cord to the receptacle. The receptacle will need to be mounted into the seed treater control panel. Refer to page 16 for wiring instructions.
8. Turn power on to the flow meter. The meter will go through several start-up parameters before advancing to the main flow display screen.

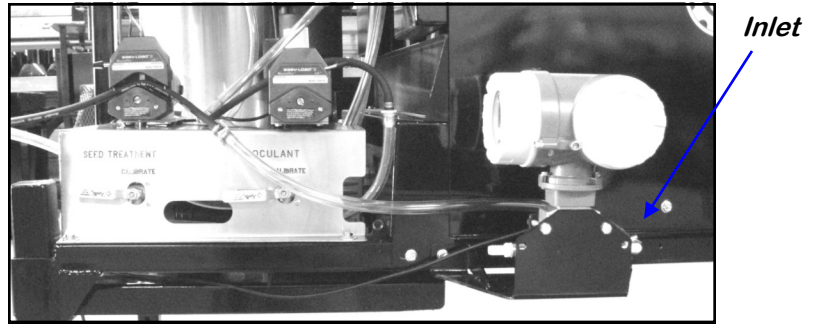

Figure A

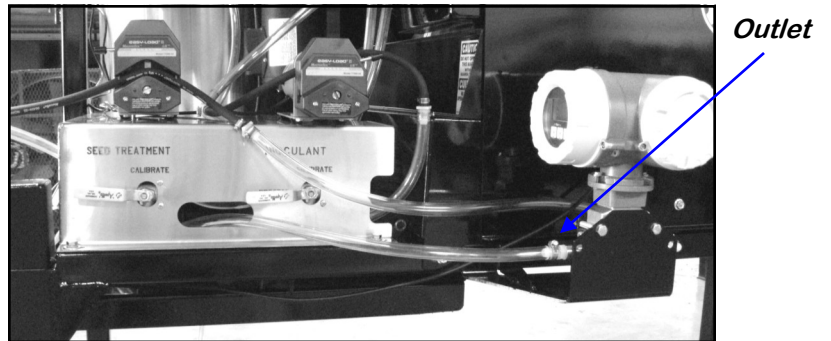
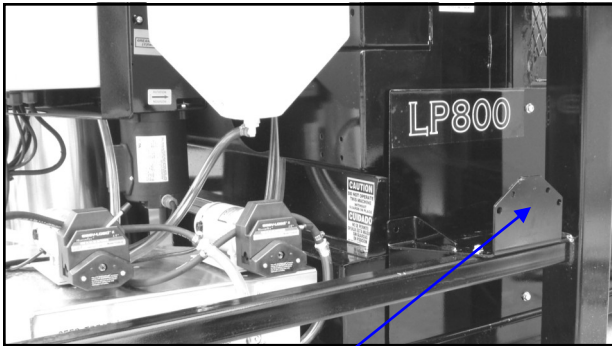

Figure B

MOUNTING FLOW METER TO TOWER SEED TREATER

1. Line the mounting holes on the seed treater tower support bar. Drill two 5/16” holes in the support bar and tap to 3/8”. Using the 3/8” bolts provided, tighten the flow meter bracket to the tower support bar. The mounting holes are approximately 6.5” apart.



Flow Meter Bracket

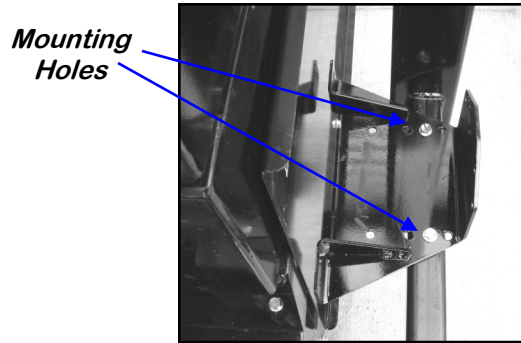

Top View of Flow Meter Bracket on Tower Support Bar

2. Using the 3/8” x 2.5” bolt, the 3/8” lock nuts, and the flow meter clamp, mount the flow meter to the bracket with the display of the flow meter facing forward (below).



3. Check the flow meter flow direction. The flow is represented by an arrow on the flow meter label (right) and on the bottom side of the flow meter.
4. Unclamp the Pump #1 pump tubing from the hose connecting to the SEED TREATMENT valve.

Flow Direction

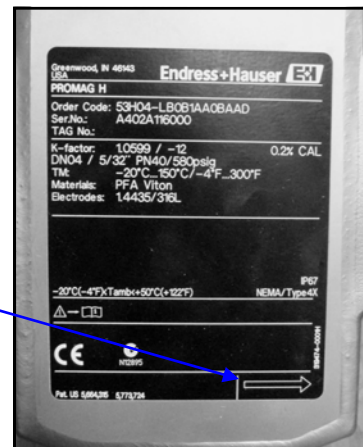

LP VOLUMETRIC FLOW METER

5. Connect a piece of tubing from the Pump #1 pump tubing to the flow meter inlet. (Figure A) Leave enough of the clear tubing to allow the pump tubing to be fully used.
6. Connect a piece of tubing from the SEED TREATMENT valve to the flow meter outlet. (Figure B)

NOTICE Cut off any excess tubing. This will allow for easier clean-up and better accuracy.

7. Hook the flow meter cord to the receptacle. The receptacle will need to be mounted into the seed treater control panel. Refer to page 16 for wiring instructions.
8. Turn power on to the flow meter. The meter will go through several start-up parameters before advancing to the main flow display

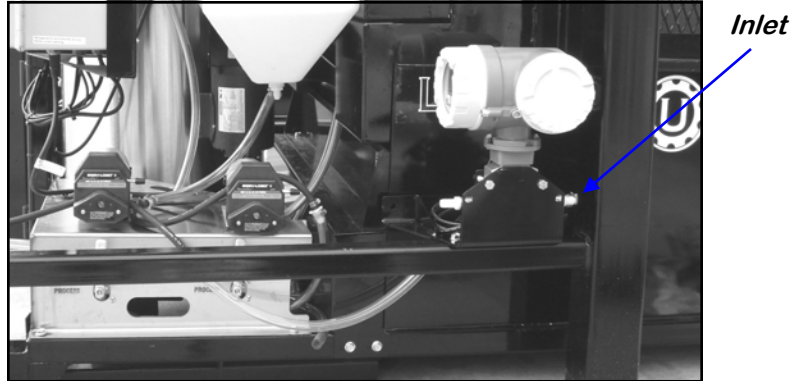

Figure A

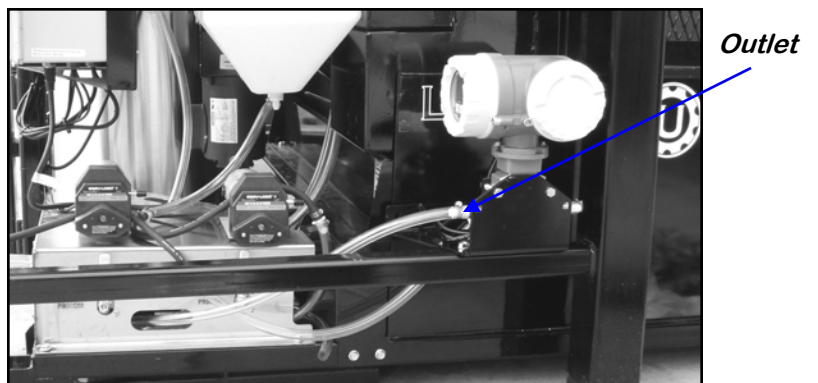

Figure B

ELECTRICAL INSTALLATION



HIGH VOLTAGE ~ always disconnect the power source before working on or near the control panel or lead wires.



HIGH VOLTAGE ~ Use insulated tools when making adjustments while the controls are under power.

The following steps illustrate how to install the flow meter receptacle in the seed treater control panel.

NOTICE

Some newer model seed treaters already include the flow meter receptacle. Skip the electrical installation section if this receptacle is including in the seed treater control panel.

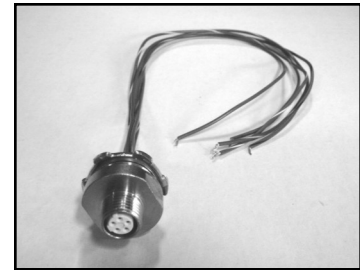

Flow Meter receptacle

1. Drill a 7/8" hole in the bottom of the seed treater main control panel.



Make certain that all wires located on the inside of the control panel are clear before drilling.

2. Install the flow meter receptacle so the wires are on the inside of the control panel.
3. Connect the 3 wires from the receptacle. Refer to the opposite page for wiring instructions.

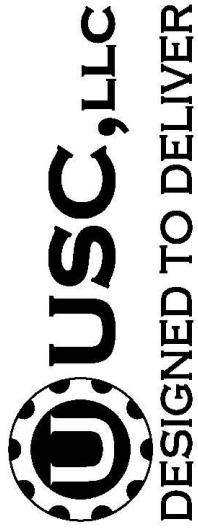

2320 124th Rd
 Sabetha, KS 66534-9459 USA
 Phone: (785) 284-0048
 Fax: (785) 284-0032

E+H FLOW METER ELECTRICAL INSTALLATION

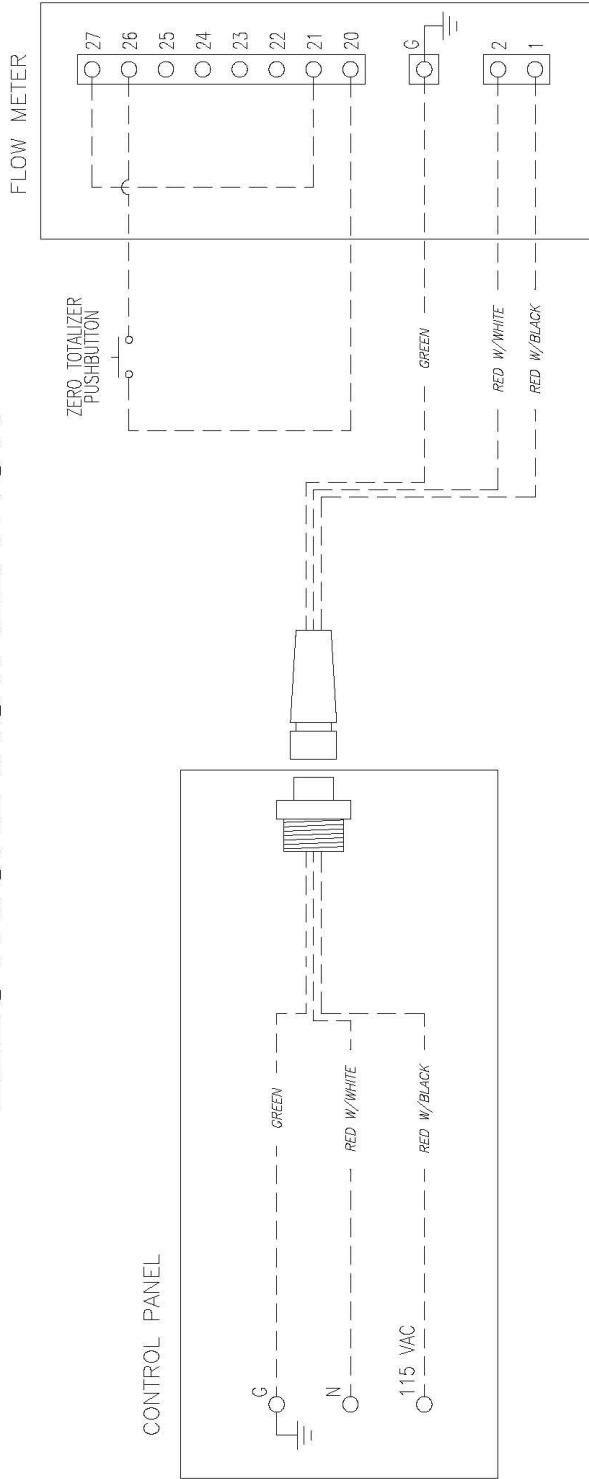

THIS DRAWING AND THE DESIGN FEATURES DISCLOSED ARE THE PROPRIETARY PROPERTY OF USC, LLC AND ARE NOT TO BE REPRODUCED OR USED IN ANY MANNER DETRIMENTAL TO USC, LLC'S INTEREST AND SHALL BE RETURNED UPON REQUEST.

USC FILE NO.	DATE	REV.
13-04-0063 SH 1	10/20/08	E+H FLOW METER ELECTRICAL INSTALLATION
DESIGNED BY: L. STRAHM		DRAWING NO. 13-04-0063
SHEET 1 OF 1		REV. B

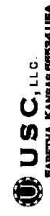

**SECTION
C**

OPERATING INSTRUCTIONS

The volumetric flow meter is programmed at USC to display ounces per minute and total ounces. Metric units can also be displayed if specified during ordering. The front part of the flow meter display is a touch screen. If you need to clean the screen, be sure to disconnect power to the flow meter before cleaning. This will avoid accidentally changing any parameters.

Ounces per Minute (ozf/min) and Total Ounces (ozf) are both displayed on the same screen of the volumetric flow meter. To “Zero” out the total ounces used, you simply push the “ZERO FLOW METER TOTALIZER” button located on the left side of the flow meter.

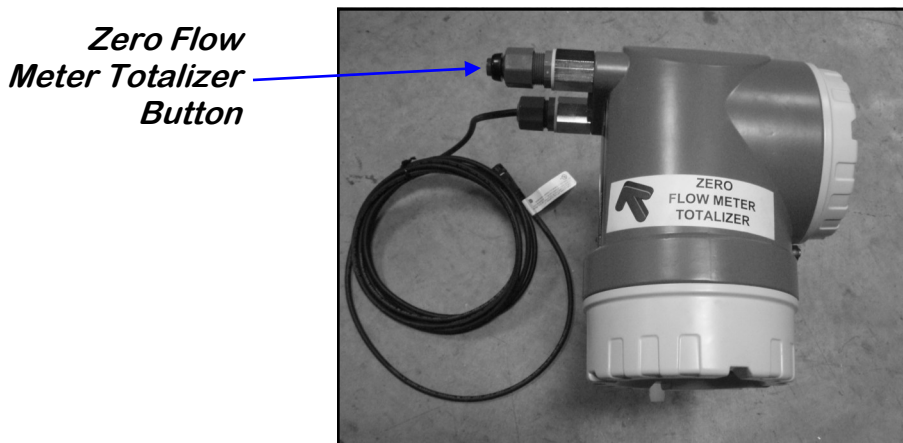
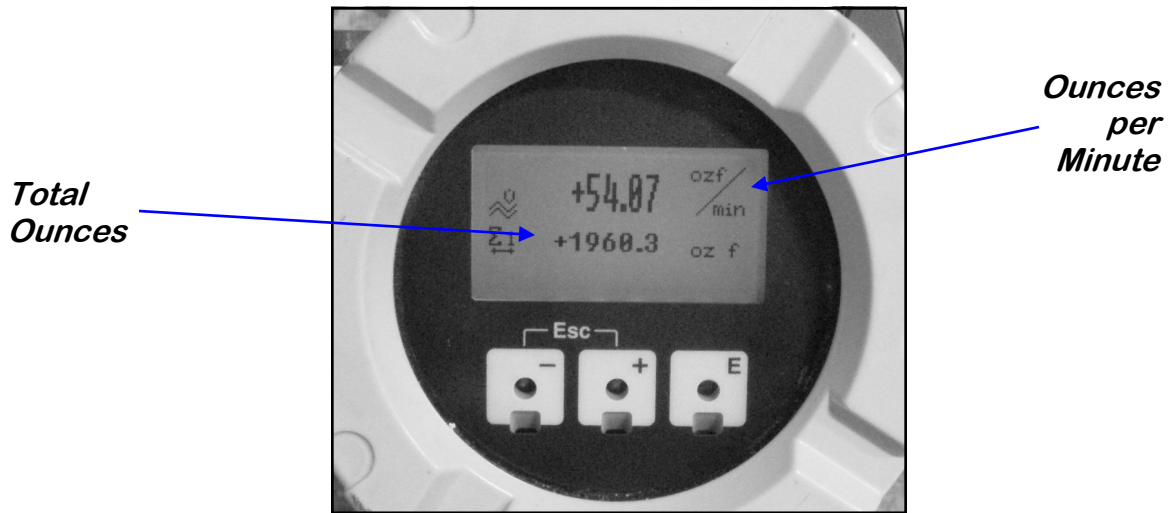

CALIBRATION

SECTION D

PUMP CALIBRATION WITH FLOW METER

The following steps illustrate how to calibrate a pump with a flow meter on an LP series seed treater.

1. Lock down the pump tubing in the pump head.
2. Premix enough liquid for the amount of seed you are treating and pour into the 27 gallon stainless steel tank. It's always a good practice to mix up 20% extra slurry to help fill all the lines. Turn on the mix tank and allow liquid to mix.
3. Turn the "SEED TREATMENT SOURCE" valve to the "MIX TANK" position, the "SEED TREATMENT" valve to the "CALIBRATE" position and, the valve on top of the mix tank to "MIX TANK".
4. Place the pump direction switch to "FORWARD".
5. Turn the "Hand/Off/Auto" switch to the "Hand" position and set the Pump #1 liquid adjust dial (right) to about "500" or half speed. The liquid should begin re-circulating from the bottom of the mix tank, through the pump, and back into the top of the mix tank.
6. Allow pump to re-circulate liquid for approximately 15 minutes to ensure all air has been removed from the liquid lines. This will also help "break-in" the pump tubing, which is critical before checking pump calibration.
7. After you have allowed the liquid to re-circulate you are ready to calibrate the liquid flow. Determine the number of ounces needed in one minute.



EXAMPLE: The seed treatment slurry rate is 5 ounces per cwt.
 Seed Flow Rate = 10.8 cwt/min. x 5 oz./cwt. = 54 oz./min.
 54 oz. is the rate the pump should be pumping in one minute.

8. Set the Liquid Flow Rate. Using the Liquid Adj. dial. Increase or decrease the pump speed until the liquid flow rate has been matched.
9. Once the flow rate is set you can begin the seed treating process. The flow rate can still be adjusted during the treating process.

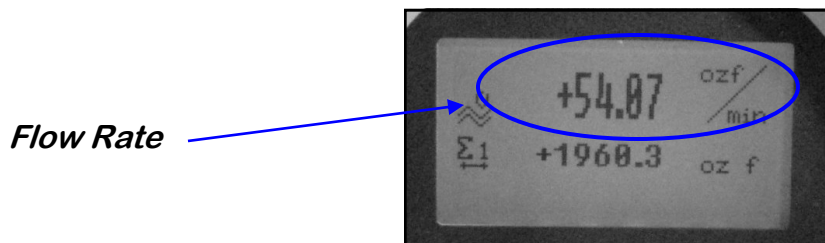

FLOW METER CALIBRATION

The following steps illustrate how to calibrate a flow meter on an LP series seed treater. You will need a stopwatch for this calibration

1. Determine a desired flow rate

EXAMPLE: The seed treatment slurry rate is 5 ounces per cwt.
Seed Flow Rate = 10.8 cwt/min. x 5 oz./cwt. = 54 oz./min.
54 oz. is the rate the pump should be pumping in one minute.

2. Set the Liquid Flow Rate. Using the Liquid Adj. dial. Increase or decrease the pump speed until the liquid flow rate has been matched.
3. Begin the calibration process by pumping chemical into the calibration tube and using the stop watch to start timing once the liquid reaches the zero mark on the calibration tube.
4. Note the rate that the flow meter is currently reading

EXAMPLE: Flow meter reading = 54 Oz./min

5. After approximately one minute, simultaneously stop timing and shut down the flow of liquid to the calibration tube.
6. Note the total ounces of liquid in the calibration tube and the total amount of time that it took to fill the tube to that level in seconds. Divide those two numbers to find the ounces per second (Oz./Sec) of liquid application rate. Now multiply the ounces per second of liquid application rate by 60 to get the ounces per minute (Oz./Min) liquid application rate. This number is the actual amount of ounces per minute that the pump is currently pumping.

EXAMPLE: Total ounces of liquid in the calibration tube = 57 ounces.
Total amount of time to fill calibration tube = 62 seconds.
Oz./Sec liquid application rate = 57 ounces / 62 seconds = 0.9194
Oz./Min liquid application rate = 0.9194 x 60 seconds = 55.16
The actual liquid application rate is 55.16 Oz./min

LP VOLUMETRIC FLOW METER

7. Take the flow meter reading that was previously noted and divide it by the actual liquid application rate. This number will give you the calibration factor that the flow meter reading will need to be adjusted by.

EXAMPLE: Flow meter reading = 54 Oz./min
Actual liquid application rate = 55.16 Oz./min
Calibration factor = $54 / 55.16 = 0.9790$

The calibration factor is 0.9790

8. In order to find the flow meter reading that is needed for accurate application of the liquid, you must now multiply the calibration factor by the desired application rate.

EXAMPLE: Calibration factor = 0.9790
Desired flow rate = 54 Oz./min
Flow meter reading for accurate application = $0.9790 \times 54 = 52.87$

52.87 Oz./min is the rate that the flow meter should read to ensure proper flow is being achieved.

9. Now you can set the pump dial so that the flow meter will read the rate that is needed to ensure the accurate flow of liquid s being applied to the seed.

USING THE FLOW METER CALIBRATION WORKSHEET

The following steps illustrate how to use the flow meter calibration worksheet found on the CD in the back of this manual. This worksheet will simplify the calibration of the flow meter. The worksheet uses Excel format and is named: "Flow Meter Calibration Sheet." Below is an screen shoot of the actual worksheet. You will need a stop watch to complete this calibration.

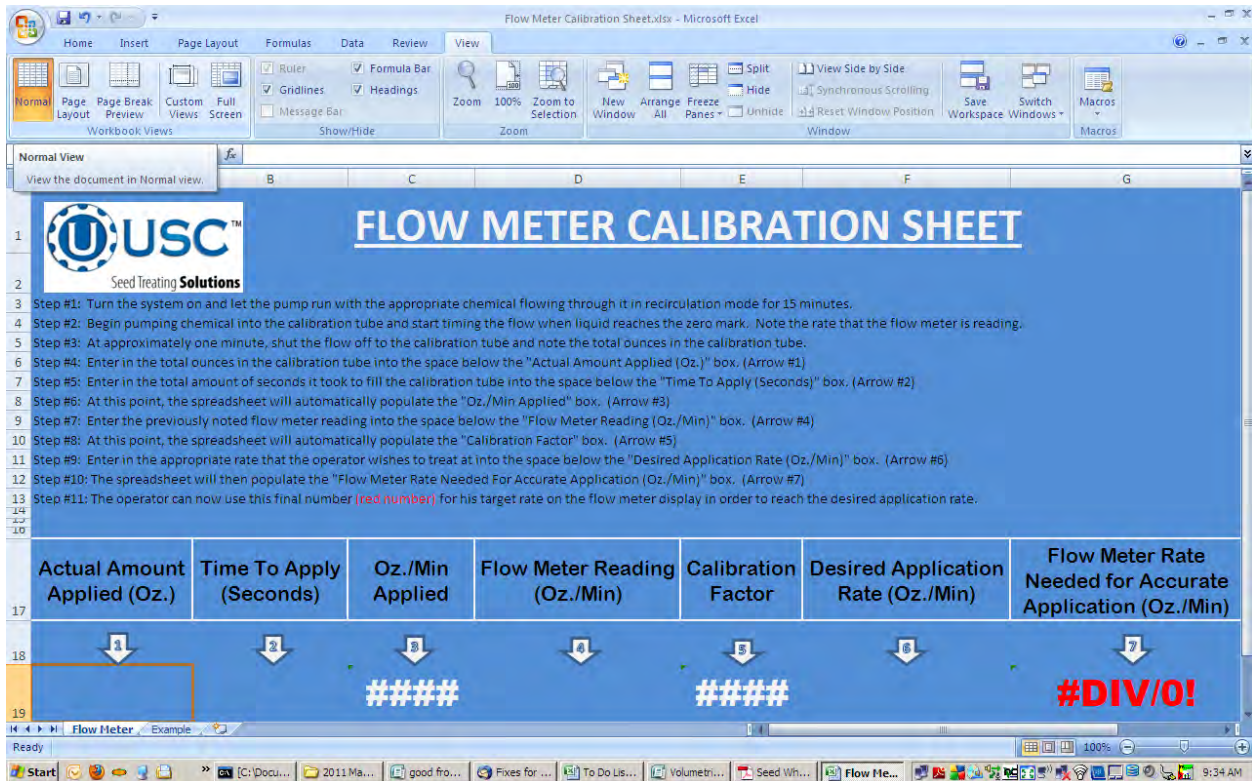

1. Allow pump to re-circulate liquid for approximately 15 minutes to ensure all air has been removed from the liquid lines. This will also help "break-in" the pump tubing, which is critical before checking flow meter calibration.
2. Begin pumping chemical into the calibration tube and start timing the flow when liquid reaches the zero mark. Note the rate that the flow meter is reading.
3. At approximately one minute, shut the flow off to the calibration tube and note the total ounces in the calibration tube.
4. Enter in the total ounces in the calibration tube into the space below the "Actual Amount Applied (Oz.)" box. (Arrow #1) **EXAMPLE: 35**

Actual Amount Applied (Oz.)	Time To Apply (Seconds)	Oz./Min Applied	Flow Meter Reading (Oz./Min)	Calibration Factor	Desired Application Rate (Oz./Min)	Flow Meter Rate Needed for Accurate Application (Oz./Min)
35		#####	#####			#VALUE!

LP VOLUMETRIC FLOW METER

5. Enter in the total amount of seconds it took to fill the calibration tube into the space below the "Time To Apply (Seconds)" box. (Arrow #2) **EXAMPLE: 65**
6. At this point, the spreadsheet will automatically populate the "Oz./Min Applied" box. (Arrow #3) **EXAMPLE: 32.3**

Actual Amount Applied (Oz.)	Time To Apply (Seconds)	Oz./Min Applied	Flow Meter Reading (Oz./Min)	Calibration Factor	Desired Application Rate (Oz./Min)	Flow Meter Rate Needed for Accurate Application (Oz./Min)
35	65	32.3		0		0

7. Enter the previously noted flow meter reading into the space below the "Flow Meter Reading (Oz./Min)" box. (Arrow #4) **EXAMPLE: 30**
8. At this point, the spreadsheet will automatically populate the "Calibration Factor" box. (Arrow #5) **EXAMPLE: 0.93**

Actual Amount Applied (Oz.)	Time To Apply (Seconds)	Oz./Min Applied	Flow Meter Reading (Oz./Min)	Calibration Factor	Desired Application Rate (Oz./Min)	Flow Meter Rate Needed for Accurate Application (Oz./Min)
35	65	32.3	30	0.93		0

9. Enter in the appropriate rate that the operator wishes to treat at into the space below the "Desired Application Rate (Oz./Min)" box. (Arrow #6) **EXAMPLE: 30**
10. The spreadsheet will then populate the "Flow Meter Rate Needed For Accurate Application (Oz./Min)" box. (Arrow #7) **EXAMPLE: 27.86**
11. The operator can now use this final number (red number) for his target rate on the flow meter display in order to reach the desired application rate. **EXAMPLE: 27.86**

Actual Amount Applied (Oz.)	Time To Apply (Seconds)	Oz./Min Applied	Flow Meter Reading (Oz./Min)	Calibration Factor	Desired Application Rate (Oz./Min)	Flow Meter Rate Needed for Accurate Application (Oz./Min)
35	65	32.3	30	0.93	30	27.86

**SECTION
E**

TROUBLESHOOTING

Below is a table describing the most frequent problems and solutions with the LP volumetric flow meter. Call your local dealer for additional technical support.

Problem	Possible Cause	Solution
Flow Meter is fluctuating	<ol style="list-style-type: none"> 1. Pump is sucking air. 2. Restriction in the line. 3. Flow meter is not full of liquid 	<ol style="list-style-type: none"> 1. Check and tighten all hose connections. 1. Check filter to see if gasket is missing or cracked. 2. Clean out filter and lines to check for any debris. 3. The meter will fluctuate if there is nothing pumping and there is some liquid left in the meter. Drain out liquid.
Flow meter won't turn on	<ol style="list-style-type: none"> 1. Improper power going to flow meter. 2. Loose connection. 	<ol style="list-style-type: none"> 1. Check incoming power to flow meter. 2. Check connections inside the control panel and inside the flow meter.
Flow Meter is reading too low or too high.	<ol style="list-style-type: none"> 1. Restriction in Flow Meter or in line. 2. Air in treatment. This can cause the flow meter to read lower than calibrating it using a measuring cup. 3. Seed flow has changed. 	<ol style="list-style-type: none"> 1. Flush the flow meter with water or use compressed air and blow air backwards through the meter. 2. Check and tighten all hose connections. 2. Check filter to see if gasket is missing or cracked. 3. Recheck seed flow rate.
Flow meter will not zero	<ol style="list-style-type: none"> 1. Improper wiring 2. Wrong parameter programmed into flow meter 	<ol style="list-style-type: none"> 1. Check wiring schematic (page 17). 2. Check flow meter parameters. Call local dealer.

MAINTENANCE & STORAGE

SECTION F

Proper maintenance and storage of the flow meter is critical for peak performance, reliability and accuracy of this system. The following is a guideline for the type of maintenance and storage procedure that should be followed. Your environment and uses may require additional maintenance and service beyond this list to assure a reliable and safe unit. The operator of this unit has ultimate responsibility to identify areas of concern and rectify them before they become a hazard or safety issue. There is no substitute for a trained, alert operator.

1. Make certain the inside of the tank is completely drained of chemical residue and thoroughly flush the inside of the tank with clean water.
2. Remove and clean the filter if applicable.
3. Pump clean water through all areas of the plumbing including the mix tank, valves, and flow meter.
4. Open all drain points, valves, and filter to let as much of the liquid drain as possible.
5. Disconnect power to the flow meter.
6. Remove the flow meter from the machine and store in an area with the following aspects.
 - Ambient temperature of 50 to 80 degrees Fahrenheit.
 - Protection from direct sunlight to avoid unacceptable high surface temperatures.
 - Where moisture does not collect in and/or on the flow meter. This will help prevent fungus and bacteria infestation which can damage the liner.
 - Cover all openings
 - Store in a manner so that the inlet and outlet are as much in an up and down position as possible (right).

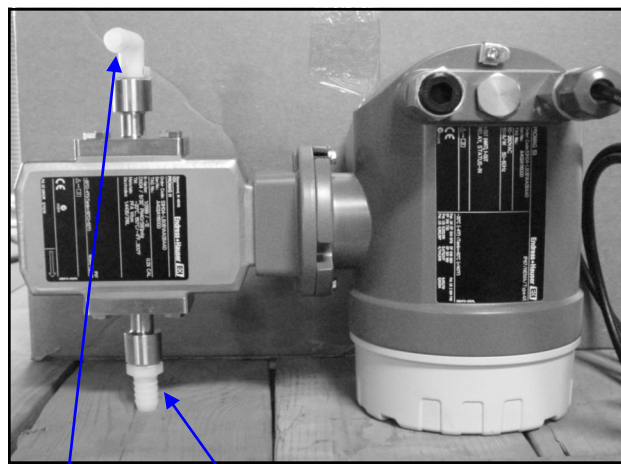

Inlet

Outlet

LP Volumetric Flow Meter

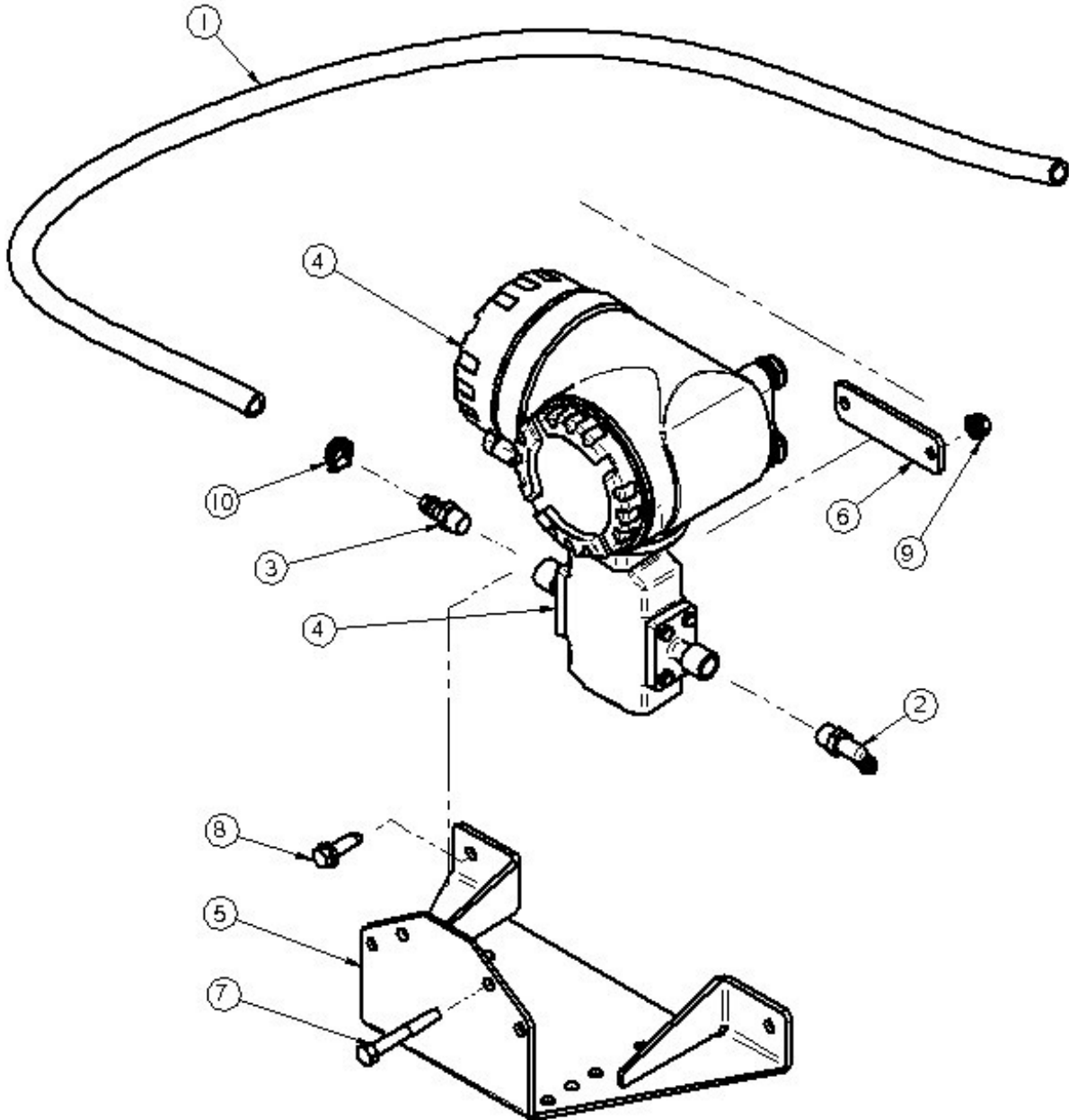

LP VOLUMETRIC FLOW METER

LP Volumetric Flow Meter Parts List

Item #	PART #	Title	Qty
1	02-03-0005	HOSE RNT .500 CLEAR	1
2	02-06-0009	3/8-18 NPT, 1/2 BARB, 90 DEG. WP	1
3	02-08-0006	FTTG STGHT .500HB X .375NPT ML NYL	1
4	03-18-0007	ASSY FLMT PROMAG 53H DN	1
5	05-10-2033	BRKT FLMT MNT PROMAG 53H	1
6	05-10-2038	BRKT FLMT MNT PROMAG 53H	1
7	06-01-0116	BOLT .375-16 X 2.75 ZP GR5	2
8	06-01-0118	SCRW SELF THREADING .375-16 X 1.250	2
9	06-03-0014	NUT,LOCK, FLG .375-16 ZP SERRATTED	2
10	06-07-0006	CLMP HOSE .500 TO .906 X .313W ZP	1

NOTES

A large, empty rectangular box with a black border, intended for handwritten notes.

SECTION
H**LIMITED WARRANTY**

USC, LLC, (Manufacturer) warrants its seed treating equipment as follows:

1. **Limited Warranty:** Manufacturer warrants that the Products sold hereunder will be free from defects in material and workmanship for a period of 12 months from date of shipment. If the Products do not conform to this Limited Warranty during the warranty period, Buyer shall notify Manufacturer in writing of the claimed defects and demonstrate to Manufacturer satisfaction that said defects are covered by this Limited Warranty. If the defects are properly reported to Manufacturer within the warranty period, and the defects are of such type and nature as to be covered by this warranty, Manufacturer shall, at its expense, furnish replacement Products or, at Manufacturer's option, replacement parts for the defective products. Shipping and installation of the replacement Products or replacement parts shall be at the Buyer's expense.

2. **Other Limits:** THE FOREGOING IS IN LIEU OF ALL OTHER WARRANTIES, EXPRESSED OR IMPLIED, INCLUDING BUT NOT LIMITED TO THE IMPLIED WARRANTIES OF MERCHANTABILITY AND FITNESS FOR A PARTICULAR PURPOSE. Manufacturer does not warrant against damages or defects arising from improper installation (where installation is by persons other than Manufacturer), against defects in products or components not manufactured by Manufacturer, or against damages resulting from such non-Manufacturer made products or components. Manufacturer passes on to the Buyer the warranty it received (if any) from the maker of such non-Manufacturer made products or components. This warranty also does not apply to Products upon which repairs and/or modifications have been effected or attempted by persons other than pursuant to written authorization by Manufacturer. Manufacturer does not warrant against casualties or damages resulting from misuse and/or abuse of product(s), acts of nature, effects of weather, including effects of weather due to outside storage, accidents, or damages incurred during transportation by common carrier.

3. **Exclusive Obligation:** THIS WARRANTY IS EXCLUSIVE. The sole and exclusive obligation of Manufacturer shall be to repair or replace the defective Products in the manner and for the period provided above. Manufacturer shall not have any other obligation with respect to the Products or any part thereof, whether based on contract, tort, strict liability or otherwise. Under no circumstances, whether based on this Limited Warranty or otherwise, shall Manufacturer be liable for incidental, special, or consequential damages.

4. **Other Statements:** Manufacturer's employees or representatives' oral or other written statements do not constitute warranties, shall not be relied upon by Buyer, and are not a part of the contract for sale or this limited warranty.

5. **Return Policy:** Approval is required prior to returning goods to USC, LLC. A restocking fee will apply.

6. **Entire Obligation:** This Limited Warranty states the entire obligation of Manufacturer with respect to the Products. If any part of this Limited Warranty is determined to be void or illegal, the remainder shall remain in full force and effect.



USC, LLC

2320 124th road

Sabetha, Ks 66534

PHONE: (785) 431-7900

FAX: (785) 431-7950

EMAIL: sales-team@uscllc.com

WEB: www.uscllc.com