

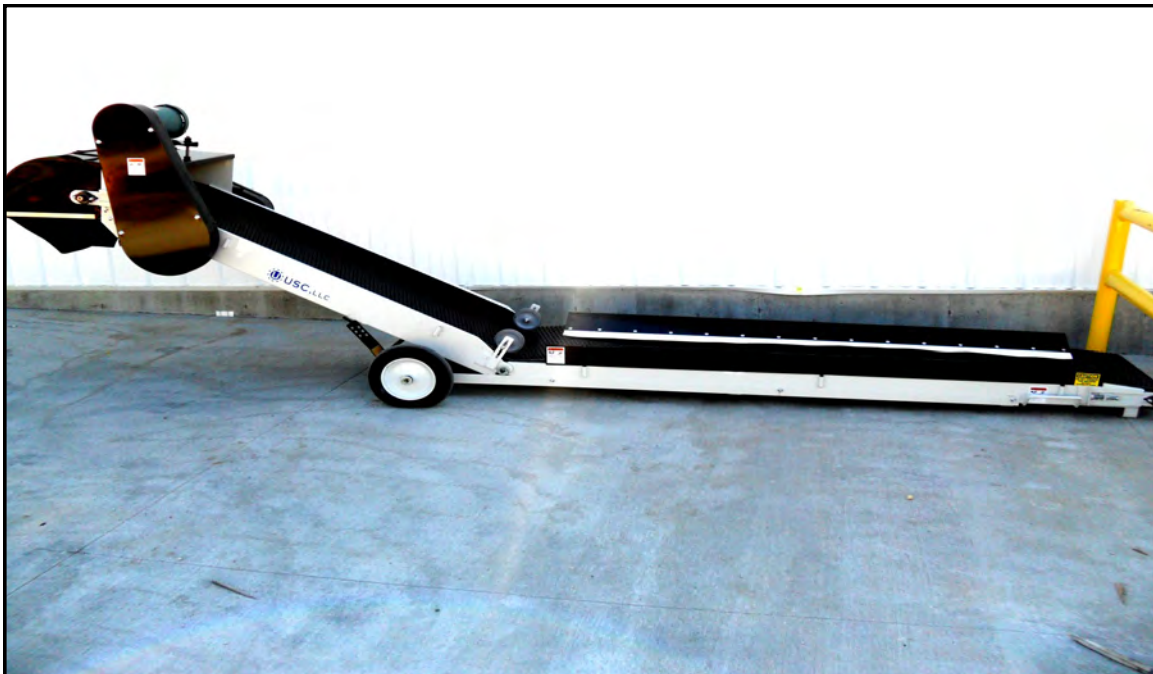

# TRUCK UNLOAD CONVEYOR



## *Operator's Manual*



# **INTRODUCTION**

**Thank you for choosing USC LLC for your equipment needs. We appreciate your business and will work diligently to ensure that you are satisfied with your choice.**

## **OVERVIEW**

The purpose of this manual is to provide you with the basic information needed to operate and maintain the USC Truck Unload Conveyor. It does not hold USC, LLC liable for any incidents or injuries that may occur.

## **OPERATOR RESPONSIBILITIES**

As the purchaser/owner/operator of this equipment and control system, you have an obligation to install, operate, and maintain the equipment in a manner that minimizes the exposure of people in your care to any potential hazards inherent in using this equipment. It is critical that the owner of this equipment:

- Has a clear and documented understanding of the process this machine is being used in and of any resulting hazards or special requirements arising from this specific application.
- Allow only properly trained and instructed personnel to install, operate, or service this equipment.
- Maintain a comprehensive safety program involving all who work with this machine and other associated process equipment.
- Establish clear areas of staff responsibility (e.g. operation, setup, sanitation, maintenance, and repairs).
- Provide all personnel with necessary safety equipment.
- Periodically inspect the equipment to insure that the doors, covers, guards, and safety devices are in place and functioning, that all safety instructions and warning labels are intact and legible, and that the equipment is in good working order.
- In addition to the operating instructions, observe and enforce the applicable legal and other binding regulations, national and local codes.

As the person with the most to gain or lose from working safely, it is important that you work responsibly and stay alert. By following a few simple rules, you can prevent an accident that could injure or kill you or a co-worker.

- Disconnect, lockout, and tagout electrical and all other energy sources before inspecting, cleaning, servicing, repairing, or any other activity that would expose you to the hazards of electrical shock.

## TRUCK UNLOAD CONVEYOR

- Do not operate, clean, or service this equipment until you have read and understood the contents of this manual. If you do not understand the information in this manual, bring it to the attention of your supervisor, or call your local USC dealer for assistance.
- Any operator who is known or suspected to be under the influence of alcohol or drugs should not be allowed to operate the equipment.
- Understand and follow the safety practices required by your employer and this manual.
- **PAY ATTENTION** to what you and other personnel are doing and how these activities may affect your safety.
- **Failure to follow these instructions may result in serious personal injury or death.**

### RECEIVING YOUR EQUIPMENT

As soon as the equipment is received, it should be carefully inspected to make certain that it has sustained no damage during shipment and that all items listed on the packing list are accounted for. If there is any damage or shortages, the purchaser must immediately notify your USC dealer. Ownership passes to purchaser when the unit leaves the USC, LLC. premises. The purchaser is responsible for unloading and mounting all components of the equipment.

Document the serial number of the machine for future reference. The serial number is located on the side of the conveyor beside the drive guard cover.

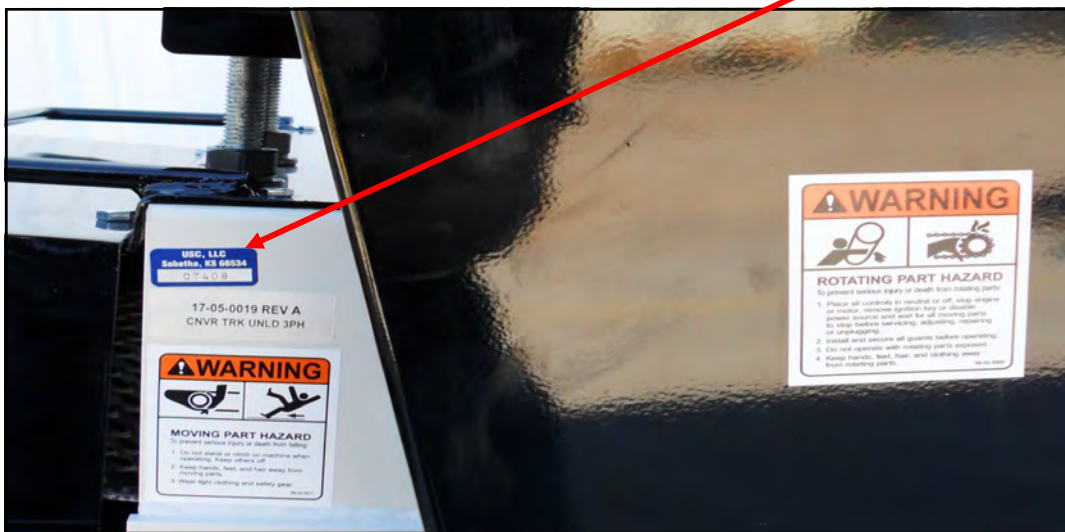

CONVEYOR SERIAL NUMBER: \_\_\_\_\_

# TABLE OF CONTENTS

<u>Section</u>	<u>Contents</u>	<u>Page #</u>
<b>Section A</b>	<b>Safety Instructions .....</b>	<b>5</b>
<b>Section B</b>	<b>Mechanical Operation .....</b>	<b>14</b>
	System Overview .....	15
	Controls .....	15
	Pre-Operation Checklist .....	16
	Operation.....	16
	Operating Hints .....	17
	Machine Break-in .....	18
<b>Section C</b>	<b>Troubleshooting .....</b>	<b>19</b>
<b>Section D</b>	<b>Maintenance.....</b>	<b>20</b>
	Belt Tensioning & Alignment .....	22
	Belt Replacement .....	23
	Drive Belt Tensioning & Alignment .....	24
<b>Section E</b>	<b>Mechanical Drawings .....</b>	<b>26</b>
<b>Section F</b>	<b>Limited Warranty .....</b>	<b>31</b>

# SAFETY INSTRUCTIONS

## SECTION A

Every year accidents in the work place maim, kill, and injure people. Although it may be impossible to prevent all accidents, with the right combination of training, operating practices, safety devices, and operator vigilance, the number of accidents can be significantly reduced. The purpose of this section is to educate equipment users about hazards, unsafe practices, and recommended hazard avoidance techniques.

### SAFETY WORDS AND SYMBOLS

It is very important that operators and maintenance personnel understand the words and symbols that are used to communicate safety information. Safety words, their meaning and format, have been standardized for U.S. manufacturers and published by the American National Standards Institute (ANSI). The European Community (E.C.) has adopted a different format based on the International Standards Organization (I.S.O.) and applicable machinery directives. Both formats are presented below. Graphic symbols are not standardized, but most manufacturers will use some variation of the ones seen in this manual.



Indicates an imminently hazardous situation which, if not avoided, **will** result in death or serious injury.



Indicates a potentially hazardous situation which, if not avoided, **could** result in death or serious injury.



Indicates a potentially hazardous situation which, if not avoided, **may** result in minor or moderate injury and/or property damage.



Provides additional information that the operator needs to be aware of to avoid a potentially hazardous situation.



**Mandatory Lockout Power Symbol.** Disconnect, lockout, and tagout electrical and other energy sources before inspecting, cleaning, or performing maintenance on this panel.



**International Safety Alert Symbol.** The exclamation point (!) surrounded by a yellow triangle indicates that an injury hazard exists. However, it does not indicate the seriousness of potential injury. The exclamation point (!) is also used with the DANGER, WARNING, and CAUTION symbols so the potential injury is indicated.



**Electrocution Hazard Symbol.** This symbol indicates that an electrocution hazard exists. Serious injury or death could result from contacting high voltage.



**International Electrocution Hazard.** This symbol indicates that an electrocution hazard exists. Serious injury or death could result from contacting high voltage.



**Mandatory Read Manual Action Symbol.** (I.S.O. format)  
This symbol instructs personnel to read the Operators Manual before servicing or operating the equipment.



**Mandatory Read Manual Action Symbol.** This symbol instructs personnel to read the Operators Manual before servicing or operating the equipment.



Notice is used to notify people of important installation, operation, or maintenance information which is not hazard related.



## **LOCKOUT / TAGOUT PROCEDURES**

Lockout/Tagout is the placement of a lock/tag on an energy isolating device in accordance with an established procedure. When taking equipment out of service to perform maintenance or repair work, always follow the lockout/tagout procedures as outlined in ANSI Z344.1 and/or OSHA Standard 1910.147. This standard “requires employers to establish a program and utilize procedures for affixing appropriate lockout devices or tagout devices to energy isolating devices and to otherwise disable machines or equipment to prevent unexpected energizing, startup, or release of stored energy in order to prevent injury to employees.”

## **CONTROLLED STOP**

This is the stopping of machine motion by reducing the electrical command signal to 0 (zero) once the stop signal has been recognized.

## **HAZARD REVIEW**



### **Electrocution Hazard**



Electrocution accidents are most likely to occur during maintenance of the electrical system or when working on or near exposed high voltage wiring. This hazard does not exist when the electrical power has been disconnected, properly locked, and tagged out.



### **Automatic Start Hazard**

This seed treating system is usually controlled by an automated system and may start without warning. Failure to properly disconnect, lockout, and tagout all energy sources of remotely controlled equipment creates a very hazardous situation and could cause injury or even death. PLEASE STAY CLEAR AND BE ALERT.



## TRUCK UNLOAD CONVEYOR

**YOU** are responsible for the **SAFE** operation and maintenance of your USC, LLC Seed Treating System. **YOU** must ensure that you and anyone else who is going to operate, maintain, or work around the Truck Unload Conveyor be familiar with the operating and maintenance procedures and related **SAFETY** information contained in this manual. This manual will take you step-by-step through your working day and alert you to good safety practices that should be adhered to while operating the Conveyor.

Remember, **YOU** are the key to safety. Good safety practices not only protect you, but also the people around you. Make these practices a working part of your safety program. Be certain that **EVERYONE** operating this equipment is familiar with the recommended operating and maintenance procedures and follows all the safety precautions. Most accidents can be prevented. Do not risk injury or death by ignoring good safety practices.

- Series 2000 Conveyor owners must give operating instructions to operators or employees before allowing them to operate the machine, and at least annually thereafter per OSHA (Occupational Safety and Health Administration) regulation 1928.57.
- The most important safety device on this equipment is a **SAFE** operator. It is the operator's responsibility to read and understand **ALL** Safety and Operating instructions in the manual and to follow them. All accidents can be avoided.
- A person who has not read and understood all operating and safety instructions is not qualified to operate the machine. An untrained operator exposes himself and bystanders to possible serious injury or death.
- Do not modify the equipment in any way. Unauthorized modification may impair the function and/or safety and could affect the life of the equipment.
- Think SAFETY! Work SAFELY!

### **GENERAL SAFETY**

1. Read and understand the Operator's Manual and all safety signs before operating, maintaining, adjusting or unplugging the Conveyor.
2. Only trained persons shall operate the seed treater. An untrained operator is not qualified to operate the machine.
3. Have a first-aid kit available for use should the need arise, and know how to use it.





## TRUCK UNLOAD CONVEYOR

4. Provide a fire extinguisher for use in case of an accident. Store in a highly visible place.
5. Do not allow children, spectators or bystanders within hazard area of machine.
6. Wear appropriate protective gear. This includes but is not limited to:



- A hard hat
- Protective shoes with slip resistant soles
- Protective goggles
- Heavy gloves
- Hearing protection
- Respirator or filter mask



7. Place all controls in neutral or off, stop motor, and wait for all moving parts to stop. Then disable power source before servicing, adjusting, repairing, or unplugging.



8. Review safety related items annually with all personnel who will be operating or maintaining the Conveyor.

### **OPERATING SAFETY:**

1. Read and understand the Operator's Manual and all safety signs before using.
2. Disconnect and disable electrical supply completely and wait for all moving parts to stop before servicing, adjusting, repairing or unplugging.
3. Clear the area of bystanders, especially children, before starting.
4. Be familiar with the machine hazard area. If anyone enters hazard area, shut down machine immediately. Clear the area before restarting.
5. Keep hands, feet, hair and clothing away from all moving and/or rotating parts.
6. Stay away from overhead obstructions and power lines during operation and transporting. Electrocutation can occur without direct contact.
7. Do not operate machine when any guards are removed.
8. Inspect welds and repair if needed.

### MAINTENANCE SAFETY

1. Review the Operator's Manual and all safety items before working with, maintaining or operating the conveyor.
2. Place all controls in neutral or off, stop motors, disable power source, and wait for all moving parts to stop before servicing, adjusting, repairing or unplugging.

3. Follow good shop practices:

Keep service area clean and dry.

Be sure electrical outlets and tools are properly grounded.

Use adequate light for the job at hand.

4. Keep hands, feet, hair and clothing away from all moving and/or rotating parts.



5. Clear the area of bystanders, especially children, when carrying out any maintenance and repairs or making any adjustments.
6. Before resuming work, install and secure all guards when maintenance work is completed.
7. Keep safety signs clean. Replace any sign that is damaged or not clearly visible.



- Think SAFETY! Work SAFELY!

REMEMBER—If Safety Signs have been damaged, removed, become illegible, or parts replaced without safety signs, new signs must be applied. New safety signs are available from your Authorized Dealer.

TRUCK UNLOAD CONVEYOR

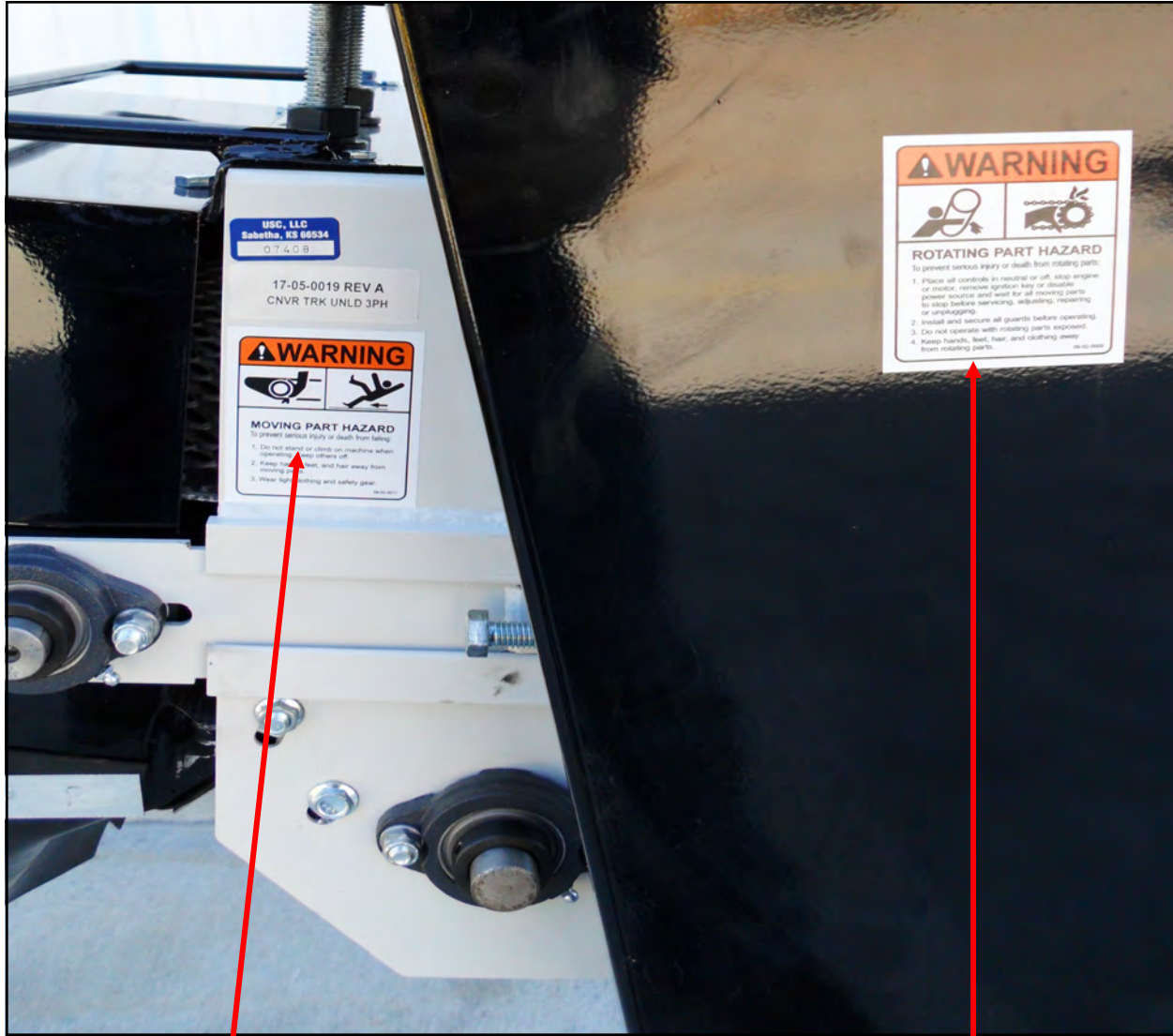





**REMEMBER**—If Safety Signs have been damaged, removed, become illegible, or parts replaced without safety signs, new signs must be applied. New safety signs are available from your Authorized Dealer.



Safety decal location  
(location may vary depending on motor model)



TRUCK UNLOAD CONVEYOR

**Notes:**

SECTION  
B**MECHANICAL OPERATION****OPERATING SAFETY**

1. Read and understand the Operator's Manual and all safety signs before using.
2. Electric motor drives: Disconnect and disable electrical supply completely and wait for all moving parts to stop before servicing, adjusting, repairing or unplugging.
3. Clear the area of bystanders, especially children, before starting.
4. Be familiar with machine hazard area. If anyone enters hazard areas, shut down machine immediately. Clear the area before restarting.
5. Keep hands, feet, hair and clothing away from all moving and/or rotating parts.
6. Do not allow riders on the Conveyor or transport vehicle when transporting.
7. Stay away from overhead obstructions and power lines during operation and transporting. Electro-cution can occur without direct contact.
8. Do not operate machine when any guards are removed.
9. Lower Conveyor to its lowest position before moving or transporting or when not in use.
10. Inspect lift cable before using Conveyor. Replace if frayed or damaged.
11. Make certain lift cable is properly seated in cable pulleys.
12. Be sure that conveyor is empty before raising or lowering.

The USC, LLC Truck Unload Conveyor is designed to efficiently move seed between a truck or seed tender to a seed facility. Power is provided by an electric motor. Be familiar with the machine before starting.

It is the responsibility of the owner and operator to read this manual and to train all other operators before they start working with the machine. In addition to the design and configuration of equipment, hazard control and accident prevention are dependent upon the awareness, concern, and prudence of personnel involved in the operation, transport, maintenance and storage of equipment or in the use and maintenance of facilities.

**NOTICE**

Follow all safety instructions exactly. Safety is everyone's business. By following recommended procedures, a safe working environment is provided for the operator, bystanders and the area around the worksite. Untrained operators are not qualified to operate the machine.

Many features incorporated into this machine are the result of suggestions made by customers like you. Read this manual carefully to learn how to operate the machine safely and how to set it to provide maximum efficiency. By following the operating instructions in conjunction with a good maintenance program, your conveyor will provide many years of trouble-free service.



## TRUCK UNLOAD CONVEYOR

### SYSTEM OVERVIEW

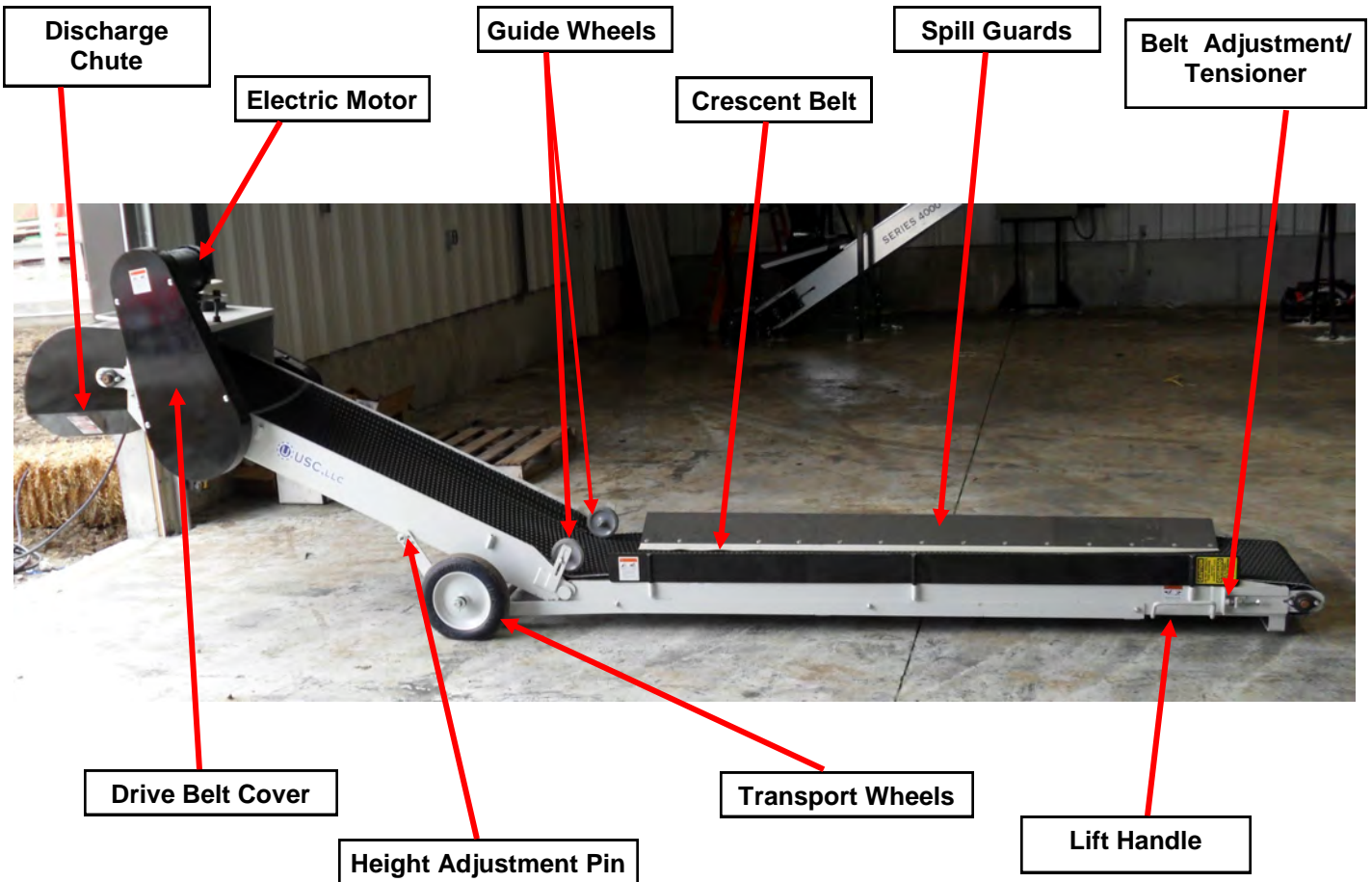

### CONTROLS

**Electric Drive:** Have a licensed electrician provide power to the machine per the National Electrical Code ANSI/NFPA 70 and local codes. For customer safety and ease of use, a motor on/off switch may be mounted on the conveyor.

### **PRE-OPERATION CHECKLIST**

Efficient and safe operation of the USC, LLC Truck Unload Conveyor requires that each operator reads and understands the operating procedures and all related safety precautions outlined in this section. A pre-operation checklist is provided for the operator. It is important for both the personal safety and maintaining the good mechanical condition of the Conveyor that this checklist is followed.

Before operating the Conveyor and each time thereafter, the following areas should be checked off:

1. Service the machine per the schedule outlined in Section D, Maintenance. (Page 21)
2. Use only an electric motor of adequate power to operate the machine.
3. Check that all guards are installed, secured and functioning as intended. Do not operate with missing or damaged shields.
4. Check worksite. Clean up working area to prevent slipping or tripping.
5. Check that drive belt and conveying belt are not frayed or damaged and that they are properly adjusted and aligned.
6. Check that discharge chute is free of obstructions.

### **OPERATION**

1. Clear the area of bystanders before starting the equipment.
2. Review the workplace Hazards schematic and use extra care when inside the hazard area, Keep all bystanders out of this area. Should anyone enter this area, stop the machine immediately.
3. Turn the Truck Unload Conveyor motor on and crank the truck seed gate open to begin conveying seed away from your truck.
4. To stop the conveyor shut the truck gate and run until the belt is clear of material. Then turn off the conveyor motor.

### **OPERATING HINTS**

- Always listen for any unusual sounds or noises. If any are heard, stop the machine and determine the source. Correct the problem before resuming work.
- Never allow anyone into the workplace hazard area. If anyone enters, stop immediately. Make them LEAVE before resuming work.
- Do not run the machine for long periods of time with no material on the belt. It increases the wear. Try to run the conveyor only when moving material.
- Always check and make sure the belt is properly aligned. Neglecting your belt may lead to wear and possible breakage.
- Always disconnect power from the conveyor when its not being operated in case of power surges.

### **EMERGENCY STOPPING**

Although it is recommended that the machine be emptied before stopping, in an emergency situation, stop or shutdown the power source immediately. Correct the emergency before resuming work.

### **RESTARTING**

When the machine is shut down inadvertently or for an emergency, the belt may still be covered with material. It may be necessary to tighten the drive belt slightly to handle the heavier-than-normal starting loads.

## **MACHINE BREAK-IN**

Although there are no operational restrictions on the conveyor when used for the first time, it is recommended that the following mechanical items be checked:

### **Before Starting**

1. Read the Conveyor Operator's Manual.
2. During the conveyors first few minutes of operation, check conveyor belt alignment to ensure belt is tracking correctly when running empty and also during loaded conditions.

### **After Operating for 1/2 Hour**

1. Re-torque fasteners and hardware.
2. Check that all safety decals are installed and legible. Apply new decals if required.
3. Check the drive belt tension and alignment. Tension or align as required.
4. Check the conveying belt tension and alignment. Tension or align as required.
5. Check that all guards are installed and working as intended.

### **After Operating for 5 Hours and 10 Hours**

1. Re-torque all bolts, fasteners and hardware.
2. Check that all guards are installed, secured and functioning as intended. Do not operate with missing or damaged shields.
3. Check safety decals. Install new ones if required.
4. Check the drive belt, and conveying belt tension and alignment. Tension or align as required.
5. Then go to the normal servicing and maintenance schedule as defined in the Maintenance Section.

SECTION  
C**TROUBLESHOOTING**

Below is a table describing the most frequent problems and solutions with the USC Truck Unload Conveyor. For further assistance, contact your local USC dealer.

Problem	Possible Cause	Solution
Conveyor will not run.	<ol style="list-style-type: none"> <li>1. Not turned on.</li> <li>2. Conveying belt loose.</li> <li>3. Drive belt loose.</li> </ol>	<ol style="list-style-type: none"> <li>1. Start power source or turn power on.</li> <li>2. Tighten and align belt.</li> <li>3. Tighten drive belt.</li> </ol>
Belt edge fraying.	<ol style="list-style-type: none"> <li>1. Belt not aligned.</li> </ol>	<ol style="list-style-type: none"> <li>1. Align and tension belt.</li> </ol>
Low conveying capacity.	<ol style="list-style-type: none"> <li>1. Slow operating speed.</li> <li>2. Conveyor belt slipping.</li> <li>3. Drive belt slipping.</li> </ol>	<ol style="list-style-type: none"> <li>1. Increase operating speed.</li> <li>2. Tighten belt.</li> <li>3. Set drive belt tension.</li> </ol>

**Unplugging**

In unusual moisture or material conditions, the machine can plug. When plugging occurs, follow this procedure:

1. Place all controls in neutral or off, stop motor, disable and lock out power source before unplugging.
2. Unbolt and remove the necessary conveyor covers.
3. Remove plugged material.
4. Install and secure conveyor covers.

**SECTION  
D****MAINTENANCE**

Proper maintenance of the USC Truck Unload Conveyor is critical for peak performance, reliability and accuracy of this system. The following is a guideline for the type of maintenance and servicing that should be performed on this unit. Your environment and uses may require additional maintenance and service beyond this list to assure a reliable and safe unit. The operator of this unit has ultimate responsibility to identify areas of concern and rectify them before they become a hazard or safety issue. There is no substitute for a trained, alert operator.



Do not put this unit into operation with any questionably maintained parts. Poor performance or a hazard may occur.

**FLUIDS AND LUBRICANTS****Grease**

Use an SAE multipurpose high temperature grease with extreme pressure (EP) performance. Also acceptable is an SAE multipurpose lithium-based grease.

**Storing Lubricants**

Your machine can operate at top efficiency only if clean lubricants are used. Use clean containers to handle all lubricants. Store them in an area protected from dust, moisture and other contaminants.

**GREASING**

Use a Maintenance Checklist to keep record of all scheduled maintenance.

1. Use a hand-held grease gun for all greasing.
2. Wipe grease fitting with a clean cloth before greasing to avoid injecting dirt and grit.
3. Replace and repair broken fittings immediately.

If fittings will not take grease, remove and clean thoroughly. Also clean lubricant passageway. Replace fitting if necessary.



**SERVICING INTERVALS**

**Every 40 hours or Weekly**

1. Check the conveyor belt tension and alignment.
2. Grease conveyor bearings.
  - Two bolt flanged bearings, tail roller bearings right and left (2 locations).
  - Two bolt flanged bearings, drive roller bearings right and left (2 locations).
  - Two bolt flanged bearings, jackshaft bearings right and left (2 locations).
3. Check the drive belt tension and alignment. The belts will deflect approximately 1/4 to 1/2 inch when properly tensioned. (right)
4. Remove black guard and check chain tension

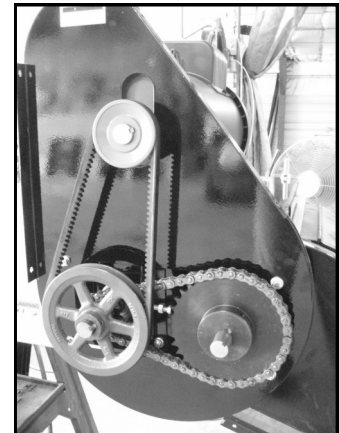
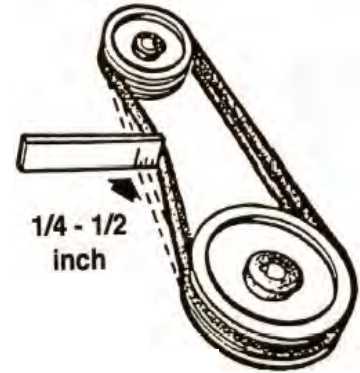

**Every 6 Months**

1. Examine transport wheels for wear and damage
2. Wash machine.
3. Grease the drive chain.

## **CONVEYING BELT TENSION AND ALIGNMENT**

A contoured crescent belt is used to convey material along the frame. The tension and alignment of the belt should be checked weekly, or more often if required, to be sure that it does not slip or run to one side. A properly tensioned belt will not slip when it is operating. Operating the belt with less slippage will increase the belt life and causes less stress on bearings, pulleys and shafts.

To maintain the belt, follow this procedure:

Place all controls in neutral or off, stop motor and disable power source before working on belt.

1. Use the take-up bolts located at the tail to set the tension of the belting.
2. If the belt needs to be tightened to prevent slippage, use the take-up adjustments on the tail end only.
3. The belt is tightened by turning both take-up adjustments an **equal** number of turns.
4. Use the drive roller to check the alignment. The belt should be centered.
5. Turn the belt 1/2 revolution when the belt is new and check the drive and tail roller. If out of alignment, the belt will move to the loose side. Loosen the bearing mounting bolts and use the bearing position bolts to set the position. Tighten mounting bolts.
6. Run and check again. Check frequently during the first few minutes of operation and then several times during the first 10 hours. The belt normally seats itself during the first 10 hours of operation and can be checked weekly after that.
7. The belt is properly aligned when the belt runs in the center of the head and tail rollers.

### **Tail Section Belt Tensioner**

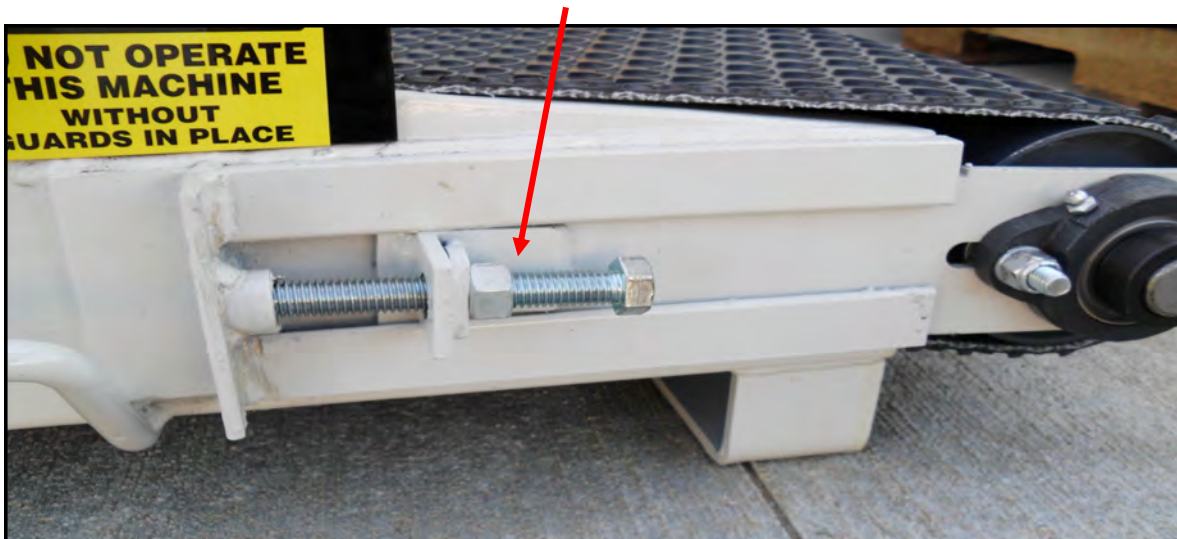

### **CONVEYING BELT ALIGNMENT**

1. A misaligned belt will track toward the loose side. Set the tracking by loosening the bearing mounts on the tight side and using the bearing position bolt to move the end of the head roller toward the tail. Tighten the bearing mount when the belt is centered on the head roller.
2. Run the belt and check the tracking again. Loosen the tight side slightly again if required. Repeat the adjusting and checking procedure until the belt centers on the input end roller and remains centered when running.
3. Always repeat this aligning procedure when installing a new belt. Check frequently during the first 10 hours of operation. After 10 hours, the belt is normally seated and checking the alignment can be done less frequently.



**Loosen bearing**

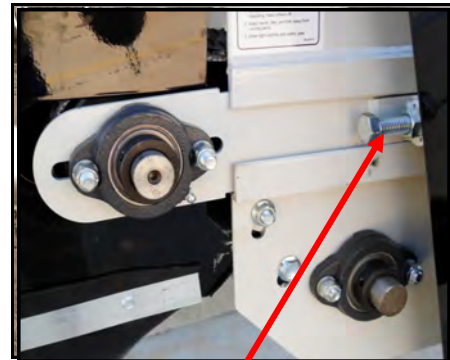

**Adjusting tracking**

### **BELT REPLACEMENT**

1. Rotate the belt until the seam is visible.
2. Move the tail roller to its loosest position.
3. Pull all the slack to the seam area.
4. Remove the wire connector and open the belt.
5. Attach one end of the replacement belt to the belt end being removed.
6. Pull the old belt out and the new belt will be threaded into place.
7. Disconnect the old belt.
8. Connect the ends of the new belt together and secure.
9. Set the belt tension.
10. Check and set the belt alignment

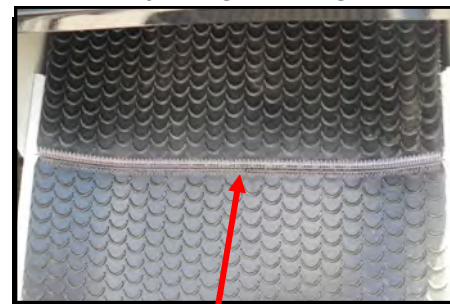

**Belt Seam**

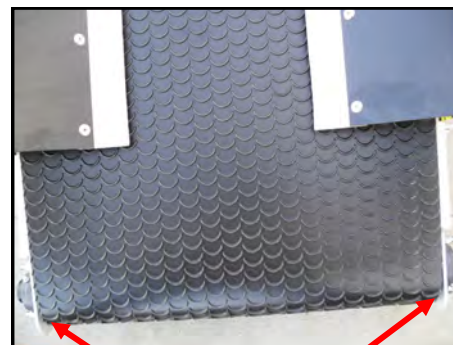

**Check alignment**

## **DRIVE BELT TENSION & ALIGNMENT**

Power to the conveying belt is transmitted through a V-belt. The V-belt drive system must be maintained at the proper belt tension and pulley alignment to obtain the desired performance and life. When maintaining the belt drive system for the electric drive model, follow this procedure:

**NOTICE** Turn motor off and unplug power cord or turn off power and lock out the master panel before starting maintenance on drive belt system.

### **Drive Belt Tension**

1. Push on the center of the belt span with a force of approximately 5 to 10 lbs.
2. The belts will deflect approximately 1/4 to 1/2 inch when properly tensioned.
3. Move the motor up, using the adjustment bolts, to set drive belt tension (right).
4. Close and secure guards.

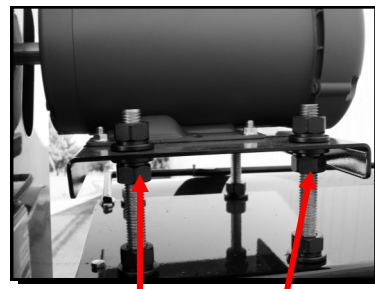

**Motor base adjustment**

### **Drive Belt Alignment**

1. Lay a straightedge across the pulley faces to check the alignment (right).
2. Use the pulley hub or the motor mounting plate slots to move the pulley to the required position for alignment.
3. Tighten hub bolts to secure pulley on shaft.
4. Check belt tension
5. Close and secure guards.

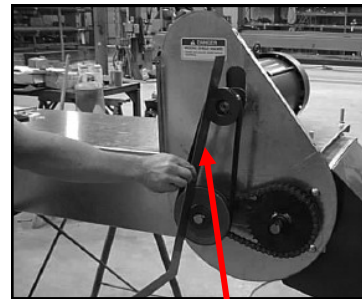

**Lay a straight edge across pulley faces**

### **Drive Belt Replacement**

1. Lower motor to its loosest position.
2. Remove old belt and replace with a new one.
3. Raise motor to set the belt tension.
4. Check pulley alignment. Adjust if required.
5. Close and secure guards.

When storing the USC Truck Unload Conveyor for long periods of time, the following procedure must be followed to reduce the chance of rust, corrosion and fatigue of the conveyor. You can also use these steps when storing the machine for the winter.

## NOTICE



A dust mask and protective rubber gloves shall be used when cleaning the machine.

1. Clear the area of bystanders, especially small children.
2. Thoroughly wash the entire machine to remove all dirt, mud, debris or residue.
3. Inspect all moving or rotating parts to see if anything has become entangled in them. Remove the entangled material.
4. Lubricate all grease fittings. Make sure that all grease cavities have been filled with grease to remove any water residue from the washing. This also protects the bearing seals.
5. Touch up all paint nicks and scratches to prevent rusting.
6. Cover the electric motor with a water proof tarpaulin and tie securely in place.
7. Inspect all caulking of conveyor covers for leaking and fix if necessary.
8. Do not allow children to play on or around the stored machine.







**Truck Unload Conveyor - Motor Plate**

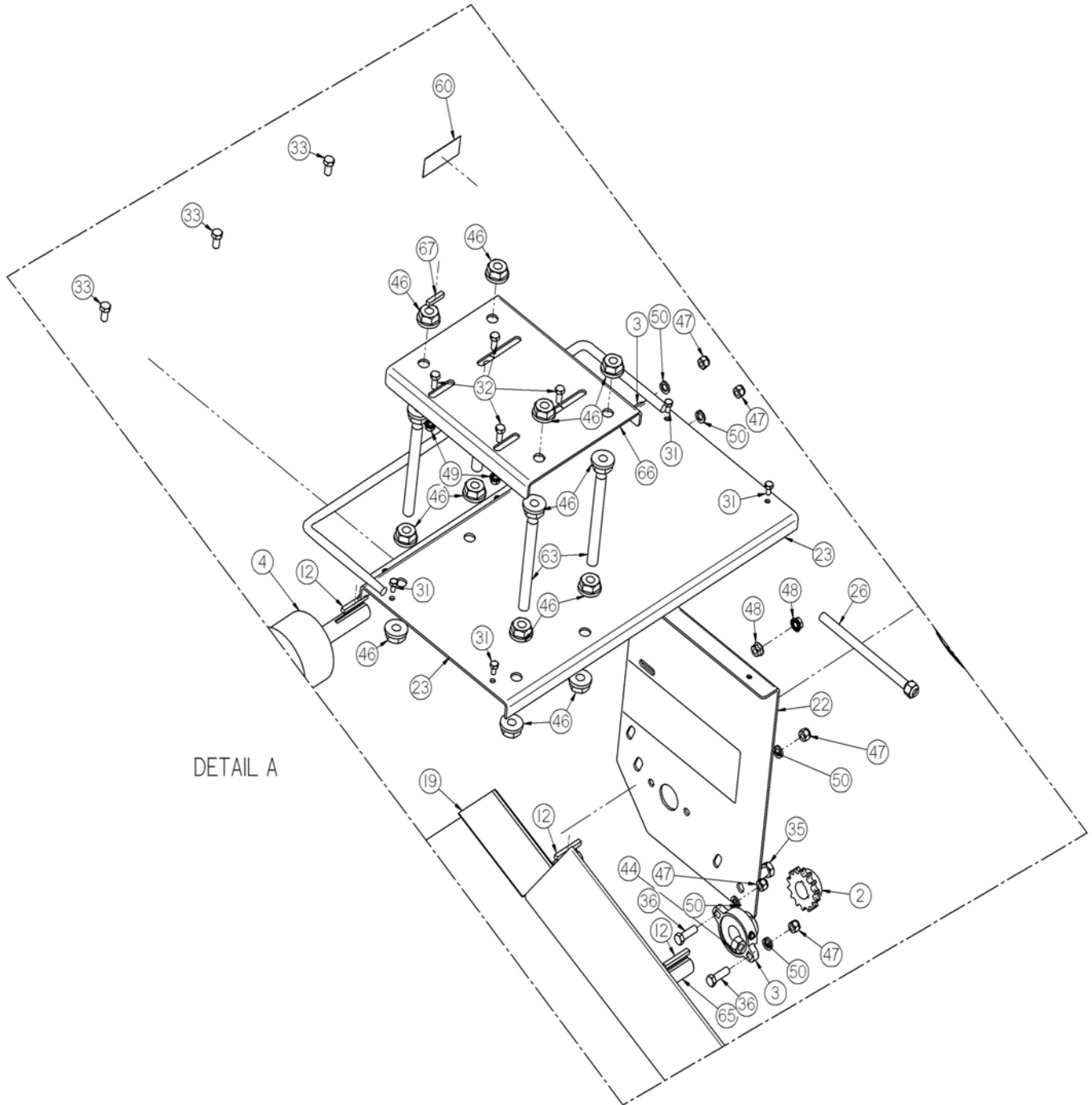

**Truck Unload Conveyor - Head Section**

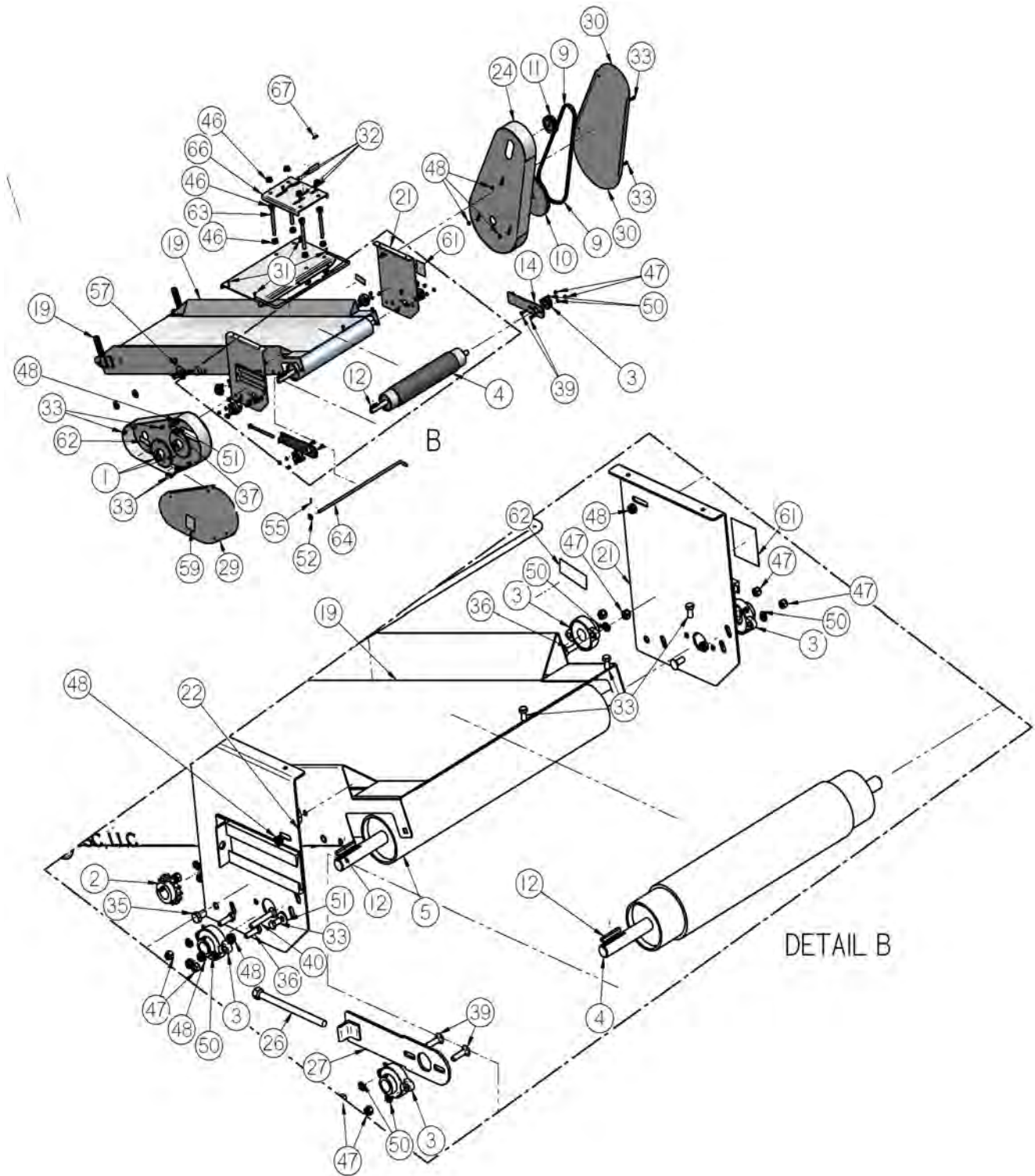

TRUCK UNLOAD CONVEYOR

**Truck Unload Conveyor - Parts List**

Item #	Part #	Title	Qty
1	01-02-0010	SPROCKET, 40 TOOTH, #40 - 1.00 BORE	2
2	01-02-0113	SPKT 14T 40P 1.00ID KWY	1
3	01-03-0042	BRG FLG MNT 1.000ID 2BOLT ECNTRC	8
4	01-06-0119	RLR HEAD DRV PLY TRK UNLD CNVR	1
5	01-06-0120	RLR HEAD GUIDE PLY TRK UNLD CNVR	1
6	01-06-0121	RLR TAIL GUIDE PLY TRK UNLD CNVR	1
7	01-06-0124	WHL 5DIA X 0.875WIDE 0.312 AXLE	2
8	01-06-0129	WHL 13 X 3.5 .625 BORE 6 IN HUB	2
9	01-08-0088	BELT B63 66 IN LONG NEOPRENE	1
10	01-08-0089	SHV BK95X1	1
11	01-08-0090	SHV BK40X7/8	1
12	01-10-0003	KEY .250 X 2.00 CS	4
13	05-03-0910	WDMT BODY TAIL SECT TRK UNLD	1
14	05-03-0911B	WDMT TNSNR SLIDER TRK UNLD	3
15	05-03-0914	ASSY TRK UNLOAD GUARD BELT WIPER	2
16	05-03-0917	WDMT UNCG TAIL TRK UNLOAD	1
17	05-03-0918	WDMT UNCG ADJUSTER TRK UNLOAD	1
18	05-03-0919	WDMT HEAD FINGER GUARD TRK UNLD	1
19	05-03-0920	WDMT BODY HEAD SECT TRK UNLD	1
20	05-03-0922	WDMT PIVOT PIN TRK UNLD	1
21	05-03-0923	WDMT RH HEAD SIDE PLT TRK UNLD	1
22	05-03-0924	WDMT LH HEAD SIDE PLT TRK UNLD	1
23	05-03-0925	WDMT HEAD TOP PLT TRK UNLD	1
24	05-03-0927	WDMT SHV GRD TRK UNLD	1
25	05-03-0928	WDMT SPKT CHAIN GRD TRK UNLD	1
26	05-03-0932	WDMT TNSNR SLIDER BOLT TRK UNLD	1
27	05-03-0935	WDMT TNSNR SLIDER TRK UNLD	1
28	05-03-0983	ASSY HEAD COVER RBBR TRK UNLD	1
29	05-10-3781	PSM SPKT CHAIN GRD TRK UNLD	1
30	05-10-3782	PSM SHV GRD TRK UNLD	1
31	06-01-0004	BOLT .250-20 X .500 ZP GR5	4
32	06-01-0010	BOLT .313-18 X 0.75 ZP GR5	4
33	06-01-0015	BOLT .375-16 X 0.75 ZP GR5	15
34	06-01-0016	BOLT .375-16 X 1.00 ZP GR5	6

TRUCK UNLOAD CONVEYOR

**Truck Unload Conveyor - Parts List**

Item #	Part #	Title	Qty
35	06-01-0024	BOLT .500-13 X .750 ZP GR5	2
36	06-01-0053	BOLT .375-16 X 1.25 ZP GR5	8
37	06-01-0071	BOLT, .375-16 X 2 1/2 ZP G5 FULL THREAD	5
38	06-01-0115	BOLT CRG .375-16 X 1.00 ZP GR5	1
39	06-01-0128	BOLT, CARRIAGE, .375-16 X 1.50 G5 ZP	8
40	06-01-0154	BOLT CRG .375-16 X 2.50 FTH ZP GR5	1
41	06-01-0157	BOLT, .500-13 X 4" UNC ZP GRADE 5 fth	3
42	06-01-0195	BOLT .500-13 X 2.00 ZP GR8	2
43	06-01-0227	BOLT 0.312-18 X 6.5 ZP	2
44	06-02-0004	NUT FULL .500-13 ZP GR5	4
45	06-02-0066	NUT LOCK .500-13 ZP GR8 NYLON IN	2
46	06-02-0075	NUT FLG .625-11 UNC BO G5	16
47	06-03-0003	NUT NYL LOCK .375-16 ZP GR5	16
48	06-03-0014	NUT LOCK FLG .375-16 ZP GR5	18
49	06-03-0019	NUT LOCK FLG .3125-18 ZP GR5	8
50	06-04-0003	WSHR LOCK SPLT .375 ZP	16
51	06-05-0004	WSHR FLAT .375 ZP	6
52	06-05-0005	WSHR FLAT .500 ZP	1
53	06-05-0006	WASHER, .625 FLAT ZP	4
54	06-05-0007	WASHER, .750 FLAT ZP	1
55	06-09-0013	1/8" X 3/4" COTTER PIN	1
56	06-09-0023	.188 X 2.00 ZP COTTER PIN	3
57	09-01-0042	ATWL LBL USC, LLC 3" X 15" PRO-CUT	2
58	09-02-0002	ATWK LBL DANGER GUARDS	2
59	09-02-0009	ATWK LBL WARNING ROTATING PARTS	2
60	09-02-0010	ATWK LBL DANGER ELECTROCUTION	1
61	09-02-0011	ATWK LBL WARNING MOVING PARTS	5
62	09-02-0012	ATWK LBL DANGER MISSING SHIELD	5
63	101AE8	ROD MOTOR MOUNT SPACER TRK UNLD	4
64	101B70	BAR ADJUSTER HANDLE TRK UNLD	1
65	101B77	BAR PULLEY TRK UNLD	1
66	101B87	PSM MOTOR MOUNT PLATE TRK UNLD	1
67	106-3-2036	KEY .250 X 1.25 CS	1
68	11-02-0081	BELT CNVR TRK UNLD 24" WIDE 362" LG	1

SECTION  
F**LIMITED WARRANTY****USC, LLC. (Manufacturer) warrants its seed treating equipment as follows:**

1. **Limited Warranty:** Manufacturer warrants that the Products sold hereunder will be free from defects in material and workmanship for a period of 12 months from date of shipment. If the Products do not conform to this Limited Warranty during the warranty period, Buyer shall notify Manufacturer in writing of the claimed defects and demonstrate to Manufacturer satisfaction that said defects are covered by this Limited Warranty. If the defects are properly reported to Manufacturer within the warranty period, and the defects are of such type and nature as to be covered by this warranty, Manufacturer shall, at its expense, furnish replacement Products or, at Manufacturer's option, replacement parts for the defective products. Shipping and installation of the replacement Products or replacement parts shall be at the Buyer's expense.

2. **Other Limits:** THE FOREGOING IS IN LIEU OF ALL OTHER WARRANTIES, EXPRESSED OR IMPLIED, INCLUDING BUT NOT LIMITED TO THE IMPLIED WARRANTIES OF MERCHANTABILITY AND FITNESS FOR A PARTICULAR PURPOSE. Manufacturer does not warrant against damages or defects arising from improper installation (where installation is by persons other than Manufacturer), against defects in products or components not manufactured by Manufacturer, or against damages resulting from such non-Manufacturer made products or components. Manufacturer passes on to the Buyer the warranty it received (if any) from the maker of such non-Manufacturer made products or components.

This warranty also does not apply to Products upon which repairs and/or modifications have been effected or attempted by persons other than pursuant to written authorization by Manufacturer. Manufacturer does not warrant against casualties or damages resulting from misuse and/or abuse of product(s), acts of nature, effects of weather, including effects of weather due to outside storage, accidents, or damages incurred during transportation by common carrier.

3. **Exclusive Obligation:** THIS WARRANTY IS EXCLUSIVE. The sole and exclusive obligation of Manufacturer shall be to repair or replace the defective Products in the manner and for the period provided above. Manufacturer shall not have any other obligation with respect to the Products or any part thereof, whether based on contract, tort, strict liability or otherwise. Under no circumstances, whether based on this Limited Warranty or otherwise, shall Manufacturer be liable for incidental, special, or consequential damages.

4. **Other Statements:** Manufacturer's employees or representatives' oral or other written statements do not constitute warranties, shall not be relied upon by Buyer, and are not a part of the contract for sale or this limited warranty.

5. **Return Policy:** Approval is required prior to returning goods to USC, LLC. A restocking fee will apply.

6. **Entire Obligation:** This Limited Warranty states the entire obligation of Manufacturer with respect to the Products. If any part of this Limited Warranty is determined to be void or illegal, the remainder shall remain in full force and effect.



**USC, LLC**

2320 124th road

Sabetha, Ks 66534

PHONE: (785) 431-7900

FAX: (785) 431-7950

EMAIL: [sales-team@uscllc.com](mailto:sales-team@uscllc.com)

WEB: [www.uscllc.com](http://www.uscllc.com)

---