

SEMI-AUTOMATED 4 PUMP CONTROLLER

Operators Manual

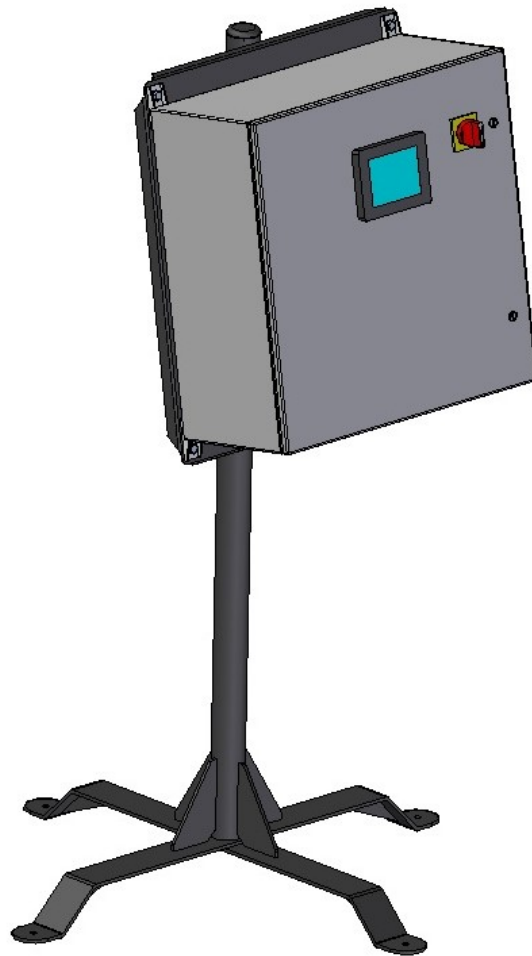

Software Release: S4PC v2.1

Document: TD-09-06-1036

Revision: D

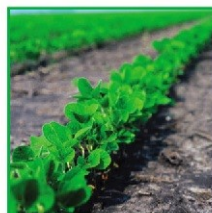

INTRODUCTION

Thank you for choosing USC, LLC for your equipment needs. We appreciate your business and will work diligently to ensure that you are satisfied with your choice.

OVERVIEW

The purpose of this manual is to provide you with the basic information needed to install, operate and maintain the Semi-Automated 4 Pump Controller. It does not hold USC, LLC liable for any accidents or injuries that may occur.

The technical information provided in this document is based on extensive testing under controlled conditions at the USC research and development facility. This information is given without guarantee as the conditions of operation and storage of the equipment are beyond our control. Variables such as temperature, humidity, viscosity of chemical products and changes in seed size or variety may all effect the accuracy of application and seed coverage. Periodically check the equipment calibration while treating and make adjustments as required. This will insure the optimum seed coverage.

OPERATOR RESPONSIBILITIES

As the purchaser/owner/operator of this equipment and control system, you have an obligation to install, operate, and maintain the equipment in a manner that minimizes the exposure of people in your care to any potential hazards inherent in using this equipment. It is critical that the owner of this equipment:

- Has a clear and documented understanding of the process this machine is being used in and of any resulting hazards or special requirements arising from this specific application.
- Allow only properly trained and instructed personnel to install, operate or service this equipment.
- Maintain a comprehensive safety program involving all who work with this machine and other associated process equipment.
- Establish clear areas of staff responsibility (e.g. operation, setup, sanitation, maintenance, and repairs).
- Provide all personnel with necessary safety equipment.
- Periodically inspect the equipment to insure that the doors, covers, guards, and safety devices are in place and functioning, that all safety instructions and warning labels are intact and legible, and that the equipment is in good working order.
- In addition to the operating instructions, observe and enforce the applicable legal and other binding regulations, national and local codes.

SEMI-AUTOMATED 4 PUMP CONTROLLER

As the person with the most to gain or lose from working safely, it is important that you work responsibly and stay alert. By following a few simple rules, you can prevent an accident that could injure or kill you or a co-worker.

- Disconnect, lockout, and tagout electrical and all other energy sources before inspecting, cleaning, servicing, repairing, or any other activity that would expose you to the hazards of electrical shock.
- Do not operate, clean, or service this equipment until you have read and understood the contents of this manual. If you do not understand the information in this manual, bring it to the attention of your supervisor, or call USC at (785) 431-7900 for assistance.
- Any operator who is known or suspected to be under the influence of alcohol or drugs should not be allowed to operate the equipment.
- Understand and follow the safety practices required by your employer and this manual.
- **PAY ATTENTION** to what you and other personnel are doing and how these activities may affect your safety.
- **Failure to follow these instructions may result in serious personal injury or death.**

RECEIVING YOUR EQUIPMENT

As soon as the equipment is received, it should be carefully inspected to make certain that it has sustained no damage during shipment and that all items listed on the packing list are accounted for. If there is any damage or shortages, the purchaser must immediately notify USC, LLC. Ownership passes to purchaser when the unit leaves the USC, LLC. premises. The purchaser is responsible for unloading and mounting all components of the equipment.

Document the serial number of the machine for future reference. The serialization label is located on the in the upper right hand corner of the control panel.

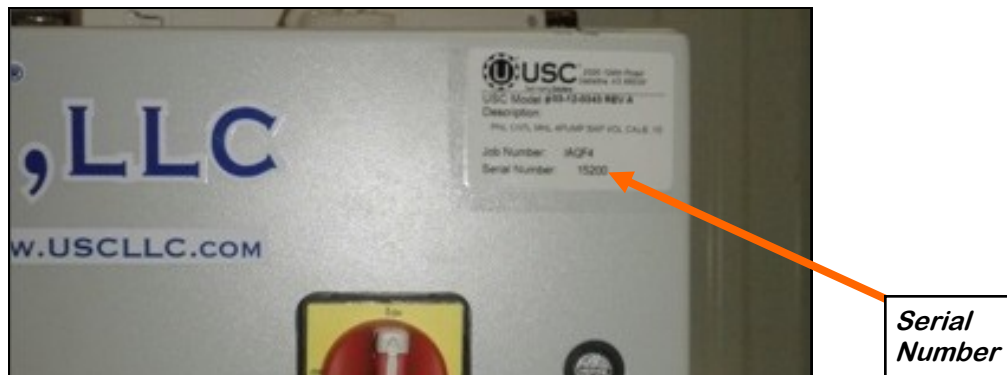

SERIAL NUMBER: _____

TABLE OF CONTENTS

<u>Section</u>	<u>Contents</u>	<u>Page #</u>
Section A	Safety Instructions	5
Section B	Installation	14
	Placement & Inspection.....	15
	Setting DC Pump Motors.....	16
	DC Pump Board Settings	19
Section C	Mechanical Operation	21
	Control Panel Overview.....	21
Section D	Electrical Operation	22
	Start Up Screen	23
	Main Screen	24
	Chemicals / Recipe Selection or Editing Screen.....	26
	Chemical Editing Screen.....	28
	Calibration Calculator Screen	29
	Recipe Editing Screen.....	30
	Flow Rate Set Up Screens	31
	Overview Screen	33
	H-O-A Screen.....	34
	Utilities Screen	35
	Tools & Options Screen	36
	Security Screen	38
	Setpoints Screen	39
	Custom PID Settings Screen	40
Section E	Calibration	41
	Initial Pump Calibration (USC Pump Stands)	41
	Flow Meter Calibration (USC Pump Stands)	42
Section F	Troubleshooting	43
Section G	Maintenance	44
Section H	Storage	47
Section I	Mechanical Drawings	48
Section J	Limited Warranty	51

SAFETY INSTRUCTIONS

SECTION A

Every year accidents in the work place maim, kill and injure people. Although it may be impossible to prevent all accidents, with the right combination of training, operating practices, safety devices, and operator vigilance, the number of accidents can be significantly reduced. The purpose of this section is to educate equipment users about hazards, unsafe practices, and recommended hazard avoidance techniques.

If any of the required regularly scheduled maintenance is located above the reach of the operator, they should follow the companies normal safe practices of reaching that particular height, utilizing the companies specified equipment and following normal safety precautions.

When working with treatment chemicals, operators should always wear protective gloves, safety glasses, and follow the companies safety precautions in the case of any spillage or operator contamination.

SAFETY WORDS AND SYMBOLS

It is very important that operators and maintenance personnel understand the words and symbols that are used to communicate safety information. Safety words, their meaning and format, have been standardized for U.S. manufacturers and published by the American National Standards Institute (ANSI). The European Community (E.C.) has adopted a different format based on the International Standards Organization (I.S.O.) and applicable machinery directives. Both formats are presented below. Graphic symbols are not standardized, but most manufacturers will use some variation of the ones seen in this manual.

MOTS ET SYMBOLES SÉCURITÉ

Il est très important que les opérateurs et le personnel d'entretien à comprendre les mots et les symboles qui sont utilisés pour communiquer des informations de sécurité. Mots de sécurité, de leur signification et le format, ont été normalisés pour les fabricants américains et publié par l' American National Standards Institute (ANSI). La Communauté européenne (CE) a adopté un format différent sur la base de l'Organisation internationale de normalisation (ISO) et des directives de machines applicables. Les deux formats sont présentés ci-dessous. Les symboles graphiques ne sont pas standardisés, mais la plupart des fabricants utilisent une variante de ceux observés dans ce manuel.



Indicates an imminently hazardous situation which, if not avoided, **will** result in death or serious injury.



Indique une situation extrêmement dangereuse qui, si pas évitée, entraînera la mort ou des blessures graves.



Indicates a potentially hazardous situation which, if not avoided, **could** result in death or serious injury.



Indique une situation potentiellement dangereuse qui, si pas évitée, pourrait entraîner la mort ou des blessures graves.



Indicates a potentially hazardous situation which, if not avoided, **may** result in minor or moderate injury and/or property damage.



Indique une situation potentiellement dangereuse qui, si pas évitée, peut entraîner des blessures mineures ou modérées et / ou des dommages.



Provides additional information that the operator needs to be aware of to avoid a potentially hazardous situation.



Fournit des informations supplémentaires que l'opérateur doit être conscient de d'éviter une situation potentiellement dangereuse.



Notice is used to notify people of important installation, operation or maintenance information which is not hazard related.



Avis est utilisé pour informer les gens des informations de maintenance qui ne est pas danger lié importante installation, l'exploitation ou.



Mandatory Lockout Power Symbol. Disconnect, lockout and tagout electrical and other energy sources before inspecting, cleaning or performing maintenance on this panel.

Symbole de puissance verrouillage obligatoire. Débranchez, de verrouillage et de déconsignation énergie électrique et d'autres sources avant d'inspecter, de nettoyage ou de la maintenance de ce panneau.



International Safety Alert Symbol. The exclamation point (!) surrounded by a yellow triangle indicates that an injury hazard exists. However, it does not indicate the seriousness of potential injury. The exclamation point (!) is also used with the DANGER, WARNING and CAUTION symbols so the potential injury is indicated.

Sécurité Symbole International Alert . Le point d'exclamation (!) Entouré par un triangle jaune indique que un risque de blessure existe . Cependant, il ne indique pas la gravité des blessures potentielles. Le point d'exclamation (!) Est également utilisé avec les symboles DANGER, AVERTISSEMENT et ATTENTION de sorte que le risque de blessure est indiqué.



Electrocution Hazard Symbol. This symbol indicates that an electrocution hazard exists. Serious injury or death could result from contacting high voltage.

Symbole de danger d'électrocution . Ce symbole indique qu'un danger d'électrocution existe. Des blessures graves ou la mort pourraient résulter de contact haute tension.



International Electrocution Hazard. This symbol indicates that an electrocution hazard exists. Serious injury or death could result from contacting high voltage.

Danger d'électrocution international. Ce symbole indique qu'un danger d'électrocution existe. Des blessures graves ou la mort pourraient résulter de contact haute tension.



Mandatory Read Manual Action Symbol. (I.S.O. format) This symbol instructs personnel to read the Operators Manual before servicing or operating the equipment.

Obligatoire Lire Symbole d'action Manuel. (Format ISO)
Ce symbole indique le personnel de lire le manuel de l'opérateur avant de réparer ou d'utiliser l'équipement.



Mandatory Read Manual Action Symbol. This symbol instructs personnel to read the Operators Manual before servicing or operating the equipment.

Obligatoire Lire Symbole d'action Manuel . Ce symbole indique le personnel de lire le manuel de l'opérateur avant de réparer ou d'utiliser l'équipement.

LOCKOUT / TAGOUT PROCEDURES

Lockout/Tagout is the placement of a lock/tag on an energy isolating device in accordance with an established procedure. When taking equipment out of service to perform maintenance or repair work, always follow the lockout / tagout procedures as outlined in ANSI Z344.1 and/or OSHA Standard 1910.147. This standard “requires employers to establish a program and utilize procedures for affixing appropriate lockout devices or tagout devices to energy isolating devices and to otherwise disable machines or equipment to prevent unexpected energizing, start-up, or release of stored energy in order to prevent injury to employees.”

LES PROCEDURES DE VERROUILLAGE / ETIQUETAGE

Verrouillage / étiquetage est le placement d'un verrouillage / tag sur un dispositif d'isolement de l'énergie conformément à une procédure établie. Lors de la prise hors service des équipements pour effectuer la maintenance ou de réparation, toujours suivre les procédures de verrouillage / débranchement comme indiqué dans la norme ANSI Z344.1 et / ou la norme OSHA 1910.147. Cette norme "oblige les employeurs à établir un programme et appliquer des procédures pour la fixation des dispositifs de verrouillage appropriés ou des dispositifs de consignation à l'énergie dispositifs d'isolement et d' autres machines ou équipements désactiver pour éviter énergisant inattendu, start-up, ou la libération de l'énergie stockée dans le but de prévenir les blessures aux employés."

HAZARD REVIEW

RISQUE EXAMEN

Electrocution Hazard



Electrocution accidents are most likely to occur during maintenance of the electrical system or when working on or near exposed high voltage wiring. This hazard does not exist when the electrical power has been disconnected, properly locked, and tagged out.

Risque d'électrocution

Les accidents d'électrocution sont les plus susceptibles de se produire lors de la maintenance du système électrique ou pour travailler sur ou à proximité du câblage haute tension exposé. Ne existe pas ce danger lorsque l'alimentation électrique a été déconnecté, bien verrouillé et étiquetés sur.

Automatic Start Hazard



! WARNING

This equipment may be controlled by an automated system and may start without warning. Failure to properly disconnect, lockout, and tagout all energy sources of remotely controlled equipment creates a very hazardous situation and could cause injury or even death. PLEASE STAY CLEAR AND BE ALERT.

Démarrer danger automatique

! AVERTISSEMENT

Cet équipement peut être contrôlé par un système automatisé et peut démarrer sans avertissement. Sources de l'équipement contrôlé à distance non débranché correctement, lock-out, et tous de consignation énergie crée une situation très dangereuse et pourrait causer des blessures ou même la mort. Se IL VOUS PLAÎT rester à l'écart et d'être vigilant.

SEMI-AUTOMATED 4 PUMP CONTROLLER

YOU are responsible for the **SAFE** operation and maintenance of your USC, LLC Equipment. **YOU** must ensure that you and anyone else who is going to operate, maintain or work around the Equipment be familiar with the operating and maintenance procedures and related **SAFETY** information contained in this manual. This manual will take you step-by-step through your working day and alert you to good safety practices that should be adhered to while operating the Equipment.

Remember, **YOU** are the key to safety. Good safety practices not only protect you, but also the people around you. Make these practices a working part of your safety program. Be certain that **EVERYONE** operating this equipment is familiar with the recommended operating and maintenance procedures and follows all the safety precautions. Most accidents can be prevented. Do not risk injury or death by ignoring good safety practices.

- Equipment owners must give operating instructions to operators or employees before allowing them to operate the machine, and at least annually thereafter per OSHA (Occupational Safety and Health Administration) regulation 1928.57.
- The most important safety device on this equipment is a **SAFE** operator. It is the operator's responsibility to read and understand **ALL** Safety and Operating instructions in the manual and to follow them. All accidents can be avoided.
- A person who has not read and understood all operating and safety instructions is not qualified to operate the machine. An untrained operator exposes himself and bystanders to possible serious injury or death.
- Do not modify the equipment in any way. Unauthorized modification may impair the function and/or safety and could affect the life of the equipment.
- Think SAFETY! Work SAFELY!

GENERAL SAFETY

1. Read and understand the operator's manual and all safety labels before operating, maintaining, adjusting or unplugging the Equipment.
2. Only trained persons shall operate the Equipment. An untrained operator is not qualified to operate the machine.
3. Have a first-aid kit available for use should the need arise, and know how to use it.

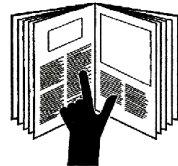

SEMI-AUTOMATED 4 PUMP CONTROLLER

4. Provide a fire extinguisher for use in case of an accident. Store in a highly visible place.
5. Do not allow children, spectators or bystanders within hazard area of machine.
6. Wear appropriate protective gear. This includes but is not limited to:
 - A hard hat
 - Protective shoes with slip resistant soles
 - Protective goggles
 - Heavy gloves
 - Hearing protection
 - Respirator or filter mask
7. Place all controls in neutral or off, stop motor, and wait for all moving parts to stop. Then disable power source before servicing, adjusting, repairing, or unplugging.
8. Review safety related items annually with all personnel who will be operating or maintaining the Equipment.



OPERATING SAFETY:

1. Read and understand the operator's manual and all safety labels before using.
2. Disconnect and disable electrical supply completely and wait for all moving parts to stop before servicing, adjusting, repairing or unplugging.
3. Clear the area of bystanders, especially children, before starting.
4. Be familiar with the machine hazard area. If anyone enters hazard area, shut down machine immediately. Clear the area before restarting.
5. Keep hands, feet, hair and clothing away from all moving and/or rotating parts.
6. Stay away from overhead obstructions and power lines during operation and transporting. Electrocutation can occur without direct contact.
7. Do not operate machine when any guards are removed.
8. Inspect welds and repair if needed.

PLACEMENT SAFETY

1. Move only with the appropriate equipment
2. Stay away from overhead power lines when moving equipment. Electrocutation can occur without direct contact.
3. Be familiar with machine hazard area. If anyone enters hazard areas, shut down machine immediately. Clear the area before restarting.
4. Operate the equipment on level ground free of debris. Anchor the equipment to prevent tipping or upending.



Before placement of the equipment, be sure that ground is reasonably level. The equipment may topple or work improperly if the ground is too uneven, damaging the equipment and / or causing personal injury.



Avant de placement de l'équipement, assurez-vous que sol est relativement plat. L'équipement peut tomber ou mal fonctionner si le sol est trop inégale, endommager l'équipement et / ou causer des blessures.

MAINTENANCE SAFETY

1. Review the operator's manual and all safety items before working with, maintaining or operating the equipment .
2. Place all controls in neutral or off, stop motors, disable power source, and wait for all moving parts to stop before servicing, adjusting, repairing or unplugging.
3. Follow good shop practices:
Keep service area clean and dry.
Be sure electrical outlets and tools are properly grounded.
Use adequate light for the job at hand.
4. Keep hands, feet, hair and clothing away from all moving and/or rotating parts.
5. Clear the area of bystanders, especially children, when carrying out any maintenance and repairs or making any adjustments.
6. Before resuming work, install and secure all guards when maintenance work is completed.
7. Keep safety labels clean. Replace any sign that is damaged or not clearly visible.



SAFETY LABELS

1. Keep safety labels clean and legible at all times.
2. Replace safety labels that are missing or have become illegible.
3. Replaced parts that displayed a safety label should also display the current label.
4. Replacement safety labels are available. Contact USC at (785) 431-7900 .

How to Install Safety Labels:

- Be sure that the installation area is clean and dry.
- Be sure temperature is above 50°F (10°C).
- Decide on the exact position before you remove the backing paper.
- Remove the smallest portion of the split backing paper.
- Align the sign over the specified area and carefully press the small portion with the exposed sticky backing in place.
- Slowly peel back the remaining paper and carefully smooth the remaining portion of the sign in place.
- Small air pockets can be pierced with a pin and smoothed out using the piece of sign backing paper.



WARNING

Located on the USC equipment you will find safety labels. Always be sure to read and follow all directions on the labels.

! AVERTISSEMENT

Situé sur l'équipement USC vous trouverez des étiquettes de sécurité. Veuillez à toujours lire et suivre toutes les instructions sur les étiquettes.



WARNING

Guards provided with USC equipment are to remain in place during operation.

! AVERTISSEMENT

Gardes fournis avec des équipements USC doivent rester en place pendant le fonctionnement.

SECTION
B**INSTALLATION**

HIGH VOLTAGE ~ Always disconnect the power source before working on or near the control panel or lead wires.



HAUTE TENSION ~ Toujours débrancher la source d'alimentation avant de travailler sur ou près du panneau de commande ou les câbles.



HIGH VOLTAGE ~ Use insulated tools when making adjustments while the controls are under power.



HAUTE TENSION ~ Utilisez des outils isolés lors des réglages, tandis que les commandes sont sous tension.



Permanent installation may require additional electrical cords, chemical tubing, and air lines, since each installation is unique.



Installation permanente peut exiger cordons électriques, des tubes supplémentaires chimique, et les conduites d'air, puisque chaque installation est.

USC equipment may operate within a Group II, Division 2, Class G hazardous area which contains seed dust. If so, the equipment must be certified for use in this area. To avoid the possibility of an explosion ignited by static electricity, all USC equipment should be grounded by attaching a bonding strip to the metal frame and securing that strip to the factory ground point.

If labeled accordingly, USC products are designed to comply with CSA 22.1 for use in a Class II, Division 2, Group G environment. When connecting the USC system power cord into a power supply, first determine if the supply is also within the hazardous area where the USC system is located. If so, we recommend that the power be hard wired into the source. Do not use a standard electrical plug for this purpose. For other acceptable methods of connecting to a power source, or any other additional miscellaneous equipment to the USC system within a hazardous location, please consult CSA 22.1, Section 18-200 and 18-274. Review the appropriate section and ensure compliance with one of the options given.

When connecting to USC equipment from a remote location, and the USC equipment is in a hazardous Class II, Group G environment, customers are advised to follow the requirements within CSA 22.2 no. 25. More details may also be found in CSA 22.1 18-252 (wiring methods). There are various options covered within this section for wiring in a Class II, Group G (dust) environment. Select the best method suited for your specific location.

SEMI-AUTOMATED 4 PUMP CONTROLLER

équipements USC peut fonctionner dans un Groupe II, Division 2, Classe G zone dangereuse qui contient la poussière des semences. Si oui, l'équipement doit être certifié pour une utilisation dans ce domaine. Pour éviter la possibilité d'une explosion enflammé par l'électricité statique, tous les équipements USC doit être mis à la terre en attachant une bande de liaison à la structure métallique et la sécurisation cette bande au point de masse du fabricant.

Si étiquetés en conséquence, les produits USC sont conçus pour être conformes à la norme CSA 22.1 pour une utilisation dans une Classe II, Division 2, Groupe G environnement. Lors du raccordement du USC alimentation du système cordon dans une alimentation, d'abord déterminer si l'offre est également dans la zone dangereuse où se trouve le système USC. Si oui, nous recommandons que le pouvoir soit câblé dans la source. Ne pas utiliser une prise électrique standard à cet effet. Pour les autres méthodes acceptables de se connecter à une source d'alimentation, ou tout autre matériel divers supplémentaire au système USC dans un endroit dangereux, se il vous plaît consulter la norme CSA 22.1, Section 18-200 et 18-274. Consultez la section appropriée et assurer la conformité avec l'une des options proposées.

Lors de la connexion à l'équipement USC depuis un emplacement distant et l'équipement USC est dans une classe dangereuse II, Groupe G environnement, les clients sont invités à suivre les exigences dans CSA 22.2 no. 25. Plus de détails peuvent également être trouvés dans 22,1 CSA 18-252 (Les méthodes de câblage). Il existe diverses options couvertes dans cette section pour le câblage dans une Classe II, Groupe G (poussière) environnement. Sélectionnez la meilleure méthode adaptée pour votre emplacement spécifique.

PLACEMENT & INSPECTION

The following steps outline the initial set-up of your Semi-Automated 4 Pump Controller:

1. Clear the area of bystanders, especially small children, before moving.
2. Be sure there is enough clearance from overhead obstructions and power lines or other equipment to move the machine into its working position.
3. Place the Semi-Automated 4 Pump Controller in the desired position on a level surface close to the pump stands it will be controlling.
4. Inspect the Semi-Automated 4 Pump Controller thoroughly for screws, bolts, fittings, etc. which may have come loose during shipping.

SEMI-AUTOMATED 4 PUMP CONTROLLER

NOTICE

USC highly recommends that the Semi-Automated 4 Pump Controller be set up inside a building or any covered structure to protect the machine from weathering.

AVIS

USC recommande fortement que le contrôleur 4 pompe semi-automatique être mis en place à l'intérieur d'un bâtiment ou d'une structure couverte pour protéger la machine contre les intempéries.

SETTING DC PUMP MOTORS

Each pump motor cable requires this plug (USC P/N 03-08-0324) which mates with a female plug (USC P/N 03-06-0087) on bottom of control panel. This panel only works with DC Motors. Pin configuration shown at bottom of page.

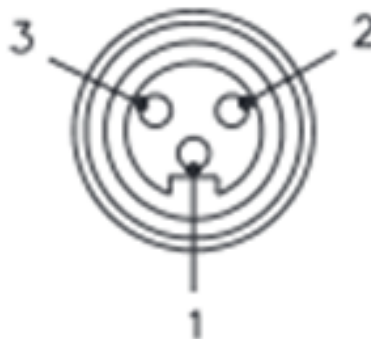

SETTING DC PUMP MOTORS

1. Line holes up so you can insert your small screwdriver into the part. Rotate the screwdriver side counter clockwise (while holding the black side) to separate.

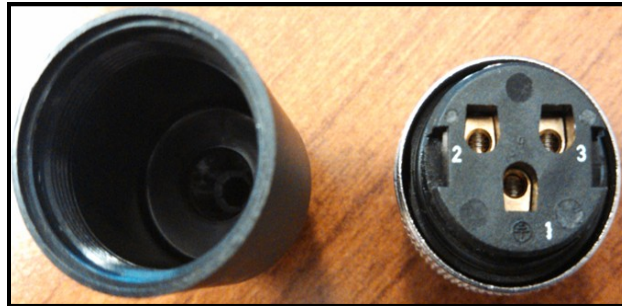

2. Strip the black insulation back 2.50 inches from the motor wires. Loosen the black nut, insert Motor wire as shown.



3. Wire motor leads into the correct terminations per your schematic. For USC pump motors, 1 = Ground, 2 = White, and 3 = Black.

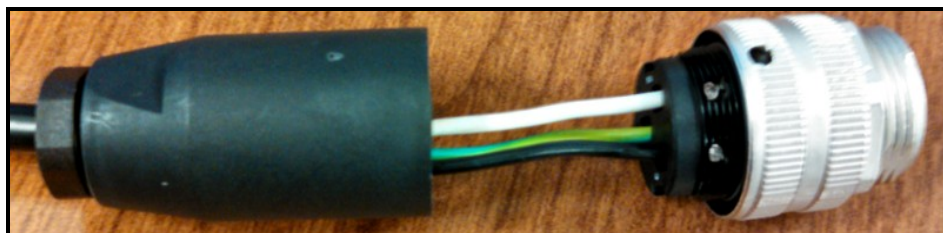

4. Line holes up so you can insert your small screwdriver into the part. Rotate the screwdriver side clockwise (while holding the black side) to reassemble. Tighten the black nut back down until the cord grip is tight on the insulation (page 18, top).

SETTING DC PUMP MOTORS



5. Connect the cable to one of the four mating connectors on the bottom of the control panel. Turn the power back on to the panel. Place the pump you just wired in HAND mode. Check the pump, if it is running forward you are ready to use your pump stand. If the motor is running backwards you will need to turn off power and swap the black and white wires. Place the pump back in HAND mode. If you are still having problems with your pump, please call 785-431-7900 and ask to speak with a service technician.

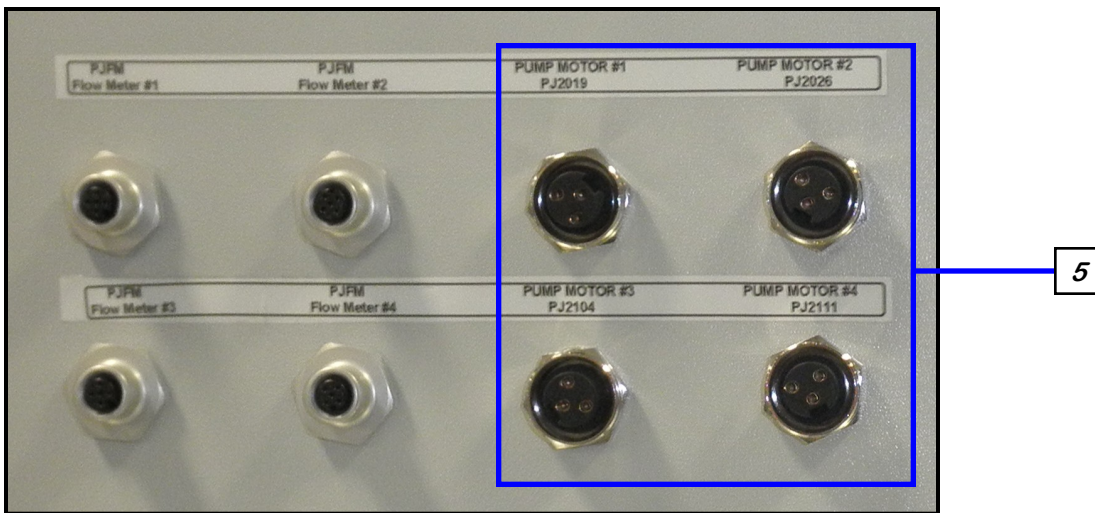

NOTICE

This program will work with Volumetric Flow Meters IFM SM6000 and SM6001, as well as Mass Flow Meter E&H 80E08. All three flow meters require a patch cable (03-08-0292) that will connect the Flow Meter to the control panel. The patch cable is included with USC pump stands or may be ordered separately.

AVIS

Ce programme travaillera avec compteurs volumétriques de débit IFM SM6000 et SM6001, ainsi que Débitmètre massique E & M 80E08. Tous les trois débitmètres nécessitent un câble de raccordement (03-08-0292) qui reliera le débitmètre au panneau de commande. Le câble de raccordement est inclus avec USC pieds de pompe ou peut être commandé séparément.

DC PUMP BOARD SETTINGS

For part numbers 03-01-0163 and 03-10-0164 (Signal Isolator and Regenerative Drive)

JUMPER SETTINGS

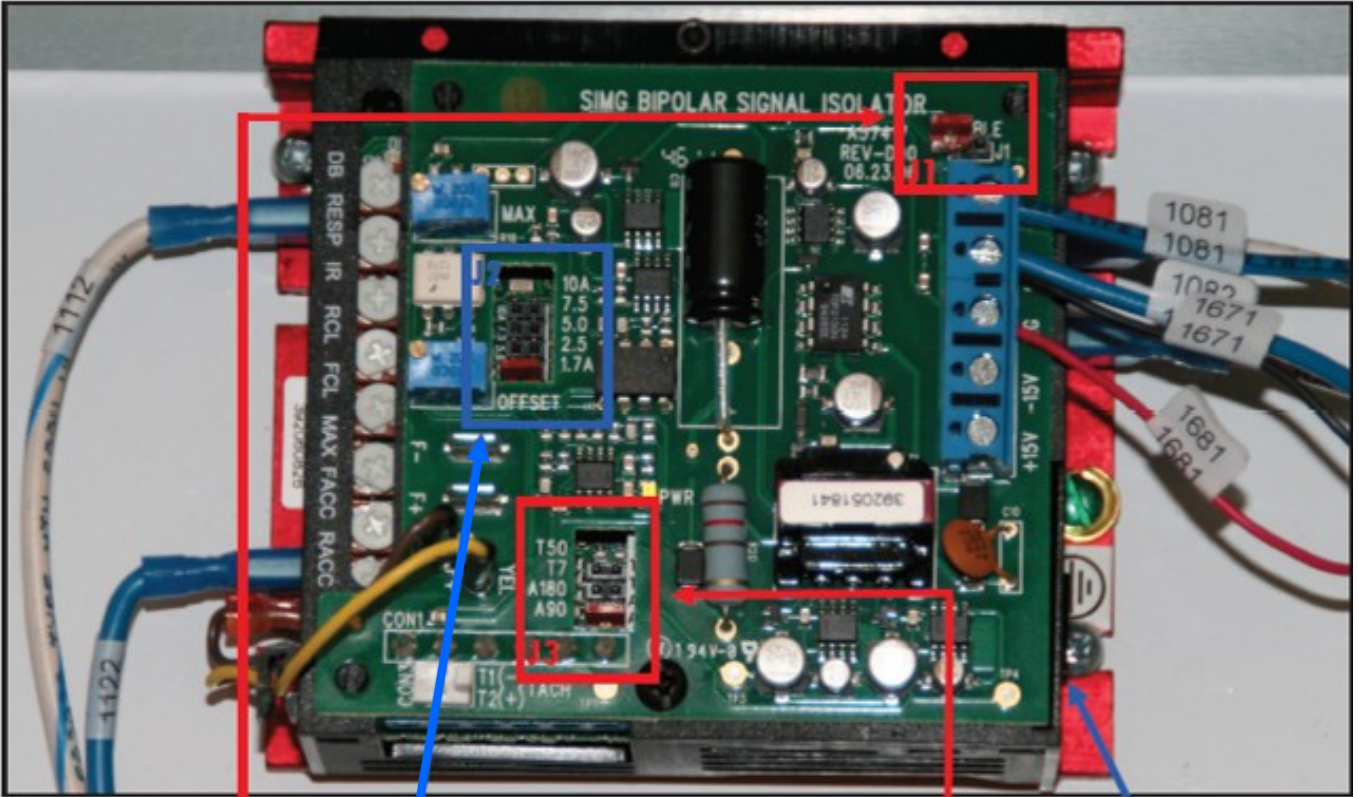

1. Remove jumper J1.
2. Set jumper J2 to 1.7A or 2.5A per schematic. (Sets Motor Current)
3. Set jumper J3 to A90. (Sets Motor Voltage)
4. Set jumper J1A and J1B to 115V. (Sets AC Line Voltage)



DC PUMP BOARD SETTINGS

For part numbers 03-01-0163 and 03-10-0164 (Signal Isolator and Regenerative Drive)

TRIM POT SETTINGS

Factory Settings for Trim Pots Shown.

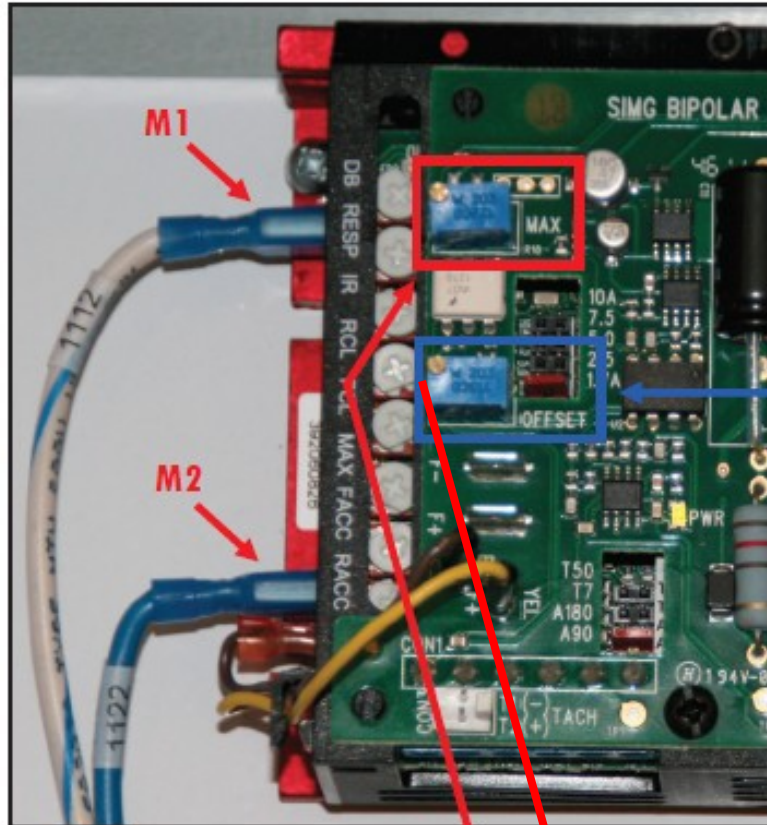

1. Ensure all trim pots are set to the factory settings.
2. Turn the FACC white trim pot counter clockwise as far as it can.
3. Turn the MAX white trim pot clockwise as far as it can.
4. On the HMI, set pump speed to 10% and place the red volt meter lead on M1 (white/blue wire) and the black lead on M2 (blue wire). Adjust the blue MAX trim pot until your volt meter reads -10 VDC. It is imperative that the volt meter is reading a negative voltage otherwise the pump will run in the wrong direction. Then set the pump speed to 50% and adjust the blue MAX trim pot until the meter reads -44.5 VDC. Finally, set the pump speed to 100% and adjust the blue MAX trim pot until the meter reads -89 VDC. Double check that the pump is rotating in the correct direction.
5. On the HMI, set the pump speed back to 5% and adjust the blue OFFSET trim pot until your volt meter reads -5 VDC. This will help to ensure that the pump does not flip directions during a run.

MECHANICAL OPERATION

SEMI-AUTOMATED 4 PUMP CONTROLLER OVERVIEW

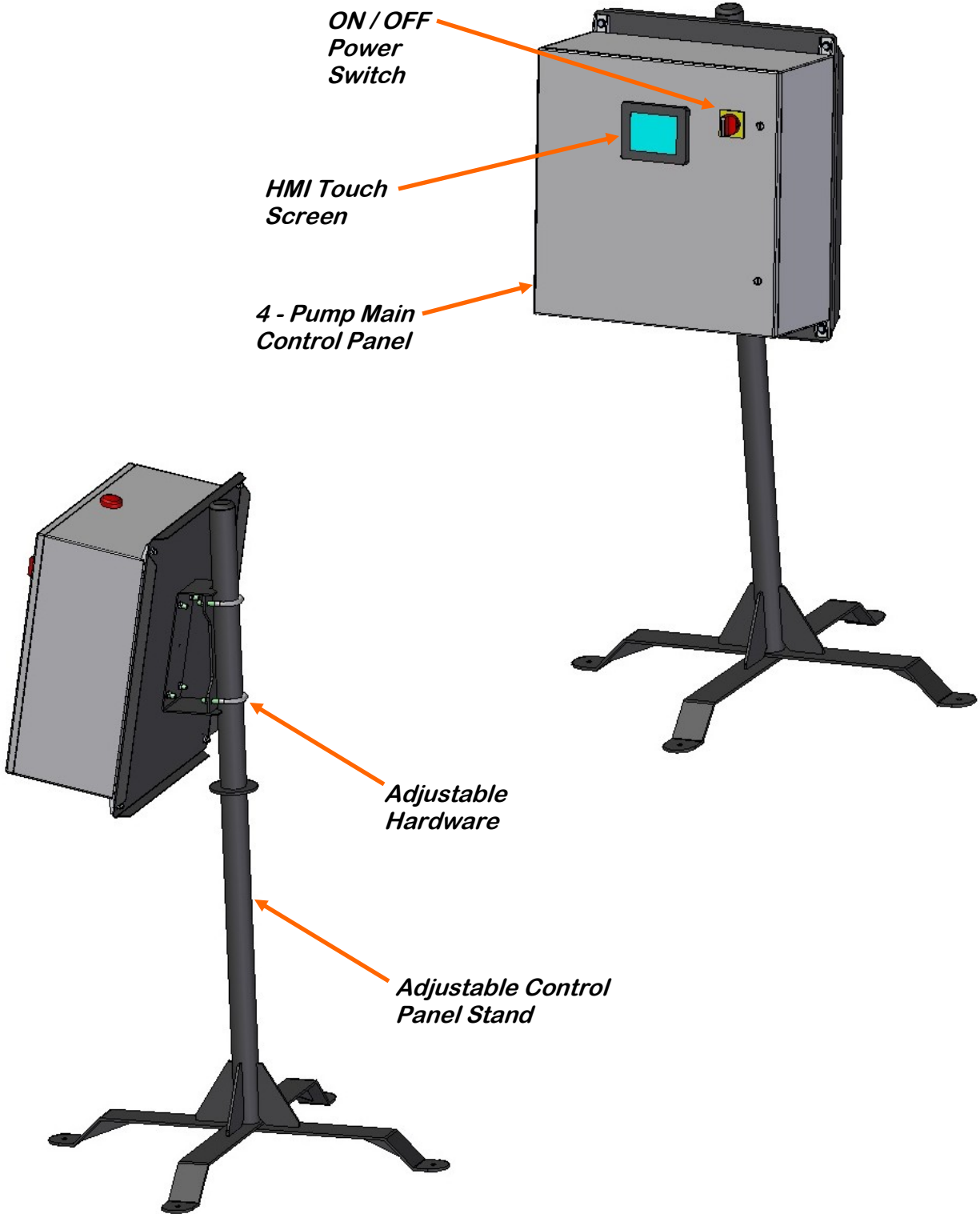

SECTION
D**ELECTRICAL OPERATION**

HIGH VOLTAGE ~ Always disconnect the power source before working on or near the control panel or lead wires.



HAUTE TENSION ~ Toujours débrancher la source d'alimentation avant de travailler sur ou près du panneau de commande ou les câbles.



HIGH VOLTAGE ~ Use insulated tools when making adjustments while the controls are under power.



HAUTE TENSION ~ Utilisez des outils isolés lors des réglages, tandis que les commandes sont sous tension.



AUTHORIZED PERSONNEL only shall work on the control panel. Never allow anyone who has not read and familiarized themselves with the owner's manual to open or work on the control panels.



Seules personnes autorisées doivent travailler sur le panneau de commande. Ne jamais laisser quelqu'un qui n'a pas lu et se sont familiarisés avec le manuel d'ouvrir ou de travail du propriétaire

This section provides a general overview and description of the operator controls for the Semi-Automated 4 Pump Controller. The system is configurable to operate with USC pump stands, Non-USC pump stands or a combination of the two. The Non-USC pump stands must have a DC pump motor.

USC recommends the use of a surge protection device with a minimum rating of 400 Joules for all automated main control panels.



USC recommande l'utilisation d'un dispositif de protection contre les surtensions avec une cote minimale de 400 joules pour tous les principaux panneaux de contrôle automatisés.



General Panel Descriptions

- The Semi-Automated 4 Pump Controller connects to and controls up to 4 individual pump stands. Each individual pump is plug connected to the control panel. The flow meters are plug connected. The panel contains the PLC (Programmable Logic Controller) as well as the HMI (Human Machine Interface) touch screen. The operator is able to control the entire system through the HMI. Power to this panel is supplied from a standard 110V plug.

The following pages explain the function of the touch screen controls.

USC START UP SCREEN

While the system is booting up, the touch screen will display a timer bar at the bottom of the Start Up Screen. Once the timer bar reaches the end it will disappear and be replaced with flashing piece of text that reads CLICK TO CONTINUE. Select any where on the screen and it will advance to the Main screen.

This screen also displays the version of the software currently installed.



SEMI-AUTOMATED 4 PUMP CONTROLLER

MAIN SCREEN

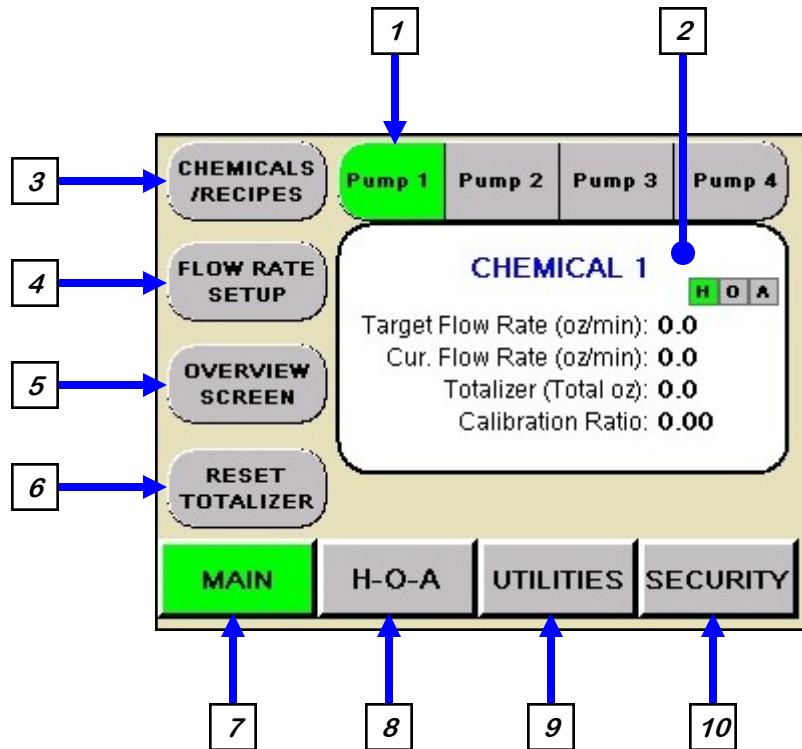

1. PUMP IDENTIFICATION: Displays which pump stand main screen the operator is in by highlighting it in green. It also allows the operator to move from one pump stand to another without returning to the Overview screen.

2. CHEMICAL STATUS BOX: Displays the name of the active chemical at the top, as well as the target flow rate and the current flow rate. The totalizer displays the amount of chemical used and the calibration ratio for the chemical being used. The H-O-A display in the upper right corner informs the operator of the current active motor status without having to press the H-O-A button and leaving the main screen

3. CHEMICALS / RECIPES: Pressing this button advances the operator to the Chemical / Recipes Selection or Editing pop up screen (see page 26).

4. FLOW RATE SETUP: Pressing this button advances the operator to the flow rate setup screens screen (see page 31).

MAIN SCREEN

5. OVERVIEW SCREEN: Pressing this button advances the operator to the Overview screen (see page 33).

6. RESET TOTALIZER: Pressing this button will reset the totalizer display after a run is complete.

7. MAIN: This button returns the operator to the Main screen from any other screen in the system.

8. H-O-A: This button advances the operator to the H-O-A screen (see page 34).

9. UTILITIES: This button advances the operator to the Utilities screen (see page 35).

10. SECURITY: This button advances the operator to the Security screen (see page 38).

NOTICE

Some of the screens have a round blue button with a question mark in the upper left corner of the screen. Selecting this button will bring up a help screen covering the functions of that screen.

CHEMICALS / RECIPE SELECTION AND EDITING SCREEN

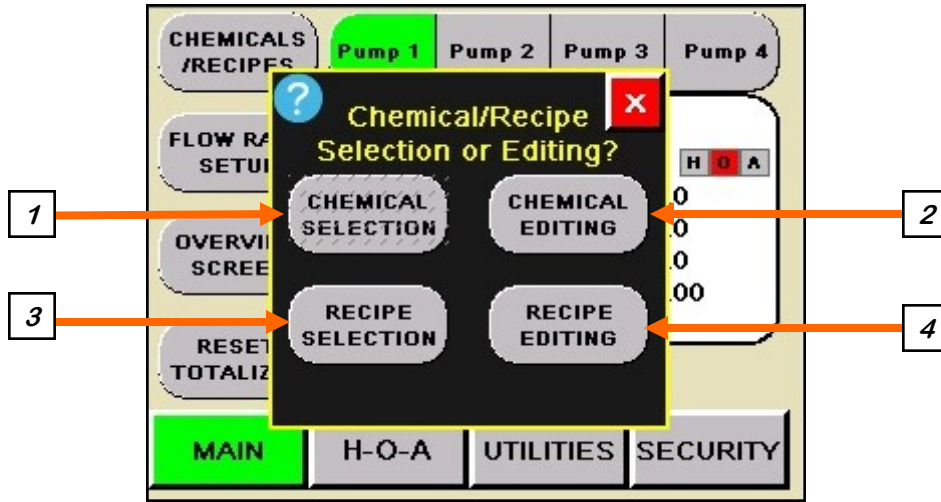

1. CHEMICAL SELECTION: Press this button and the Chemical Selection screen appears. (Bottom left) Use the arrows to scroll through the list to find the chemical you wish to use. The system can store up to 100 different chemical entries. Each chemical type will have its own name and calibration ratio. When operating in the Recipe mode, this button will become inactive because the recipe is now dictating the chemical selection.

2. CHEMICAL EDITING: Pressing this button advances the operator to the Chemical Editing screen (bottom, right). Select a chemical from the listing to modify or an unused box to create a new chemical entry. The Chemical Editing screen will appear (see page 28). This button is always active, even if operating in recipe viewing mode.

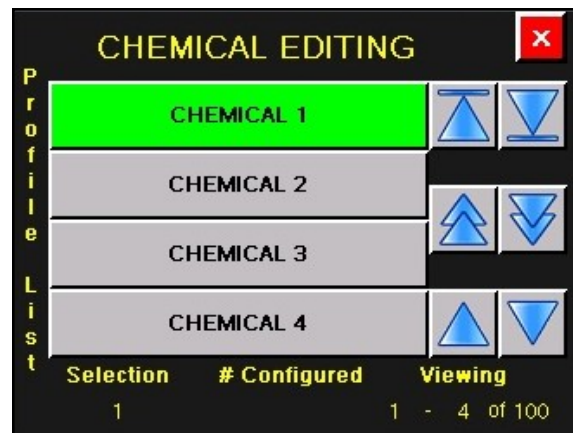
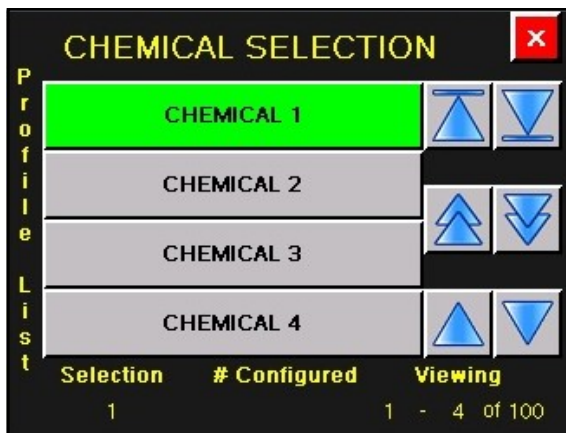

CHEMICALS / RECIPE SELECTION AND EDITING SCREEN

3. SELECT PUMP(S) RECIPE: Press this button and the Select Pumps Recipe screen appears (Bottom left). Using the up and down arrows the operator may scroll through the list of recipes and select it. Choosing a recipe will set all pumps to the preconfigured rates, based upon your Flow Rate Setup settings, for all pumps. The pumps will be set to AUTO or OFF based on the individual pump settings in the recipe. The system can store up to 20 recipes. The recipes will appear in the order they were created.

4. EDIT PUMP(S) RECIPE: Displays the same list as the select screen to allow the operator to find and edit the recipe (Bottom right). Select the name to modify and the Recipe Editing screen for that recipe appears (See page 30).

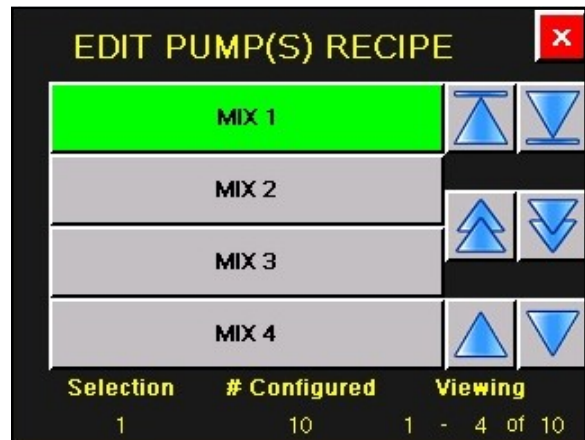
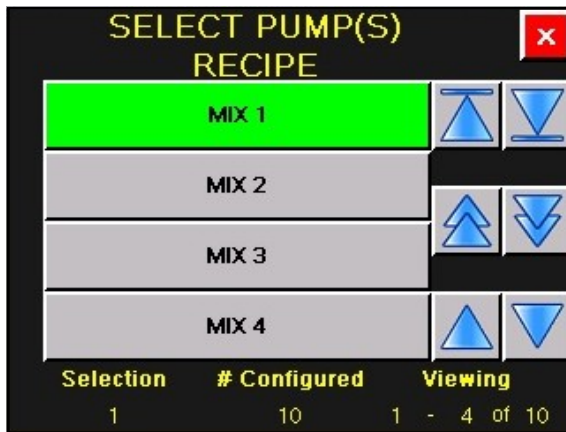

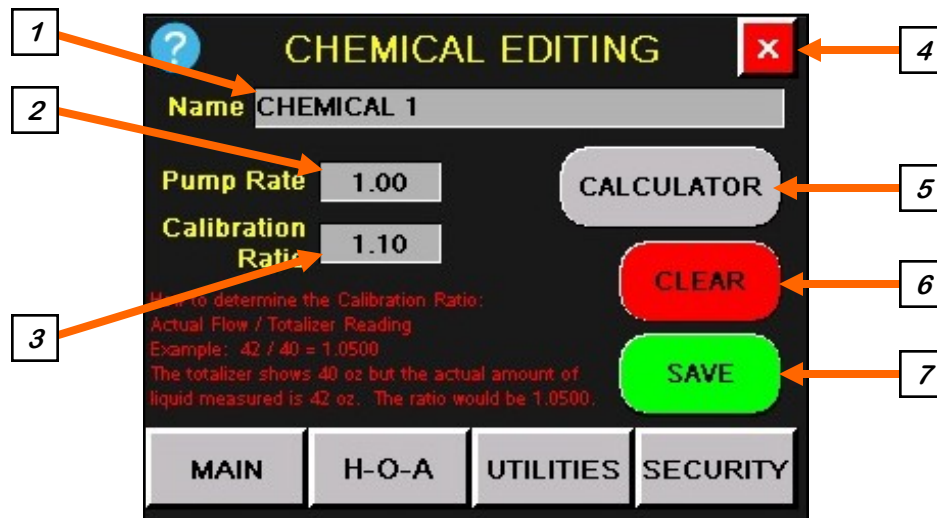
CHEMICAL EDITING SCREEN

1. CHEMICAL NAME: When this button is pushed an alpha numeric keypad appears allowing the operator to change an existing chemical name. If an unused box was selected from the list, the name will be blank and the Calibration Ratio will be 1.0. allowing the operator to enter a new chemical into the system. Once saved, it will be added to the list.

2. PUMP RATE: This button is only present when recipe mode is enabled. It is the pump rate that will be used when recipe mode is enabled. A flow rate setup screen should be interlocked and the recipe pump rates will be used instead.

3. CALIBRATION RATIO: When this button is pushed a numeric keypad appears allowing the operator to manually enter the multiplier used for flow meter calibration.

4. SCREEN EXIT: This button is used to return to the previous screen. It's functionality is the same throughout all of the HMI screens.

5. CALCULATOR: Pressing this button takes the operator to the Calibration Calculator screen (see page 29).

6. CLEAR: This button deletes the name and resets the Calibration Factor to 1.00. After a new name and calibration factor has been entered, press the save button. This is another way to enter a new chemical name in the system.

7. SAVE: Saves any changes to the chemical profile.

CALIBRATION CALCULATOR SCREEN

The screenshot shows the 'CALIBRATION CALCULATOR' screen. At the top left is a question mark icon, and at the top right is a red 'X' icon. Below the title, there is a field for 'SELECTED CHEMICAL' containing 'CHEMICAL 1'. The screen is divided into two columns: 'TOTALS' and 'CALIBRATION'. The 'TOTALS' column has three rows: 'Actual Ounces' with a value of 1.1, 'Target Ounces' with a value of 1.0, and 'Totalizer' with a value of 0.0. The 'CALIBRATION' column has two rows: 'Calculated Ratio' with a value of 1.1000 and 'Current Ratio' with a value of 1.0000. At the bottom, there are two buttons: a green 'APPLY' button and a red 'DEFAULT' button. Numbered callouts (1-9) point to these elements: 1 to Actual Ounces, 2 to Target Ounces, 3 to Totalizer, 4 to APPLY, 5 to the red X, 6 to CHEMICAL 1, 7 to Calculated Ratio, 8 to Current Ratio, and 9 to DEFAULT.

1. ACTUAL OUNCES: Pressing this button brings up a keypad used to enter the actual ounces applied during the calibration procedure (see page 41).

2. TARGET OUNCES: Pressing this button brings up a keypad used to enter the amount of ounces the system should have been applied.

3. TOTALIZER: This display indicates the amount of chemical the program estimates it applied on the last run.

4. APPLY: After the actual ounces and target ounces have been entered, the calculated ratio will be updated. Pressing this button returns the operator to the chemical editing screen and updates the calibration ratio.

5. SCREEN EXIT: Pressing this button returns the operator to the chemical editing screen.

6. SELECTED CHEMICAL: This display indicates the name of the chemical for this calibration.

7. CALCULATED RATIO: This display indicates the amount the current calibration will be adjusted when the apply button is pressed.

8. CURRENT RATIO: This display indicates the current calibration.

9. DEFAULT: Pressing this button returns all values to the default setting of one.

NOTICE

The actual ounces will always be the amount caught by either a calibration tube or other measuring device. The target ounces are the amount that should have been caught in the measuring device. The operator may use the amount they physically measured, or the totalizer amount. The totalizer amount is the programs estimation of what the measuring device should have received.

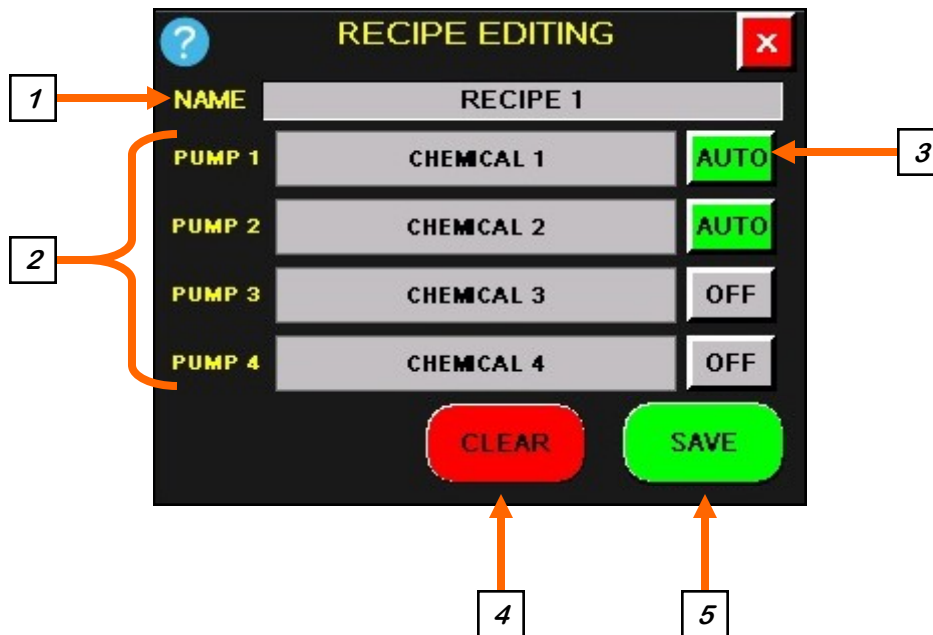
RECIPE EDITING SCREEN

1. RECIPE NAME: When this button is pushed an alpha numeric keypad appears allowing the operator to create or change the recipe name.

2. CHEMICAL SELECTION: Pressing this button returns the operator to the Chemical Selection editing screen.

3. PUMP MOTOR STATUS: This button toggles between AUTO to include the chemical in the recipe or OFF to exclude it.

4. CLEAR: This button deletes the recipe and chemical names . After a new name and chemicals have been entered, press the save button. This is another way to enter a new chemical name in the system.

5. SAVE: Saves any changes to the recipe profile.

SEMI-AUTOMATED 4 PUMP CONTROLLER

FLOW RATE SETUP SCREENS

This screen allows the operator to cycle through different modes of operation by pressing the MODE display box at the top left of the screen. The different modes are discussed below.

MODE: Off - Allows the operator to control the pump through the Utilities screen.

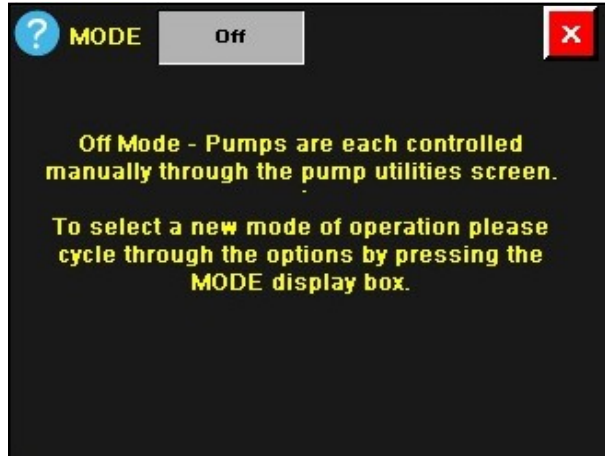

MODE: oz / SCU & SCU / min - Allows operator to enter the treater seed flow rate in SCU / min and the chemical application in oz / SCU for the pump. The system will convert it to oz / min and display it in the white box.

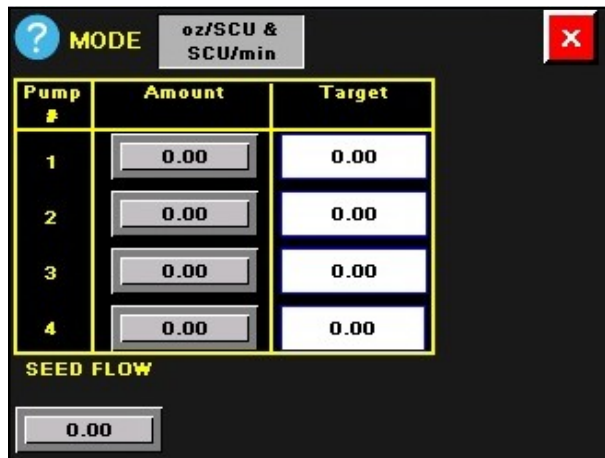

MODE: oz / SCU & lb / min - Allows the operator to enter the Seeds / Unit and Seed Count boxes as well as enter the treater seed flow in lb / min and the chemical application in oz / SCU. The system will convert it to oz / min and display it in the white box.

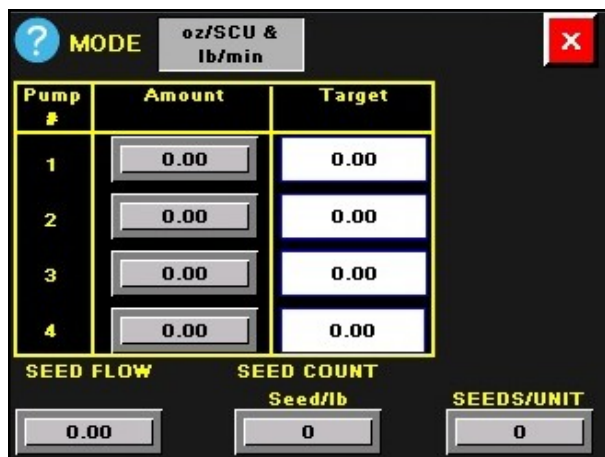

FLOW RATE SETUP SCREENS

MODE: oz / CWT & SCU / min - Allows the operator to enter the Seeds / Unit and Seed Count boxes as well as enter the treater seed flow in SCU / min and the chemical application in oz / CWT. The system will convert it to oz / min and display it in the white box.

Pump #	Amount	Target
1	0.00	0.00
2	0.00	0.00
3	0.00	0.00
4	0.00	0.00

SEED FLOW: 0.00 SEED COUNT Seed/lb: 0 SEEDS/UNIT: 0

MODE: oz / CWT & lbs / min – Allows the operator to enter the treater seed flow in lbs / min and the chemical application in oz / CWT. The system will convert it to oz / min and display it in the white box.

Pump #	Amount	Target
1	0.00	0.00
2	0.00	0.00
3	0.00	0.00
4	0.00	0.00

SEED FLOW: 0.00

MODE: Direct Translation – Allows the operator to set pump in oz / min. The rate the user enters will be the rate at which the pump will operate.

On the right side of this screen is the Current Batch Run Time(s) option. This will appear on all of the Flow Rate Setup screens if the Batch Mode button on the Tools & Options screen is active. This option is used when the pump stand is being used with a Batch Treater. It allows the operator to set a run time for each batch that starts when it receives the start signal from the treater and stops when the designated time has elapsed.

Pump #	Amount	Target	CURRENT BATCH RUN TIME (s)
1	0.00	0.00	0
2	0.00	0.00	0
3	0.00	0.00	0
4	0.00	0.00	0

OVERVIEW SCREEN

This screen displays the basic information for each of the four pump stands being controlled by the Universal Semi-Automated 4 Pump Controller simultaneously.

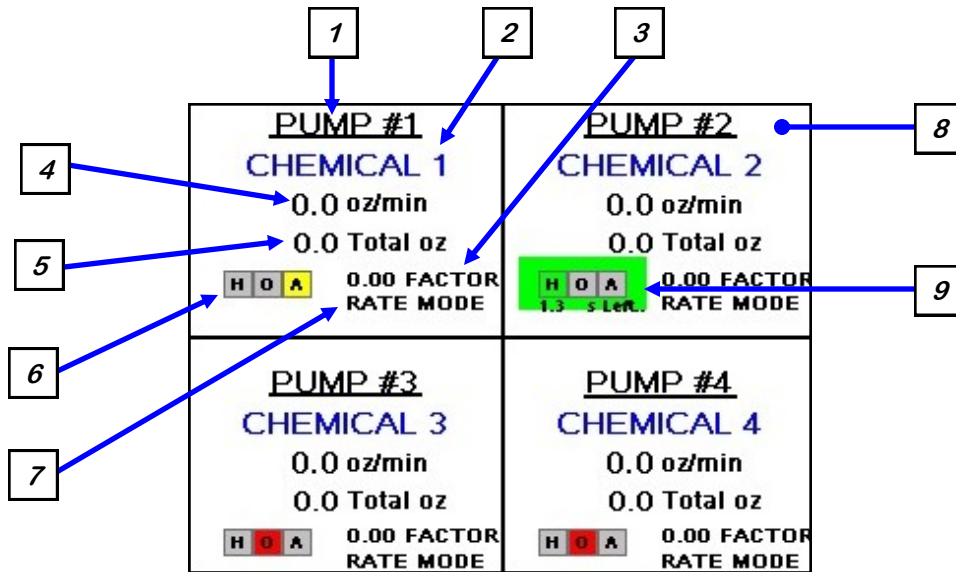

1. PUMP IDENTIFICATION: Displays the number of each individual pump controlled by the system.

2. CHEMICAL NAME: Displays the name of the chemical currently assigned to each individual pump.

3. FACTOR: Displays the Calibration Ratio (see page 29).

4. OUNCES PER MINUTE: Displays the ounces of chemical per minute being applied. It also may be displayed in milliliters.

5. TOTAL OUNCES: Displays in real time the amount of chemical that has been applied.

6. H-O-A: Displays what mode the pump is in, HAND, OFF or AUTO (see page 34).

7. SPEED CONTROL: The system is able to operate in two different speed control modes. Flow Rate Mode makes the pump drive to and then lock onto a desired flow rate. Percentage Mode makes the pump run at pre-defined percentage of the maximum motor speed.

8. MAIN SCREEN BUTTON: Press any of the four boxes and the operator will be taken to the main screen (see page 24).

9. PUMP MOTOR RUNNING INDICATOR: When the green box is present, it indicates that the motor is running. When the green box is flashing on and off, the motor is running in reverse. If operating in Batch mode, a timer indicating how much time is left for the batch will appear in the green indicator below the HOA block.

SEMI-AUTOMATED 4 PUMP CONTROLLER

H-O-A SCREEN

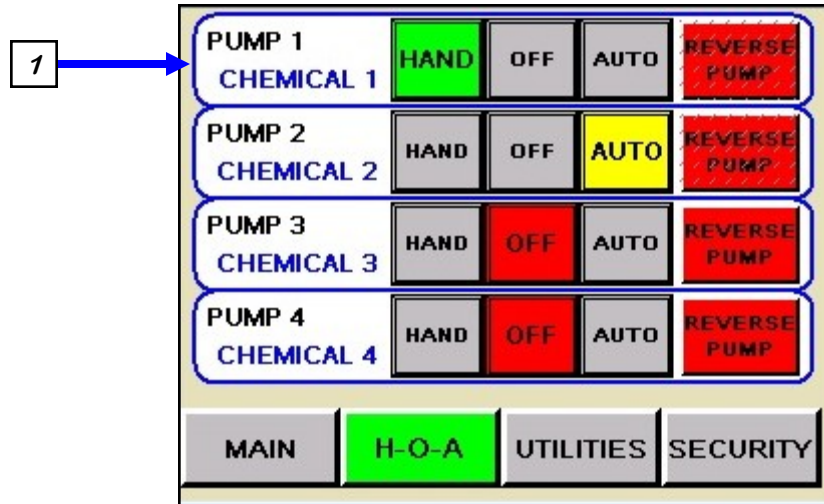

1. PUMP H-O-A MODULE: This module controls the function of the pump motors. The HAND button will place the pump motor on in the manual mode of operation. When it is active it will turn green. The OFF button will turn the motor off in the manual mode of operation. When it is active it will turn red. The AUTO button will place the device in the automatic mode of operation. When it is active it will turn yellow. This button is used when the pump stand is attached to a seed treater. This allows the treater to turn the pump on and off at the appropriate time. Pressing the REVERSE PUMP button will place the pump in HAND mode but the pump will be running backwards.

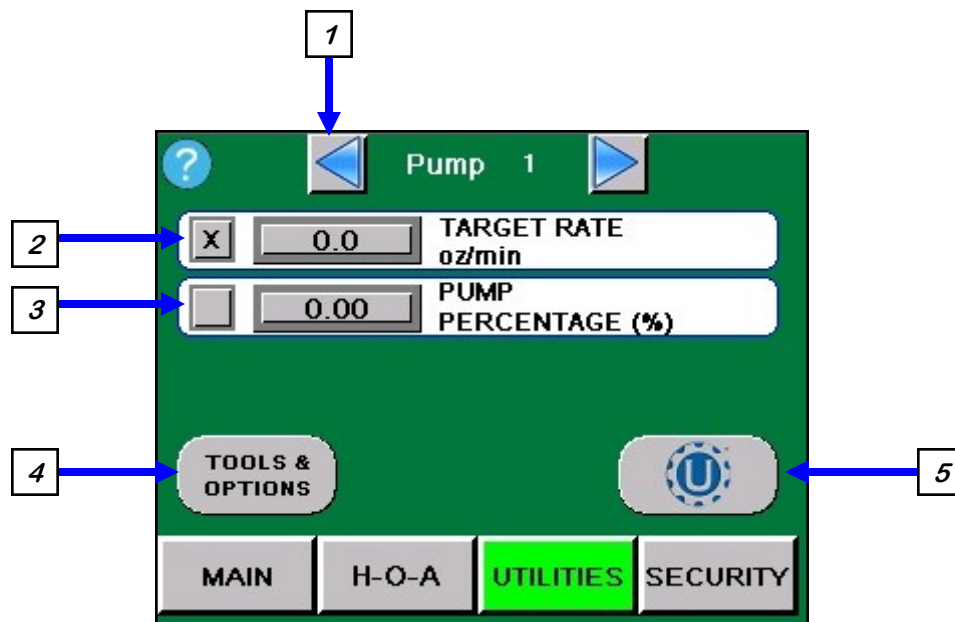
UTILITIES SCREEN

1. ARROWS: Selecting the arrow buttons allows the operator to scroll through all of the pumps to set up each one individually.

2. TARGET RATE: When this button is pushed a numeric keypad will appear on the screen. This allows the operator to set an application target rate in ounces or milliliters per minute. This option is unavailable while Flow Rate Mode is on any setting other than OFF.

3. PUMP PERCENTAGE RATE: When this button is pushed a numeric keypad will appear on the screen, enter a percentage value. This method disregards the flow meter reading. It drives the pump to a specified percentage of the maximum pump speed.

4. TOOLS & OPTIONS: Pressing this button takes the operator to the Tools & Options screen (see page 36).

5. START-UP SCREEN: This button returns the operator to the starter screen (see page 23).

TOOLS & OPTIONS SCREEN

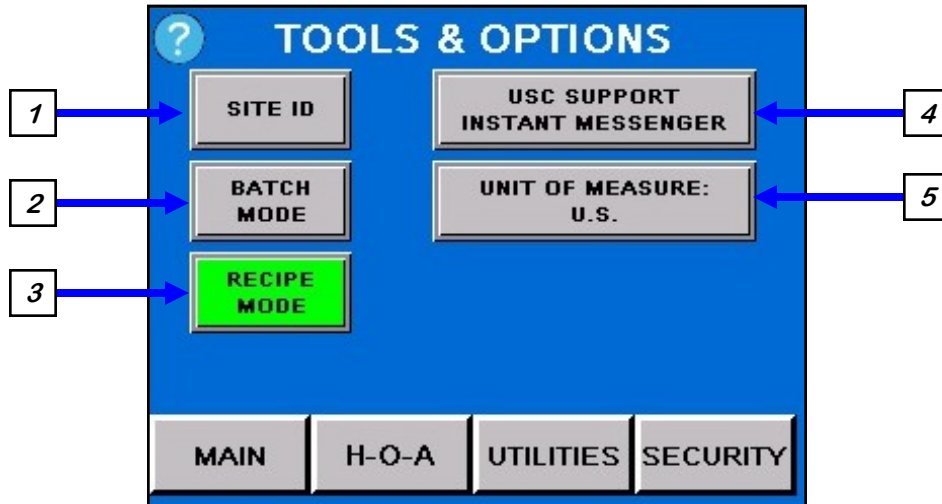

1. SITE ID: Pressing this button brings up the Site Identification screen. Press the Site Name field and an alpha numeric keyboard will appear for entering the name of the installation. The Site Description is automatically populated with the description of the current software loaded. This information will be used by USC service personnel to verify the customers installation.



2. BATCH MODE: Pressing this button activates Batch Mode. When active it will turn green. This option is used when the pump stand is attached to a batch treater. The start signal will be sent from the treater and the pump will start. It will run for the amount of time pre-set on the Flow Rate Setup screen. See bottom of page 32.

TOOLS & OPTIONS SCREEN

3. RECIPE MODE: Pressing this button activates Recipe Mode. When active it will turn green. This option is used when the operator wishes to use a combination of chemicals defined in the recipe module instead of choosing an individual chemical (see page 26).

4. USC INSTANT MESSENGER: Pressing this button will advance the operator to the Instant Messenger screen. This is used by the technical support staff when a customer calls with a problem. The service technician uses this to remotely connect to the site and verify the site identification information. This connection can only be made by USC. Once the link has been established, it may be used to text information to and from the customer site. This option only functions if the operator has U-Connect light installed on their laptop or U-Connect Pro is connected to the control panel using a Thin Client to make the connection.

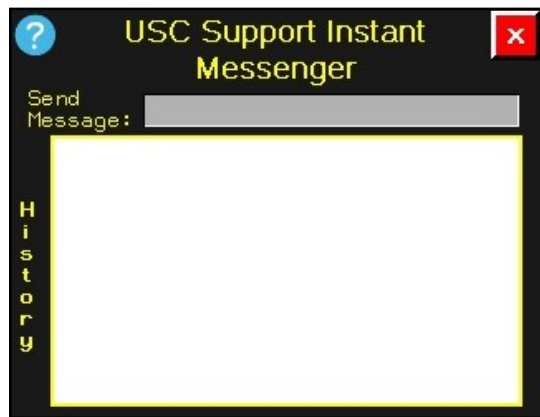

5. UNIT OF MEASURE: Pressing this button allows the operator to toggle between US or Metric units of measurement.

SECURITY SCREEN

1. PASSWORD ENTRY: The operator uses this input to obtain access to the Setpoints screen. When this button is pressed an alpha numeric keypad will appear. The password is **USC** and should only be made accessible to personnel qualified to operate the system.

2. LOGIN: Pressing this button **after** the password has been entered will activate the SETPOINTS button.

3. LOGOUT: Pressing this button will de-activate the Setpoint button.

4. SETPOINTS: Pressing this button advances the operator to the Setpoints screen (see page 39).

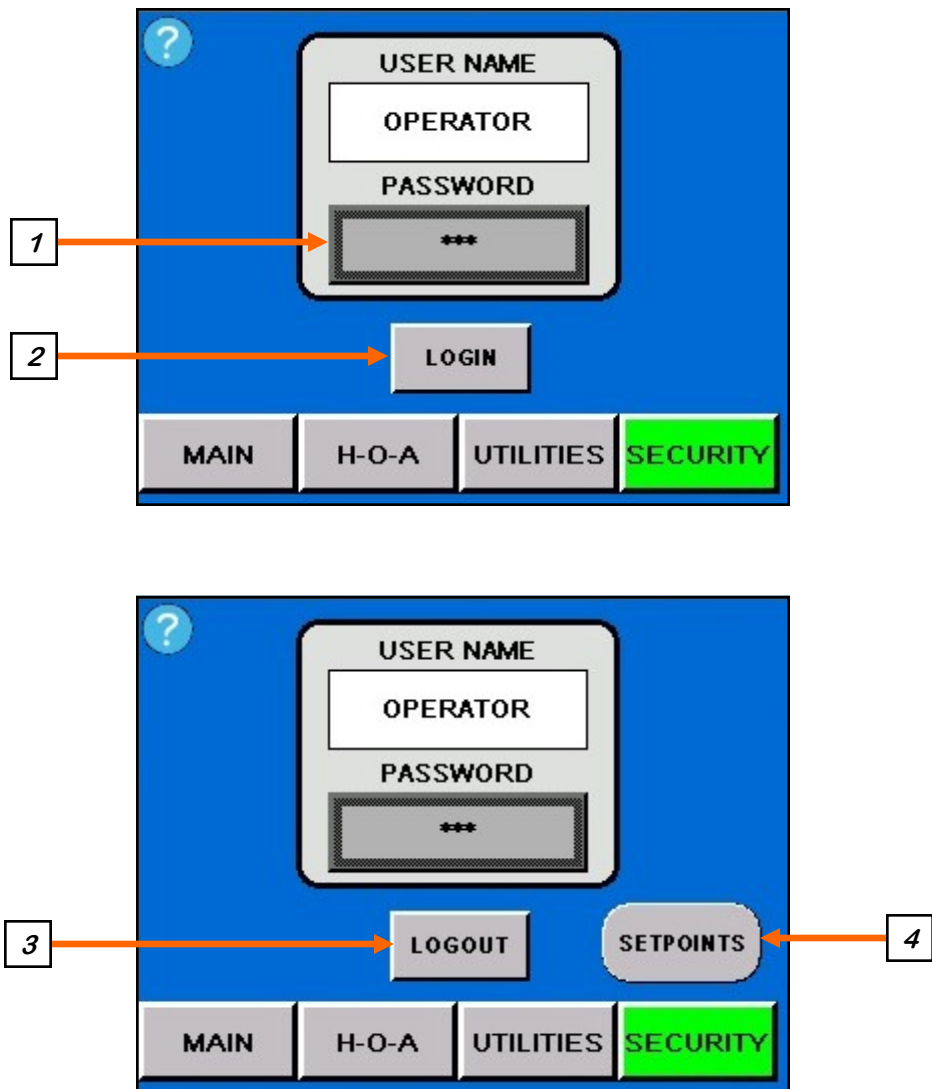

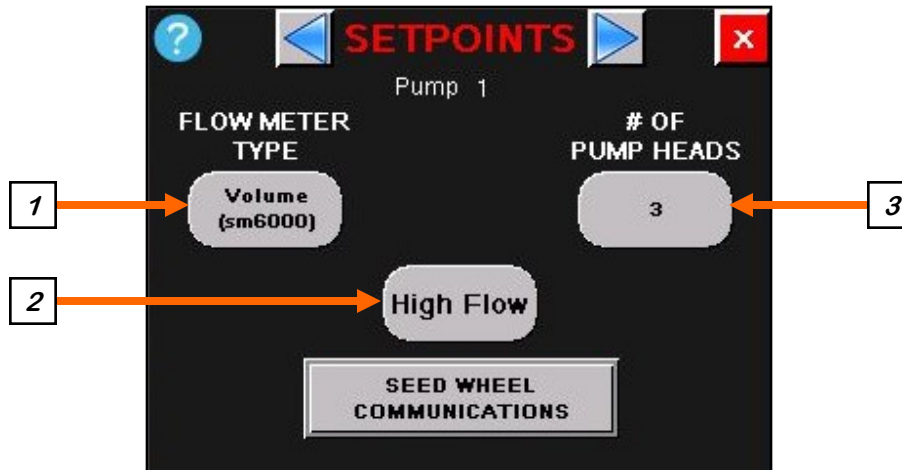
SETPOINTS SCREEN

1. FLOW METER TYPE: Pressing this button toggles between Volumetric, Mass, Low Flow and the Custom flow meter options to match the type of flow meter being used with your equipment. If using a Non-USC type pump, it would be set to custom activating the Custom PID Settings button (see page 40).

2. PUMP FLOW BUTTON: Pressing this button toggles between Low Flow, Base Flow and High Flow. The low flow setting is configured for the low flow peristaltic pump assembly. The base setting is configured for one of the three standard pump configurations. When set to base flow, the # of pumps heads button must be set to either 1, 2 or 3 to match the number standard peristaltic pump heads installed. The high flow setting is configured for the high flow peristaltic pump assembly.

3. # OF PUMP HEADS: Pressing this button toggles between 0, 1, 2 and 3 to be set to the number of peristaltic pump heads are on the pump stand.

SETPOINTS SCREEN

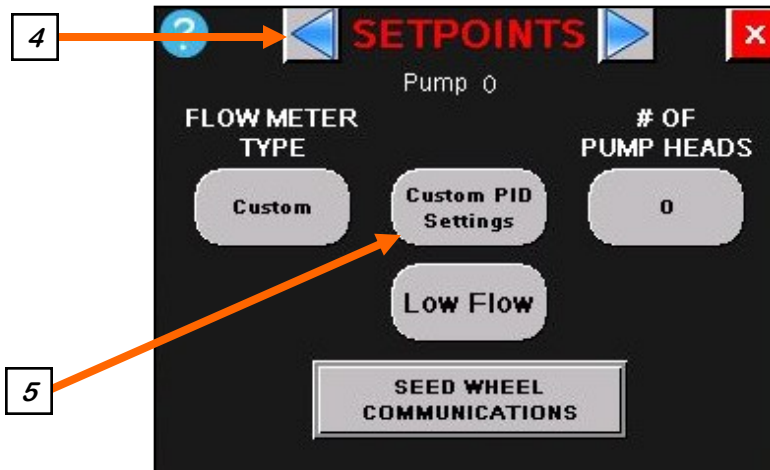

4. ARROWS: Selecting the arrow buttons allows the operator to scroll through all of the pumps to setup each one individually.

5. CUSTOM PID SETTINGS: Pressing this button advances the operator to the Custom PID Settings screen. If the flow meter type is set to Custom, the PID settings may need to be set on this screen. This screen allows the operator to manually enter custom PID settings for single or multiple head pumps. The system default settings are shown below. This screen is only used when non-USC pumps are being used and even then it may not be necessary to make any changes. If the operator has made changes and wants to return to the default settings, they may change the entry in the first row and the first column to zero, select the red X to exit the screen. This resets the screen to the default settings.

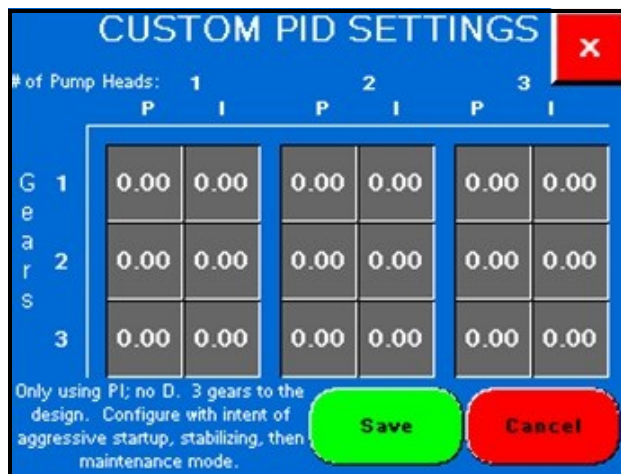

CALIBRATION

SECTION E

INITIAL PUMP CALIBRATION (USC Pump Stands)

1. Lock down the pump tubing in the pump head.
2. Premix enough liquid for the amount of seed you are treating and pour into the chemical mix tank. It's always a good practice to mix up 20% extra slurry to help fill all the lines.
3. From the Main screen press the Chemical button, then Chemical Editing. From the Chemical Editing screen, choose the type of chemical. From that screen, verify that the Calibration Factor is set to one. From the Utilities screen, enter the number of ounces needed per minute per hundred pounds of seed as the Target Rate
4. Set the return valves to Mix Tank for recirculation. Turn the ON / OFF switch for the mix tank motor to the ON position. Run it for 15 minutes to ensure that the chemical mixture within the mix tank is blended completely and any air is removed from the system.

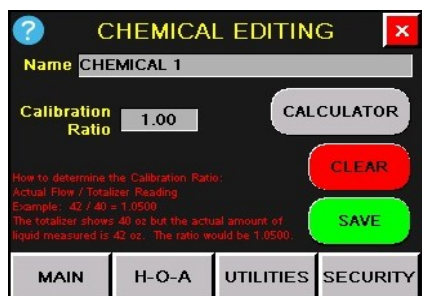
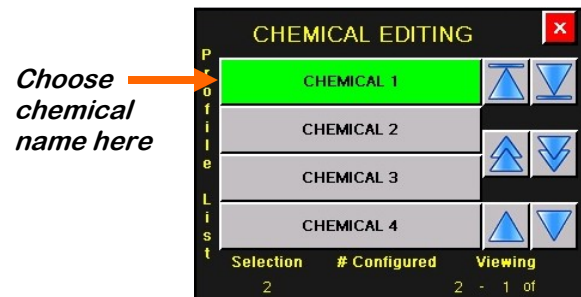
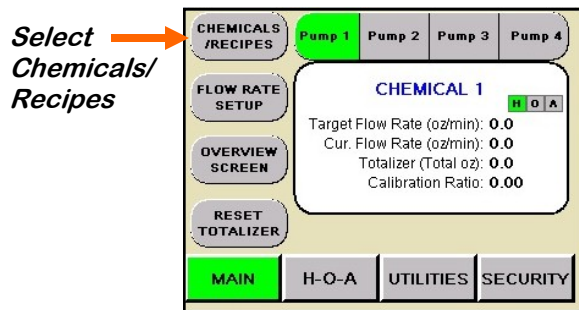

Enter Ounces per Minute

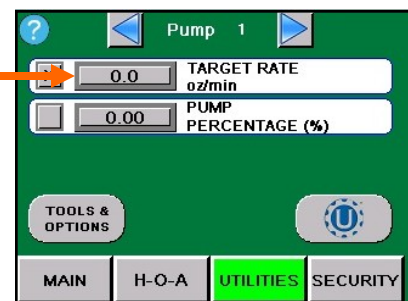

FLOW METER CALIBRATION (USC Pump Stands)

Due to the composition of some types of chemicals, additional flow meter calibration may be required. It is recommended that, like other calibration devices, the flow meter(s) are checked regularly and calibrated when needed. When calibrating the flow meter(s), each chemical slurry must be checked and adjusted for.

1. To begin the calibration process, fill the appropriate mix tank with the slurry that is going to be used for this calibration.
2. Turn the ON / OFF switch for the mix tank motor to the ON position. From the Utilities screen, enter a value for the Pump Percentage speed (Example 20) and check the box to the left. From the HOA screen, press the HAND button and ensure that the valves are set to Mix Tank for recirculation. Let the system run in recirculation mode for 15 minutes. This will remove any air from the system.
3. Press the Chemical button on the Main screen and select the correct chemical name.
4. Place the bottom return valve to MIX TANK / CALIBRATION TUBE. The valve is located on top of the pump stand (right). Place the top valve to the CALIBRATION TUBE position. Once the liquid in the Calibration Tube reaches zero press HAND or OFF to stop the pump. Press the Reset Totalizer button to zero out the Totalizer. Press the HAND button and start the stopwatch simultaneously. Stop the pump when the stopwatch reaches one minute. Note the total ounces of chemical that is in the calibration tube.
5. From the Calibration Calculator screen, enter the number of the ounces in the Actual Ounces box. Press the Apply button, then press Save. The system automatically calculates and places the amount in the Calibration Ratio box.
6. Repeat the process as necessary and for each different chemical slurry used.

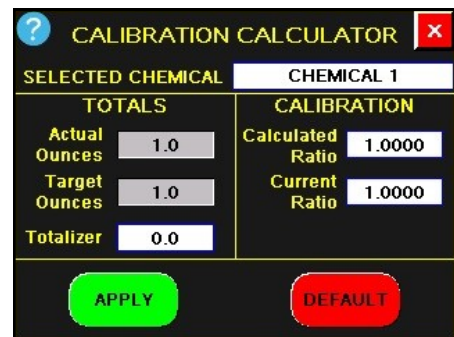
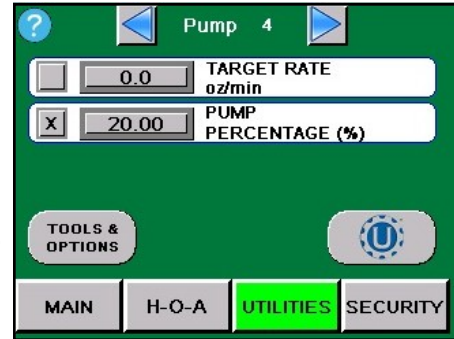

TROUBLESHOOTING**SECTION
F****TROUBLESHOOTING**

Below is a table describing the most frequent problems and solutions with the USC Semi-Automated 4 Pump Controller. For further assistance, contact the USC Service department at (785) 431-7900.

Problem	Possible Cause	Solution
Pump is fluctuating.	<ol style="list-style-type: none"> 1. Restriction in tubing 2. Filter is plugged or missing gasket. 3. Hoses are worn out. 	<ol style="list-style-type: none"> 1. Flush tubing and check filter for any restrictions. 2. Clean filter and check for gasket. 3. Replace hoses.
Pump will not turn off in AUTO when seed runs out. (USC Seed Treater)	<ol style="list-style-type: none"> 1. Proximity switch in the hopper cone is dirty. 2. Proximity switch is set too sensitive. 	<ol style="list-style-type: none"> 1. Clean proximity switch. 2. Adjust the pump proximity switch sensitivity by turning adjustment screw counter-clockwise.
Pump will not turn off in AUTO when seed runs out. (Non-USC Seed Treater)	<ol style="list-style-type: none"> 1. Signal to shut the pump off is not being sent from the treater. 	<ol style="list-style-type: none"> 1. Check treater control panel to see if signal is being sent to pump controller.
Pump will not turn on in AUTO. (USC Seed Treater)	<ol style="list-style-type: none"> 1. Proximity switch in the hopper cone is not staying covered. 2. Proximity switch is not sensitive enough. 3. HMI screen not set to AUTO. 4. Auxiliary cable not hooked up. 	<ol style="list-style-type: none"> 1. Make sure proximity switch is staying covered with seed. 2. Adjust pump proximity switch sensitivity by turning the adjustment screw clockwise. 3. Set HMI screen to AUTO. 4. Attach Auxiliary cable from control box to treater control box.
Pump will not turn on in AUTO. (Non-USC Seed Treater)	<ol style="list-style-type: none"> 1. Two pin cable is not connected to the pump control panel or the seed treater. 2. Signal to shut the pump off is not being sent from the treater. 3. HMI screen not set to AUTO. 	<ol style="list-style-type: none"> 1. Check to see that both ends of the cable are properly connected to their respective control panels. 2. Check treater control panel to see if signal is being sent to pump controller. 3. HMI screen not set to AUTO.
Mix Motor will not start	<ol style="list-style-type: none"> 1. Power cord not plugged in. 	<ol style="list-style-type: none"> 1. Plug in power cord.

SECTION
G**MAINTENANCE**

Proper maintenance of the Semi-Automated 4 Pump Controller is critical for peak performance, reliability and accuracy of this system. The following is a guideline for the type of maintenance and servicing that should be performed on this unit. Your environment and uses may require additional maintenance and service beyond this list to assure a reliable and safe unit. The operator of this unit has ultimate responsibility to identify areas of concern and rectify them before they become a hazard or safety issue. There is no substitute for a trained, alert operator.



Do not put this unit into operation with any questionably maintained parts. Poor performance or a hazard may occur.



Ne pas mettre cet appareil en service avec des pièces douteuse entretenus. La mauvaise performance ou un danger peut survenir.



Do not use compressed air or water under pressure to clean any of the components of the USC equipment.



Ne pas utiliser d'air comprimé ou de l'eau sous pression pour nettoyer l'un des composants de l'équipement USC.

ELECTRICAL PANEL

- Check and tighten wire connections.
- Check quick connects on bottom of control panel.
- Check to see if starters and/or overloads are tripped.
- Check to see if relays, timers and/or breakers are tripped.
- Check quick connects on end of Auxiliary cord.
- Check and tighten wire connections.
- Check relay and fuse holder.
- Check power cords for cuts or frays and ensure ground is present.

MIX TANK

- Check motor.
 - Check motor for any play in the mix tank shaft.
 - Check valves, fittings, and plug on bottom of tank for leaks.
 - Check chemical line tubing for abnormal wear.
 - Wipe down the motor casing with a damp cloth making sure to remove all dust that may have collected since the last maintenance date. Record the cleaning on the company required documents. If operating in a CSA 22.1, Class II, Division 2, Group G hazardous area, USC recommends this step be performed on a daily basis.
 - Essuyez le carter moteur avec un chiffon humide en veillant à éliminer toutes les poussières qui peuvent avoir perçu depuis la dernière date de maintenance. Enregistrez le nettoyage sur la société les documents requis. Si opérant dans un CSA 22.1, Classe II, Division 2, Groupe G zone dangereuse, USC recommande cette étape être effectuée sur une base quotidienne.
-

PUMPS - PLUMBING - FLOW METER

1. Check pump in forward and reverse.
2. Make sure pump heads open and close smoothly.
3. Inspect tubing for uneven wear. Replace pump tubing often to ensure high flow rates can be achieved.
4. Make certain the inside of the mix tank is completely drained of chemical residue.
5. Pump clean water through all areas of the plumbing including the mix tank, valves, and flow meter.
6. Remove and clean the filter.
7. Open all drain points, valves, and filter to let as much of the water drain as possible.
8. Disconnect power to the flow meter.
9. If your pump stand is equipped with a volumetric flow meter, remove it from the machine for additional cleaning.

PUMPS - PLUMBING - FLOW METER

9. A. Pre - Mix a solution of 90% water and 10% distilled white vinegar.

NOTICE

Only use the vinegar and water solution mixed in these proportions to clean the flow meter. Use of any other cleaners, especially cleaners containing harsh chemicals may permanently damage the sensors and seals inside the flow meter.

AVIS

Utilisez uniquement la solution de vinaigre et d'eau mélangés dans ces proportions pour nettoyer le débitmètre. L'utilisation d'autres produits de nettoyage, en particulier les produits nettoyants contenant des produits chimiques agressifs peuvent endommager de façon permanente les capteurs et les phoques à l'intérieur du débitmètre.

- B. Use a size - matched circular brush with soft plastic bristles. Dip the brush in the solution and gently move it up and down in the measuring pipe to avoid damaging the measuring pipe and sensor electrodes.
- C. Re-peat brushing with fresh fluid until measuring pipe is visually clean.
- D. Flush the flow meter inside and out with clean water to remove any of the cleaning solution residue.



- Wipe down the motor casing with a damp cloth making sure to remove all dust that may have collected since the last maintenance date. Record the cleaning on the company required documents. If operating in a CSA 22.1, Class II, Division 2, Group G hazardous area, USC recommends this step be performed on a daily basis.
- Essuyez le carter moteur avec un chiffon humide en veillant à éliminer toutes les poussières qui peuvent avoir perçu depuis la dernière date de maintenance. Enregistrez le nettoyage sur la société les documents requis. Si opérant dans un CSA 22.1, Classe II, Division 2, Groupe G zone dangereuse, USC recommande cette étape être effectuée sur une base quotidienne.

When storing the Semi-Automated 4 Pump Controller for long periods of time, the following procedure must be followed to reduce the chance of rust, corrosion and fatigue of the pump stand. You can also use these steps when storing the machine for the winter.



A dust mask and protective rubber gloves shall be used when cleaning the machine.

LIQUID SYSTEM (USC Pump Stands)

1. Make certain the inside of the tank is completely drained of chemical residue and thoroughly flush the inside of the tank with clean water.
2. Remove and clean the filter.
3. Pump clean water through all areas of the plumbing including the mix tank, flow meter, and valves. It may be necessary to move the position of the source valve and return valve from one position to another in order to clean all chemical lines including those that run to the seed treater.
4. Open all drain points, valves, and filter to let as much of the liquid drain as possible.
5. If the pump stand will be exposed to possible freezing temperatures, the final flush of the system should be made with a non freezable liquid. Or use compressed air to blow the lines out from any moisture.
6. Release pump heads and remove tubing to prevent any unnecessary wear .
7. Remove the flow meter from the pump stand and store in a location with the following conditions:
 - A. Ambient temperature of 50 to 80 degrees Fahrenheit.
 - B. Protection from direct sunlight to avoid unacceptable high surface temperatures.
 - C. Where moisture does not collect in or on the flow meter. This will help prevent fungus or bacteria infestation which can damage the liner.
 - D. Cover all openings.
 - E. Store in a manner so that the inlet and outlet are as much in an up and down position as possible.

SECTION
I

MECHANICAL DRAWINGS

ADJUSTABLE STAND - 4 - PUMP CONTROL PANEL (05-03-1471)

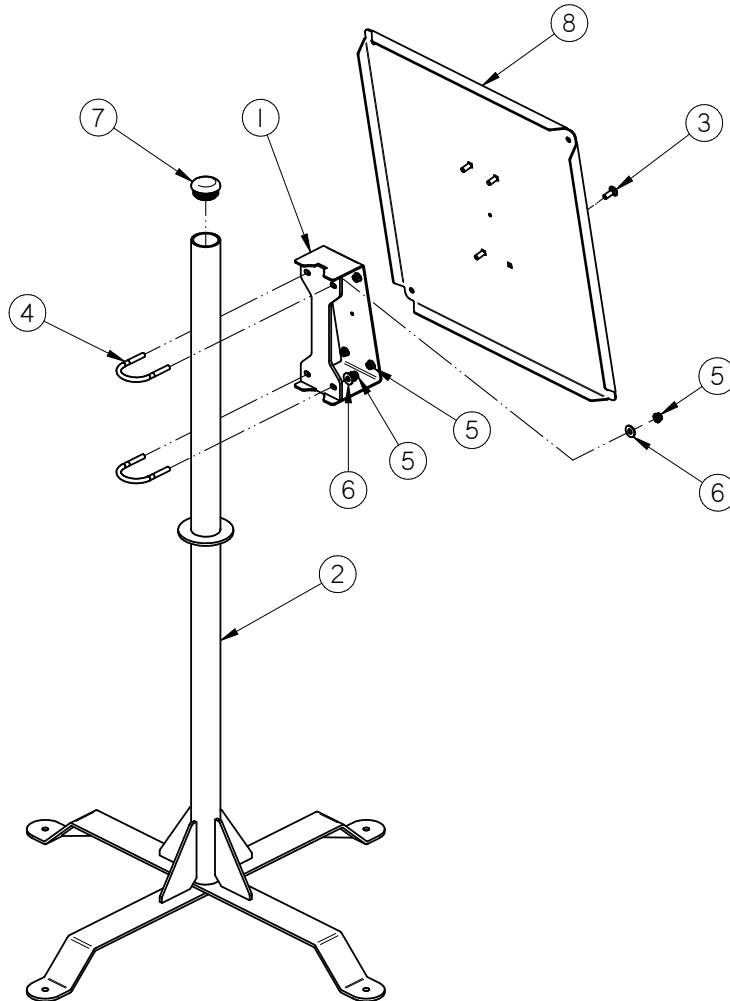

Item #	Part #	Description	Qty
1	05-03-1479	WDMT PNL ADJ	1
2	05-03-1545	WDMT PANEL STAND	1
3	06-01-0115	BOLT CRG .375-16 X 1.00 ZP GR5	4
4	06-01-0287	BOLT U .375-16 X 2.50 X 3.125 ZP	2
5	06-03-0014	NUT LOCK FLG .375-16 ZP GR5	8
6	06-05-0004	WSHR FLAT .375 ZP	4
7	06-10-0056	PLUG TBG RD RIB POLY 2.38 X .156W	1
8	103651	PLT PNL MT	1

SEMI-AUTOMATED 4 PUMP CONTROLLER

4 - PUMP CONTROL PANEL ASSEMBLY

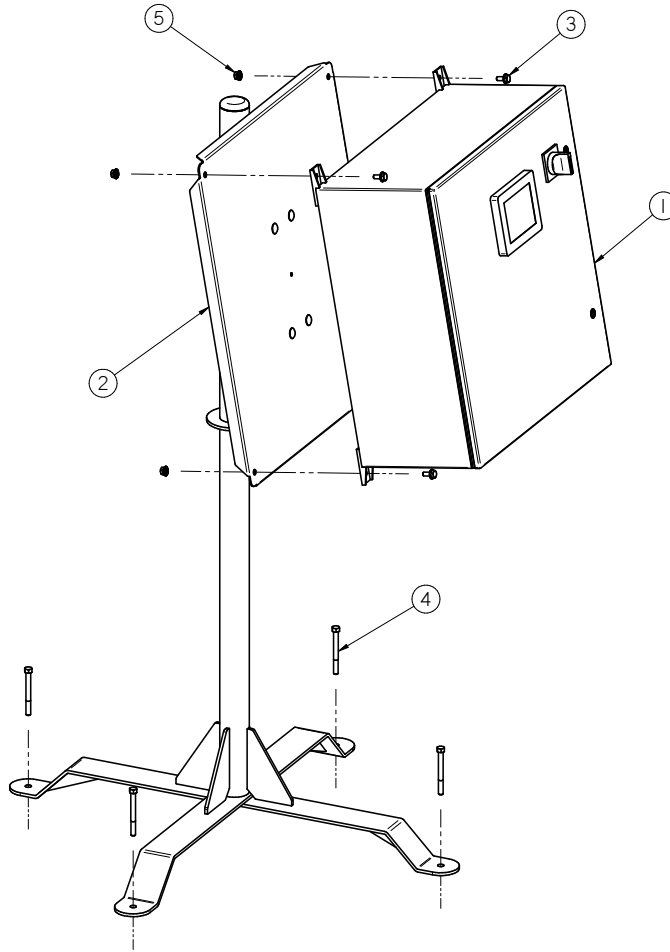

Item #	Part #	Description	Qty
1	SEE TABLE 1	CONTROL PANEL	1
2	05-03-1471	ASSY PNL FRM 4PUMP SAP	1
3	06-01-0124	BOLT, FLG .375-16 UNC ZP GRADE 5; 3/4" LG	4
4	06-01-0220	BOLT .375-16 X 3.75 CONCRETE ZP	4
5	06-03-0033	NUT LOCK FLG .375-16 GR8	4

TABLE 1	
Part #	Description
03-12-0355	CONTROL PANEL US4PC
03-12-0357	CONTROL PANEL US4PC WITH GUS CONTROLS

SEMI-AUTOMATED 4 PUMP CONTROLLER

NOTES:

USC LIMITED WARRANTY

SECTION J

USC, LLC, (Manufacturer) warrants its seed treating equipment as follows:

- 1. Limited Warranty:** Manufacturer warrants that the Products sold hereunder will be free from defects in material and workmanship for a period of 18 months from date of shipment. If the Products do not conform to this Limited Warranty during the warranty period, Buyer shall notify Manufacturer in writing of the claimed defects and demonstrate to Manufacturer satisfaction that said defects are covered by this Limited Warranty. If the defects are properly reported to Manufacturer within the warranty period, and the defects are of such type and nature as to be covered by this warranty, Manufacturer shall, at its expense, furnish replacement Products or, at Manufacturer's option, replacement parts for the defective products. Shipping and installation of the replacement Products or replacement parts shall be at the Buyer's expense.
- 2. Other Limits:** THE FOREGOING IS IN LIEU OF ALL OTHER WARRANTIES, EXPRESSED OR IMPLIED, INCLUDING BUT NOT LIMITED TO THE IMPLIED WARRANTIES OF MERCHANTABILITY AND FITNESS FOR A PARTICULAR PURPOSE. Manufacturer does not warrant against damages or defects arising from improper installation (where installation is by persons other than Manufacturer), against defects in products or components not manufactured by Manufacturer, or against damages resulting from such non-Manufacturer made products or components. Manufacturer passes on to the Buyer the warranty it received (if any) from the maker of such non-Manufacturer made products or components. This warranty also does not apply to Products upon which repairs and / or modifications have been effected or attempted by persons other than pursuant to written authorization by Manufacturer. This includes any welding on equipment which could damage electrical components. Manufacturer does not warrant against casualties or damages resulting from misuse and / or abuse of Products, improper storage or handling, acts of nature, effects of weather, including effects of weather due to outside storage, accidents, or damages incurred during transportation by common carrier.
- 3. Exclusive Obligation:** THIS WARRANTY IS EXCLUSIVE. The sole and exclusive obligation of Manufacturer shall be to repair or replace the defective Products in the manner and for the period provided above. Manufacturer shall not have any other obligation with respect to the Products or any part thereof, whether based on contract, tort, strict liability or otherwise. Under no circumstances, whether based on this Limited Warranty or otherwise, shall Manufacturer be liable for lost profits, lost revenue, lost sales (whether direct or indirect damages), incidental, special, punitive, indirect or consequential damages.
- 4. Other Statements:** Manufacturer's employees or representatives' oral or other written statements do not constitute warranties, shall not be relied upon by Buyer, and are not a part of the contract for sale or this limited warranty.
- 5. Return Policy:** Approval is required prior to returning goods to Manufacturer. A restocking fee will apply.
- 6. Entire Obligation:** This Limited Warranty states the entire obligation of Manufacturer with respect to the Products. If any part of this Limited Warranty is determined to be void or illegal, the remainder shall remain in full force and effect.

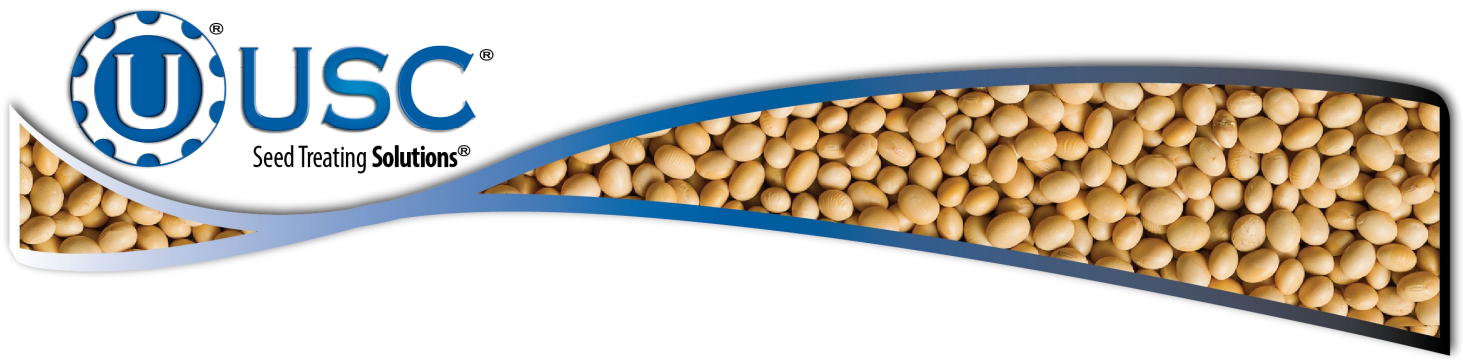

USC, LLC

2320 124th road

Sabetha, KS 66534

PHONE: (785) 431-7900

FAX: (785) 431-7950

EMAIL: sales-team@uscllc.com

WEB: www.uscllc.com

