

PUMP STAND WITH U-TREAT LITE

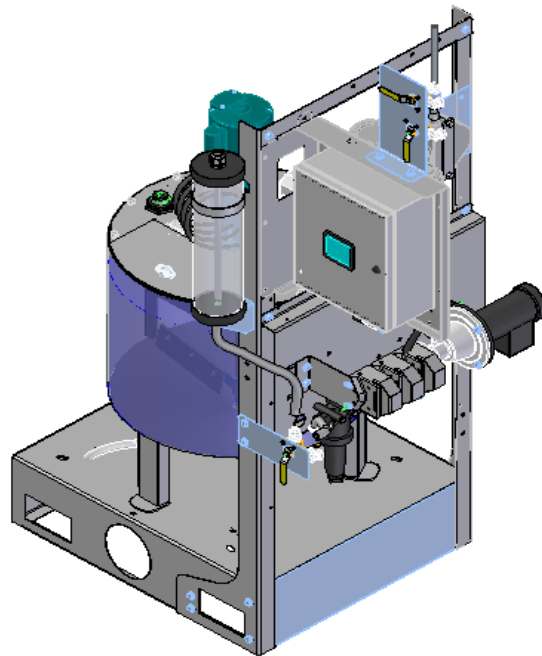

Software Release: v3.0.0

OPERATOR'S MANUAL

Document: TD-09-06-1063

Revision: A

Effective Date: 02-2020

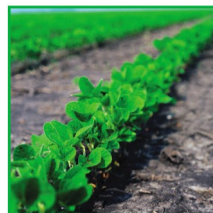

INTRODUCTION

Thank you for choosing USC, LLC for your equipment needs. We appreciate your business and will work diligently to ensure that you are satisfied with your choice.

OVERVIEW

The purpose of this manual is to provide you with the basic information needed to operate and maintain the Pump Stands. It does not hold USC, LLC liable for any accidents or injuries that may occur.

The technical information provided in this document is based on extensive testing under controlled conditions at the USC research and development facility. This information is given without guarantee as the conditions of operation and storage of the equipment are beyond our control. Variables such as temperature, humidity, viscosity of chemical products and changes in seed size or variety may all effect the accuracy of application and seed coverage. Periodically check the equipment calibration while treating and make adjustments as required. This will insure the optimum seed coverage.

RECEIVING YOUR EQUIPMENT

As soon as the equipment is received, it should be carefully inspected to make certain that it has sustained no damage during shipment and that all items listed on the packing list are accounted for. If there is any damage or shortages, the purchaser must immediately notify USC, LLC. Ownership passes to purchaser when the unit leaves the USC, LLC. premises. The purchaser is responsible for unloading and mounting all components of the equipment.

Document the serial number of the machine for future reference. The serial number is located on the back of the control panel mounting bracket.



SERIAL NUMBER: _____

TABLE OF CONTENTS

<u>Section</u>	<u>Contents</u>	<u>Page #</u>
Section A	Safety Instructions	4
Section B	Installation	13
Section C	Mechanical Operation.....	16
	Mix Tank, Calibration Tube.....	16
	Peristaltic Pump Heads & Pump Motor	17
	Automated Pump Stand Valves	18
	Flow Meters.....	19
Section D	Electrical Operation	20
Section E	Troubleshooting.....	47
Section F	Maintenance.....	48
Section G	Storage	52
Section H	Limited Warranty.....	55

SECTION A SAFETY INSTRUCTIONS

Every year accidents in the work place maim, kill and injure people. Although it may be impossible to prevent all accidents, with the right combination of training, operating practices, safety devices, and operator vigilance, the number of accidents can be significantly reduced. The purpose of this section is to educate equipment users about hazards, unsafe practices, and recommended hazard avoidance techniques.

If any of the required regularly scheduled maintenance is located above the reach of the operator, they should follow the companies normal safe practices of reaching that particular height, utilizing the companies specified equipment and following normal safety precautions.

When working with treatment chemicals, operators should always wear protective gloves, safety glasses, and follow the companies safety precautions in the case of any spillage or operator contamination.

SAFETY WORDS AND SYMBOLS

It is very important that operators and maintenance personnel understand the words and symbols that are used to communicate safety information. Safety words, their meaning and format, have been standardized for U.S. manufacturers and published by the American National Standards Institute (ANSI). The European Community (E.C.) has adopted a different format based on the International Standards Organization (I.S.O.) and applicable machinery directives. Both formats are presented below. Graphic symbols are not standardized, but most manufacturers will use some variation of the ones seen in this manual.



Indicates an imminently hazardous situation which, if not avoided, **will** result in death or serious injury.



Indicates a potentially hazardous situation which, if not avoided, **could** result in death or serious injury.



Indicates a potentially hazardous situation which, if not avoided, **may** result in minor or moderate injury and/or property damage.



Provides additional information that the operator needs to be aware of to avoid a potentially hazardous situation.



Notice is used to notify people of important installation, operation or maintenance information which is not hazard related.



Mandatory Lockout Power Symbol. Disconnect, lockout and tagout electrical and other energy sources before inspecting, cleaning or performing maintenance on this panel.



International Safety Alert Symbol. The exclamation point (!) surrounded by a yellow triangle indicates that an injury hazard exists. However, it does not indicate the seriousness of potential injury. The exclamation point (!) is also used with the DANGER, WARNING and CAUTION symbols so the potential injury is indicated.



Electrocution Hazard Symbol. This symbol indicates that an electrocution hazard exists. Serious injury or death could result from contacting high voltage.



International Electrocution Hazard. This symbol indicates that an electrocution hazard exists. Serious injury or death could result from contacting high voltage.



Mandatory Read Manual Action Symbol. (I.S.O. format) This symbol instructs personnel to read the Operators Manual before servicing or operating the equipment.

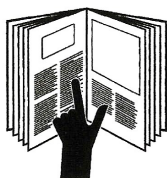

Mandatory Read Manual Action Symbol. This symbol instructs personnel to read the Operators Manual before servicing or operating the equipment.

LOCKOUT / TAGOUT PROCEDURES

Lockout/Tagout is the placement of a lock/tag on an energy isolating device in accordance with an established procedure. When taking equipment out of service to perform maintenance or repair work, always follow the lockout / tagout procedures as outlined in ANSI Z344.1 and/or OSHA Standard 1910.147. This standard “requires employers to establish a program and utilize procedures for affixing appropriate lockout devices or tagout devices to energy isolating devices and to otherwise disable machines or equipment to prevent unexpected energizing, start-up, or release of stored energy in order to prevent injury to employees.”

HAZARD REVIEW

Electrocution Hazard



Electrocution accidents are most likely to occur during maintenance of the electrical system or when working on or near exposed high voltage wiring. This hazard does not exist when the electrical power has been disconnected, properly locked, and tagged out.

Automatic Start Hazard



This equipment may be controlled by an automated system and may start without warning. Failure to properly disconnect, lockout, and tagout all energy sources of remotely controlled equipment creates a very hazardous situation and could cause injury or even death. PLEASE STAY CLEAR AND BE ALERT.

YOU are responsible for the **SAFE** operation and maintenance of your USC, LLC equipment. **YOU** must ensure that you and anyone else who is going to operate, maintain, or work around the treater be familiar with the operating and maintenance procedures and related **SAFETY** information contained in this manual. This manual will take you step-by-step through your working day and alert you to good safety practices that should be adhered to while operating the treater.

Remember, **YOU** are the key to safety. Good safety practices not only protect you, but also the people around you. Make these practices a working part of your safety program. Be certain that **EVERYONE** operating this equipment is familiar with the recommended operating and maintenance procedures and follows all the safety precautions. Most accidents can be prevented. Do not risk injury or death by ignoring good safety practices.

- Equipment owners must give operating instructions to operators or employees before allowing them to operate the machine, and at least annually thereafter per OSHA (Occupational Safety and Health Administration) regulation 1928.57.
- The most important safety device on this equipment is a **SAFE** operator. It is the operator's responsibility to read and understand **ALL** Safety and Operating instructions in the manual and to follow them. All accidents can be avoided.



PUMP STANDS PS10

- A person who has not read and understood all operating and safety instructions is not qualified to operate the machine. An untrained operator exposes himself and bystanders to possible serious injury or death.
- Do not modify the equipment in any way. Unauthorized modification may impair the function and/or safety and could affect the life of the equipment.
- Think SAFETY! Work SAFELY!

GENERAL SAFETY

1. Read and understand the Operator's Manual and all safety labels before operating, maintaining, adjusting or unplugging the pump stand .
2. Only trained persons shall operate the seed treater. An untrained operator is not qualified to operate the machine.
3. Have a first-aid kit available for use should the need arise, and know how to use it.
4. Provide a fire extinguisher for use in case of an accident. Store in a highly visible place.
5. Do not allow children, spectators or bystanders within hazard area of machine.
6. Wear appropriate protective gear. This includes but is not limited to:
 - A hard hat
 - Protective shoes with slip resistant soles
 - Protective goggles
 - Heavy gloves
 - Hearing protection
 - Respirator or filter mask
7. Place all controls in neutral or off, stop motor, and wait for all moving parts to stop. Then disable power source before servicing, adjusting, repairing, or unplugging.
8. Review safety related items annually with all personnel who will be operating or maintaining the Equipment.



OPERATING SAFETY:

1. Read and understand the Operator's Manual and all safety labels before using.
2. Disconnect and disable electrical supply completely and wait for all moving parts to stop before servicing, adjusting, repairing or unplugging.
3. Clear the area of bystanders, especially children, before starting.
4. Be familiar with the machine hazard area. If anyone enters hazard area, shut down machine immediately. Clear the area before restarting.
5. Keep hands, feet, hair and clothing away from all moving and/or rotating parts.
6. Stay away from overhead obstructions and power lines during operation and transporting. Electrocutation can occur without direct contact.
7. Do not operate machine when any guards are removed.

PLACEMENT SAFETY

1. Move only with the appropriate equipment
2. Stay away from overhead power lines when moving equipment. Electrocutation can occur without direct contact.
3. Be familiar with machine hazard area. If anyone enters hazard areas, shut down machine immediately. Clear the area before restarting.
4. Operate the equipment on level ground free of debris. Anchor the equipment to prevent tipping or upending.



Before placement of the equipment, be sure that ground is reasonably level. The equipment may topple or work improperly if the ground is too uneven, damaging the equipment and / or causing personal injury.

MAINTENANCE SAFETY

1. Review the operator's manual and all safety items before working with, maintaining or operating the equipment .
2. Place all controls in neutral or off, stop motors, disable power source, and wait for all moving parts to stop before servicing, adjusting, repairing or unplugging.
3. Follow good shop practices:
Keep service area clean and dry.
Be sure electrical outlets and tools are properly grounded.
Use adequate light for the job at hand.
4. Keep hands, feet, hair and clothing away from all moving and/or rotating parts.
5. Clear the area of bystanders, especially children, when carrying out any maintenance and repairs or making any adjustments.
6. Before resuming work, install and secure all guards when maintenance work is completed.
7. Keep safety labels clean. Replace any sign that is damaged or not clearly visible.





SAFETY LABELS

1. Keep safety labels clean and legible at all times.
2. Replace safety labels that are missing or have become illegible.
3. Replaced parts that displayed a safety label should also display the current label.
4. Replacement safety labels are available. Contact your local authorized dealer.

How to Install Safety Labels:

- Be sure that the installation area is clean and dry.
- Be sure temperature is above 50°F (10°C).
- Decide on the exact position before you remove the backing paper.
- Remove the smallest portion of the split backing paper.

 WARNING Located on the USC equipment you will find safety labels. Always be sure to read and follow all directions on the labels.

 WARNING Guards provided with USC equipment are to remain in place during operation.

PUMP STANDS PS10

- Align the sign over the specified area and carefully press the small portion with the exposed sticky backing in place.
- Slowly peel back the remaining paper and carefully smooth the remaining portion of the sign in place.
- Small air pockets can be pierced with a pin and smoothed out using the piece of sign backing paper.



Located on the USC equipment you will find safety labels. Always be sure to read and follow all directions on the labels.



Guards provided with USC equipment are to remain in place during operation.

PUMP STANDS PS10

Think **SAFETY!** Work **SAFELY!**

REMEMBER—If Safety Labels have been damaged, removed, become illegible, or parts replaced without safety labels, new labels must be applied. New safety labels are available from your authorized dealer.



Part # 09-02-0001

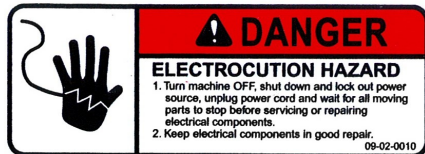

Part # 09-02-0010



INSTALLATION SECTION B



HIGH VOLTAGE ~ Always disconnect the power source before working on or near the control panel or lead wires.



HIGH VOLTAGE ~ Use insulated tools when making adjustments while the controls are under power.



Permanent installation may require additional electrical cords, chemical tubing, and air lines, since each installation is unique.

PUMP STAND SET - UP

The following steps outline the initial set-up of your Pump Stand:

1. Clear the area of bystanders, especially small children, before moving.
2. Be sure there is enough clearance from overhead obstructions and power lines or other equipment to move the pump stand(s) into its working position.
3. Using a forklift, place the pump stand in the desired position on a level surface.



USC highly recommends that the pump stand be set up inside a building or any covered structure to protect the machine from weathering.

4. Inspect machine thoroughly for screws, bolts, fittings, etc. which may have come loose during shipping.
5. Anchor to the floor with the floor mount type stand.
6. The pump stand(s) should be placed on level ground close to the seed treater.
7. Attach the chemical tubing from the pump stand(s) to the atomizer plumbing on the seed treater (below). Additional tubing can be added or removed to accommodate your set-up. (see page 14)
8. Have a certified electrician provide power to the seed treating system. Provide convenient shutdown switches, comply with local electrical codes and ensure that the system is properly grounded and bonded. The USC system must be connected to the same electrical requirements as specified in the main control panel on the power requirement tag, or the electrical schematic shipped with the piece of equipment.

PUMP STANDS PS10

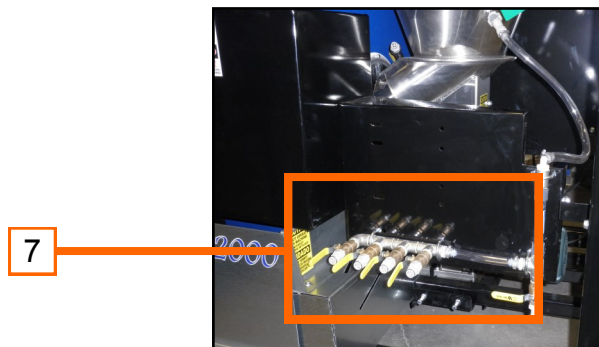

LOSS-IN-WEIGHT PUMP STAND SET - UP (BOX MOUNT)

1. After completing the installation above the following steps must be completed for the LIW pump stand (these are the ones with scales).
2. Remove the scale supports from between the scale top and the box mount. Save these for future use if you desire to move the pump stand later.
3. Lift the top of the scale off and level the scale base using the 4 adjustable legs. Note: the bubble must be directly in center of the circle. This step must be repeated if the pump stand is moved. Attach ground wire as shown on next page.
4. Replace the top of the scale.

LOSS-IN-WEIGHT PUMP STAND SET - UP (FLOOR MOUNT)

1. After completing the installation above the following steps must be completed for the LIW pump stand (these are the ones with scales).
2. Place the scale between the legs on the side opposite the pumps.
3. Lift the top of the scale off and level the scale base using the 4 adjustable legs. Note: the bubble must be directly in center of the circle. This step must be repeated if the pump stand is moved. Attach ground wire as shown on next page.
4. Replace the top of the scale.
5. Plug cable from scale into bottom of the control panel.

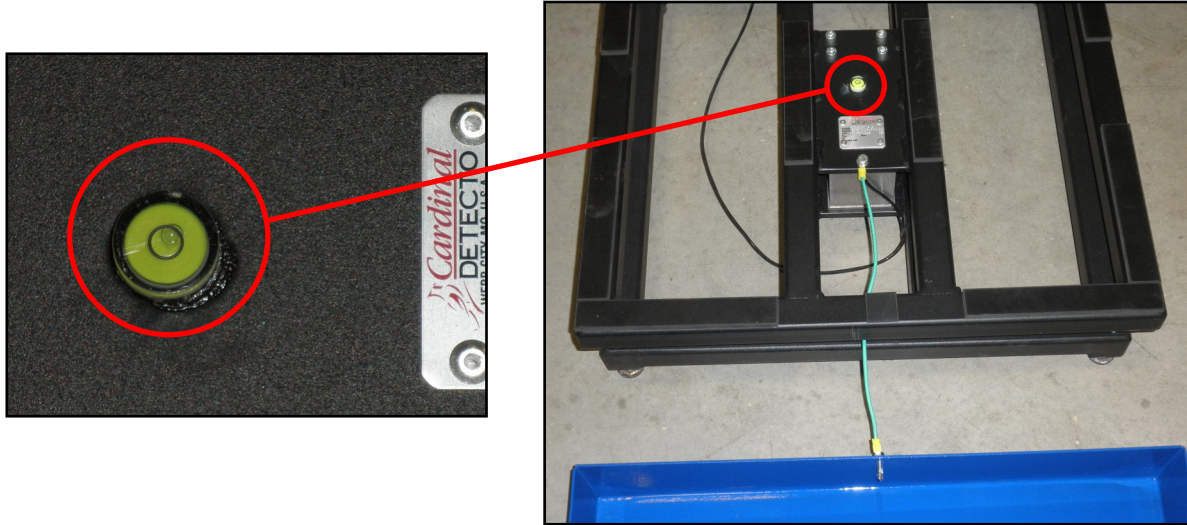

LOSS-IN-WEIGHT SCALE

When setting up a Loss In Weight pump stand, the scale must be balanced. Set the Cardinal scale on the floor in the location it will be operating from. The center of the scale has a leveling bubble on it. Use a 3/4" open end wrench to raise or lower the feet in the corners of the scale until the bubble is in the center ring. Lock down jam nuts on the feet for all four corners. The example shown below is not balanced.



The scale ground wire is shipped attached to the scale but not the cover. One side of the cover has a screw inserted. Set the cover on the balanced scale with that side on the same side as the ground wire. Remove the fastener, run it through the ground wire eyelet and re-attach it to the cover.

U-TREAT LITE VERSION 3 CONTROL PANEL NAMEPLATES

<p>FLOW METER PUMP STAND CONTROL PANEL</p> <p>!! WARNING !! 120V-240V / 1-PHASE / 50/60 HZ SUPPLY ONLY</p> <p>!! AVERTISSEMENT !! 120V-240V / 1-PHASE / 50/60HZ ALIMENTATION SEULEMENT</p>  <p>Mfg. By: USC, LLC Max Voltage: 120/240V, 1PH, 50/60Hz Total FLA: 3.6A @ 120V / 1.8A @ 240V Schematic Number: 03-12-0615A Enclosure Rating: UL Type 1 SCCR: 5kA RMS Sym, 600V Max</p>	<p>LOSS IN WEIGHT PUMP STAND CONTROL PANEL</p> <p>!! WARNING !! 120V-240V / 1-PHASE / 50/60 HZ SUPPLY ONLY</p> <p>!! AVERTISSEMENT !! 120V-240V / 1-PHASE / 50/60HZ ALIMENTATION SEULEMENT</p>  <p>Mfg. By: USC, LLC Max Voltage: 120/240V, 1PH, 50/60Hz Total FLA: 3.6A @ 120V / 1.8A @ 240V Schematic Number: 03-12-0616A Enclosure Rating: UL Type 1 SCCR: 5kA RMS Sym, 600V Max</p>
---	--

SECTION C MECHANICAL OPERATION

MIX TANKS

The pump stand includes a choice of 15, 30, 55 gallon poly or 30, 60, 100 gallon stainless steel chemical mix tank. The chemical mix tank will have electric drive agitation that is turned on or off at the pump stand with a manual switch. The agitator should be running at all times when treatment is present in the tank to keep the chemical mixed and in a suspended state. The tank is equipped with a shut-off, drain plug, and drain valve located on the bottom. The top of the tank also includes 3 extra ports which the operator may use to direct fill into the tank.



CALIBRATION TUBES

The pump stand may be equipped with an optional calibration tube which is used to check the liquid flow rate. The calibration tube is available in 100 OZ (low flow rates) and 300 OZ (high flow rates) only. The system valves direct liquid from different areas to keep all liquid contained. This creates a closed chemical system so that the operator may manually check the calibration of the chemical flow rate without handling any of the chemical.

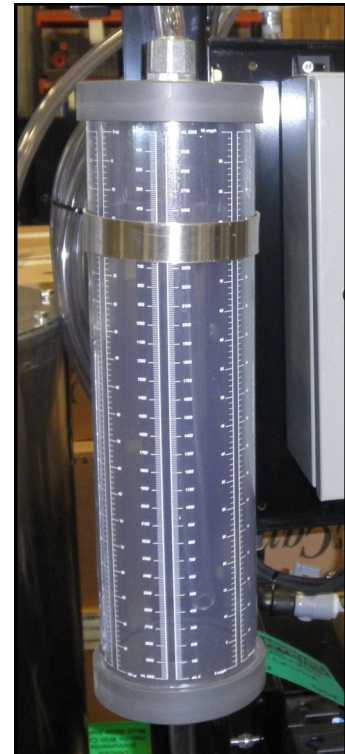

PERISTALTIC PUMP HEADS AND MOTOR

The pump stand utilizes a variable speed pump motor and special norprene pump tubing for liquid metering. The pump comes equipped with 1, 2 or 3 peristaltic pump heads. A Low Volume and High Volume configuration are also available. Liquid will only come into contact with the inside diameter of the pump tubing and not the pump. This allows for easy cleanup and less maintenance of the pump.

To open the pump head, lift the lever upward. Place the pump tubing inside the pump head so it fits inside the notches and above the rollers. Lower the lever back down to close the pump head, clamping the hose inside the head. Wear or fatiguing of the tubing within the pump head due to compression is normal. When tubing becomes worn or chemical rates begin to slow down, open the pump head and move the tubing to a different position. If the entire piece of tubing becomes worn, simply replace with a new section. When not using the pump stand for several days or when storing, open the pump head and remove the tubing to prevent any extra compression.

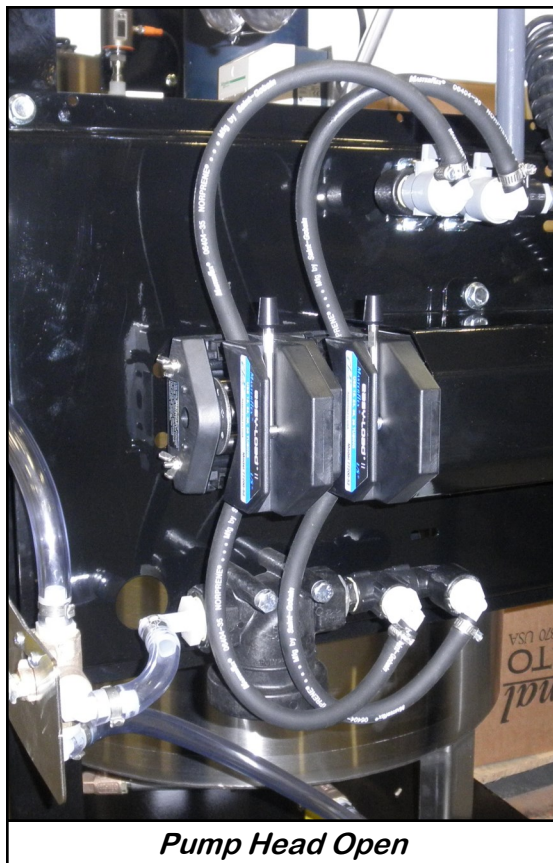

PUMP STAND VALVES

SEED TREATMENT SOURCE VALVE: This valve controls where the pump is drawing liquid from. It allows liquid to be pulled from either the bottom of the mix tank or the calibration tube. This valve is only present when a Calibration tube is mounted on the pump stand.



Drawing chemical from the bottom of the Mix Tank



Drawing chemical from the bottom of the Calibration Tube

MANUAL SEED TREATMENT RETURN VALVE: The bottom valve directs the liquid to the top valve or to the seed treater. The top valve directs the liquid coming from the mix tank or calibration tube or back to the calibration tube or mix tank for re-circulation.

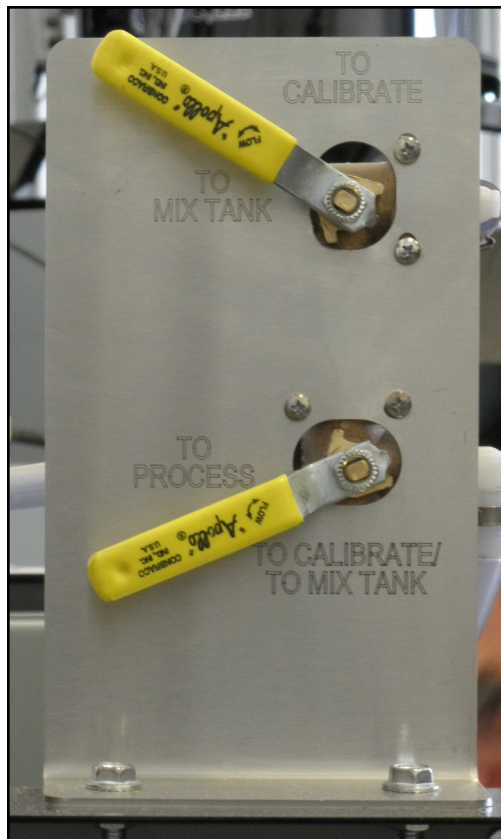

FLOW METERS

The pump stand may be equipped with an optional volumetric or mass flow meter. A flow meter is used to perform real - time chemical flow adjustments and monitoring without the operator having to handle the chemical. The flow meter reading will be displayed on the HMI touch screen and can be set to read in oz / min or ml / min.



Volumetric Flow Meter

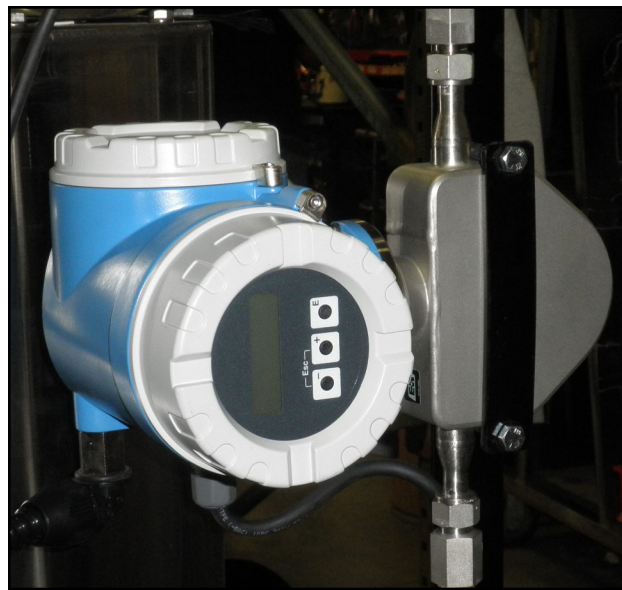

Mass Flow Meter

Proper calibration of the liquid system is critical to achieve a proper granular / chemical mixture. For information on pump calibration and flow meter calibration to determine liquid flow rate, see the appropriate U-Treat Automation manual.

Emptying the remaining liquid may be done by using the reverse function on the control panel. This will pump liquid back into the mix tank. Then drain the remaining liquid into a suitable container. Clean water should be pumped through the calibration tube and mix tank when finished.

⚠ WARNING

Always dispose of chemical or diluted chemical according to your local, state, and federal regulations.

NOTICE

Only you, the operator, can determine the length of time required to completely rinse all chemical residue from the tank and plumbing system.

SECTION
D**ELECTRICAL OPERATION**

HIGH VOLTAGE ~ Always disconnect the power source before working on or near the control panel or lead wires.



HIGH VOLTAGE ~ Use insulated tools when making adjustments while the controls are under power.



AUTHORIZED PERSONNEL only shall work on the control panel. Never allow anyone who has not read and familiarized themselves with the owner's manual to open or work on the control panels.

This section provides a general overview and description of the operator controls for the pump stands.

General Panel Descriptions

The pump stand control panels are plug connected enclosures that are located on each pump stand frame. Each pump stand has two standard 120V plugs. One for the manual ON/OFF switch controlling the mix tank motor (if equipped) and one for the pump stand control panel.

USC START UP SCREEN

While the system is booting up, the touch screen will display a timer bar in the middle of the Start Up Screen. Once the timer bar reaches the end it will disappear with a piece of text that reads "Press Screen to Continue". Select anywhere on the screen and it will advance to the Main Screen.



If it is the first time you are booting up your equipment you might see a user acknowledgement. Press "ACKNOWLEDGE" to accept user acknowledgment and continue.

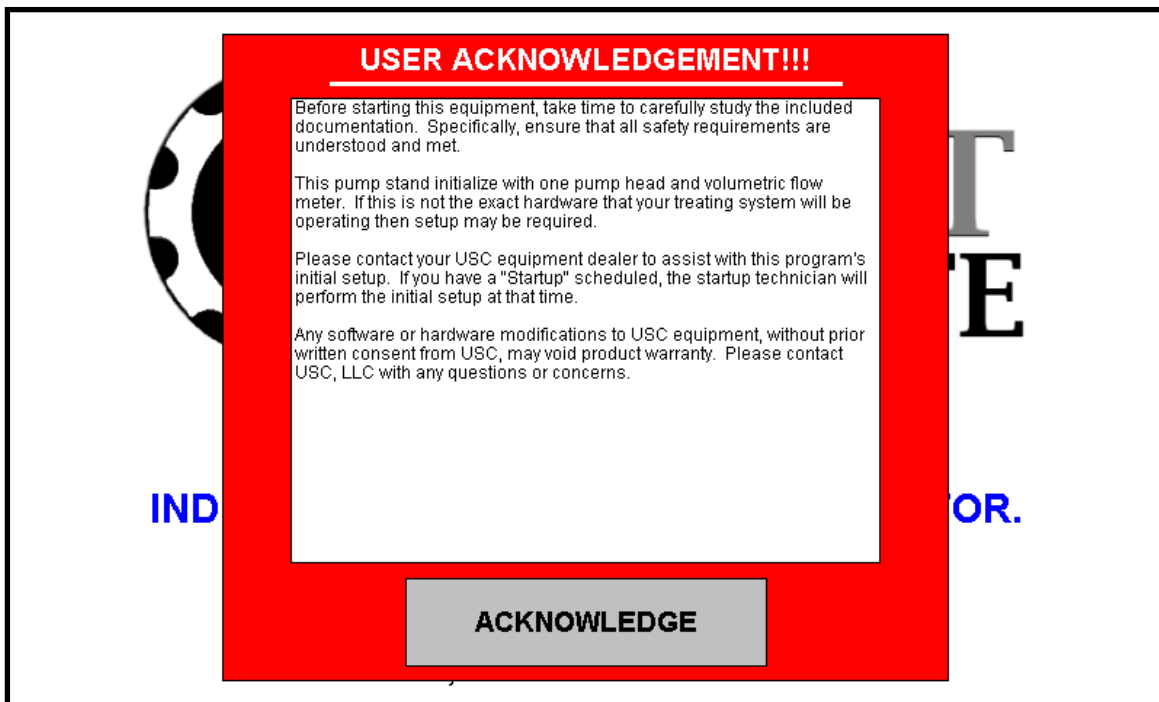

Main Screen

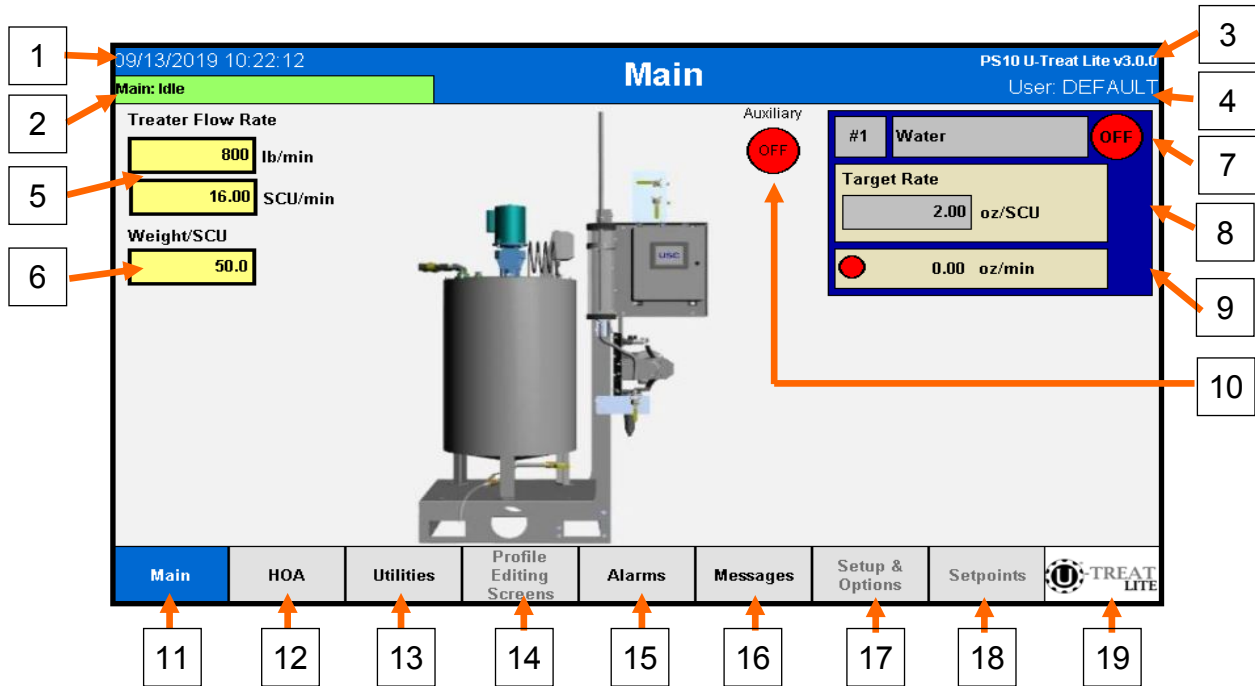

1. **Date and Time:** Displays the pump stand currently set Date and Time. By clicking on the Date and Time the operator is taken to the Date and Time page where a new Date and Time can be set.
2. **Program Status:** Displays the pump stands current status in the program. While idle with no device operating in, the status will display “Main: Idle”. When the pump is running in auto, the status will update to “Main: Running”.
3. **Program Version:** Displays the pump stands program version.
4. **User Display:** Displays the current user logged in. When the display is “User: Default” nobody is logged into the system. When the operator has logged in the display will change to “User: OPERATOR”. Finally a system admin will be displayed as “User: ADMIN”. By clicking on this display, we will be navigated to the login screen where we may enter our user name and password.
5. **Treater Flow Rate:** Displays the Treater’s flow rate information entered on the Utilities page. This is the flow rate the pump stand will assume the treater is operating at. For the top field, flow rate is shown in lb/min or kg/min depending on which measurement mode is selected. The second box shows the treaters rate in SCU’s / min.

Main Screen

6. **Weight/SCU:** Displays the Treater's seed weight per unit. This will be based off of the Seed Per Pound (or Kilogram) and Seed Per Unit entered on the Utilities page. This gives you the weight in every unit (calculated by Seed/Unit / Seed/lb).
7. **Chemical Selected / Motor Status:** The grey box on the top of the pump info area, allows selection of what chemical is selected and displays the currently selected chemical. By clicking this box, a new popup will appear to set what chemical we are using and at what rate we are applying the chemical at. We will discuss this pop-up further on page 26. In the upper right-hand corner of the pump info box, we have a motor indicator. When the pump motor is running the circle will be green and the text on the circle will display "on". When the pump motor is not running, the circle will be red with the text "off".
8. **Application Rate Details:** In the square below the chemical name, we show our current application rate. The application rates we show are oz/CWT (or oz/kg depending on measurement mode) or oz/SCU. By clicking anywhere in the pump info area we will open a new popup that allows chemical selection and application rate selection that we will discuss on page 26.
9. **Flow Rate Details:** Below this box is our current pump flow rate. This will be in oz/min (or mL/min depending on measurement mode). There is also a pump flow indicator beside the current flow rate if we are using a LIW pump. This indicator will be green when the pump detects flow is occurring and red when flow is not occurring.
10. **Auxiliary Status:** The auxiliary status indicator displays whether we are detecting an auxiliary signal or not. When the auxiliary signal is present, the indicator turns green and the text changes to "on". When no auxiliary signal is detected the indicator is red with the text "off".
11. **Main Screen Navigation Button:** This button will take the operator to the main screen.
12. **HOA Screen Navigation Button:** This button will take the operator to the HOA (Hands, Off, Auto) screen.
13. **Utilities Screen Navigation Button:** This button will take the operator to the Utilities screen.
14. **Profile Editing Screen Navigation Button:** This button will open a pop-up with additional navigation buttons for the Chemical Editing, Pump Stand Editing, and Import / Export screens. We will give additional information for this pop-up on page 37. This pop-up can only be accessed by an Operator or Admin user.
15. **Alarms Screen Navigation Button:** This button will take the operator to the Alarms screen. When an alarm is present the button will flash between red and grey.

16. **Messages Screen Navigation Button:** This button will take the operator to the Messages screen. When a message is present the button will flash between yellow and grey.
17. **Setup and Options Screen Navigation Button:** This button will take the operator to the Setup and Options screen. This screen can only be accessed by an Admin user.
18. **Setpoints Screen Navigation Button:** This button will take the operator to the Setpoints screen. This screen can only be accessed by a USC Dealer login.
19. **Splash Screen Navigation Button:** This button will take the operator to the Splash screen.

Main Screen (Alternates)

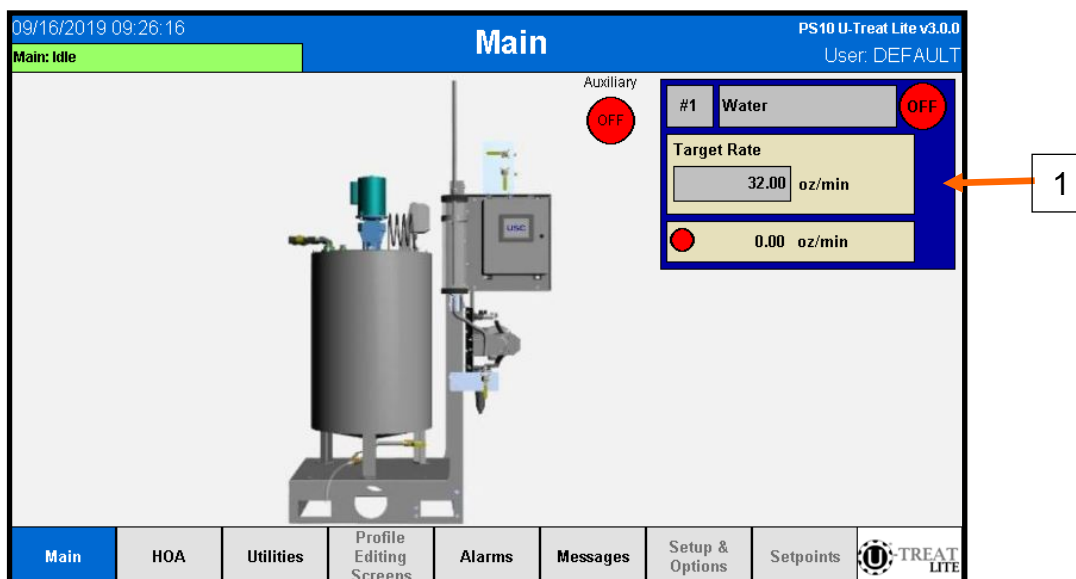

1. Target Rate (Direct Translate): While direct translate is enabled the entry shown will be the entry from the Utilities page. This option is also enabled on the utilities page. When this mode is enabled, the pump runs to a target flow rate in oz/min or mL/min depending on whether metric mode is enabled. This option is independent of seed or treater settings.

PUMP STANDS PS10

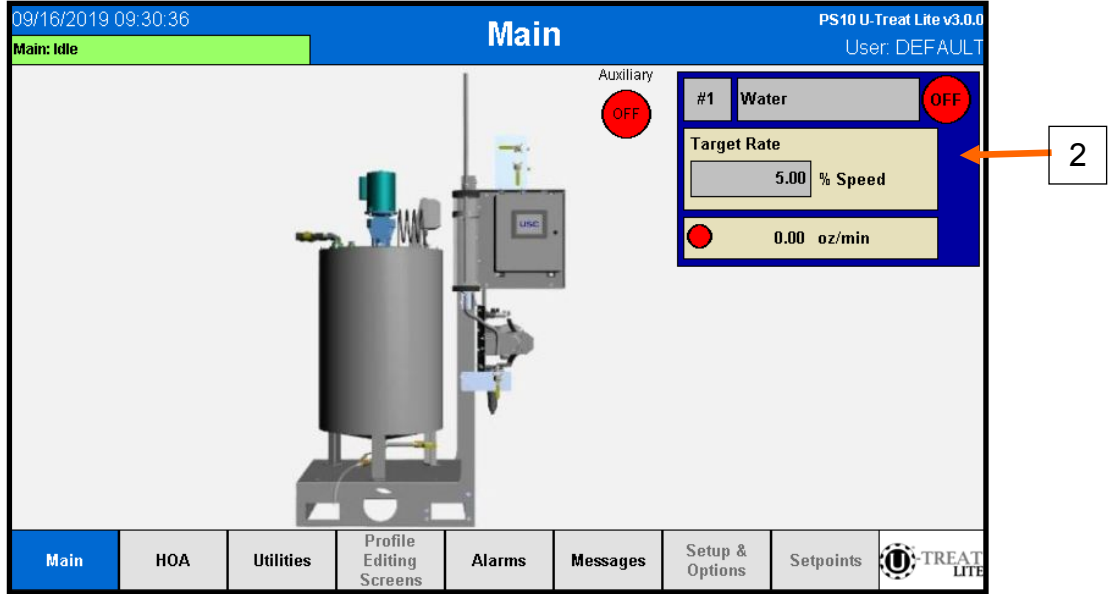

2. Target Rate (Manual Mode): While manual mode is enabled the entry shown will be the entry from the Utilities page. This option is also enabled on the utilities page. When this mode is enabled, the pump runs at a fixed motor percent speed. This option does not try to operate at any specific application rate or flow rate and instead keeps the pump motor running at a fixed speed.

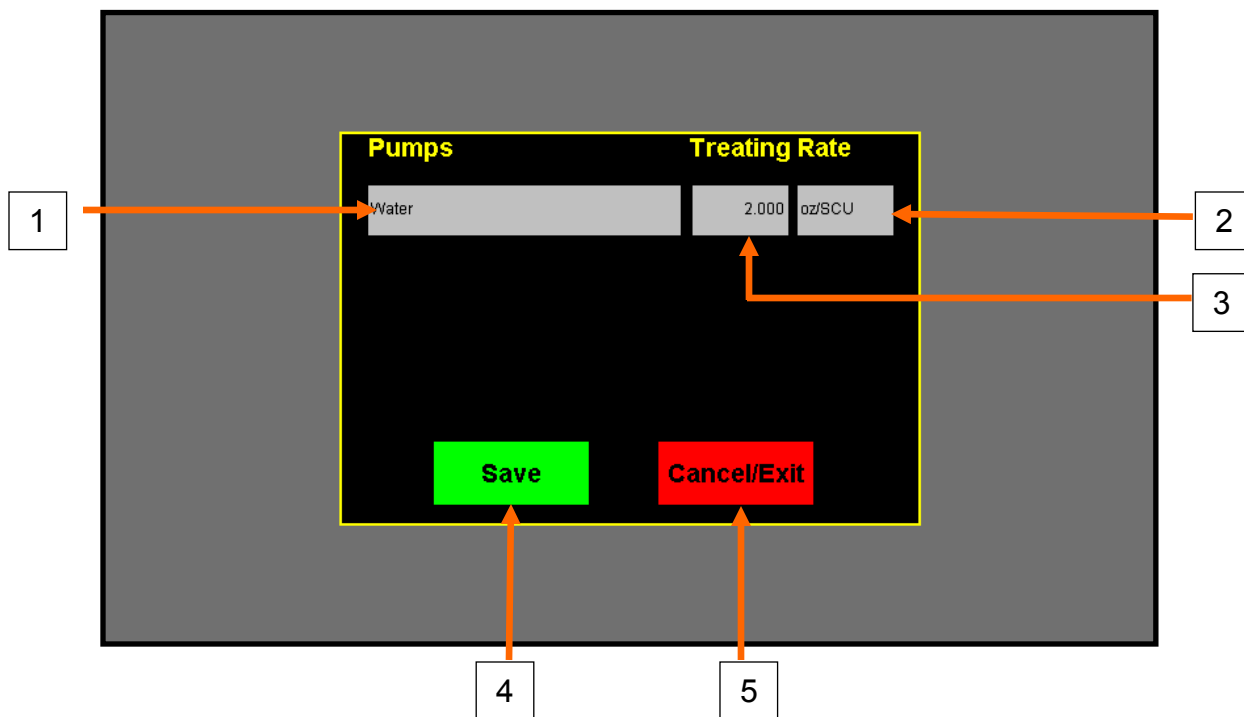
Pump Rate Pop-Up

The Pump Rate Pop-Up is accessible from the main screen of the PS10 program.

1. **Chemical Selection:** Displays the currently selected chemical. By clicking this box, a chemical selection list will appear showing all configured chemicals on the system. Select the chemical to use for the pumps operation.
2. **Application Rate Mode:** Displays which application rate mode is currently selected. The application rates are oz/CWT (if in metric oz/kg) or oz/SCU. By selecting this box, the system will change which application rate mode the operator is using. This mode selection is applied at the corresponding application rate to the left of this box.
3. **Application Rate Entry:** Displays currently selected application rate. By selecting this box we can enter a new application rate in which we want to apply product by. This rate will be applied by the corresponding application rate mode to the right of the entry.
4. **Save Button:** Selecting this button will save the desired chemical, application rate, and application entry to be used for automated runs.
5. **Cancel / Exit Button:** This button closes the pop-up and returns the operator to the main screen.

Select List Pop-Up

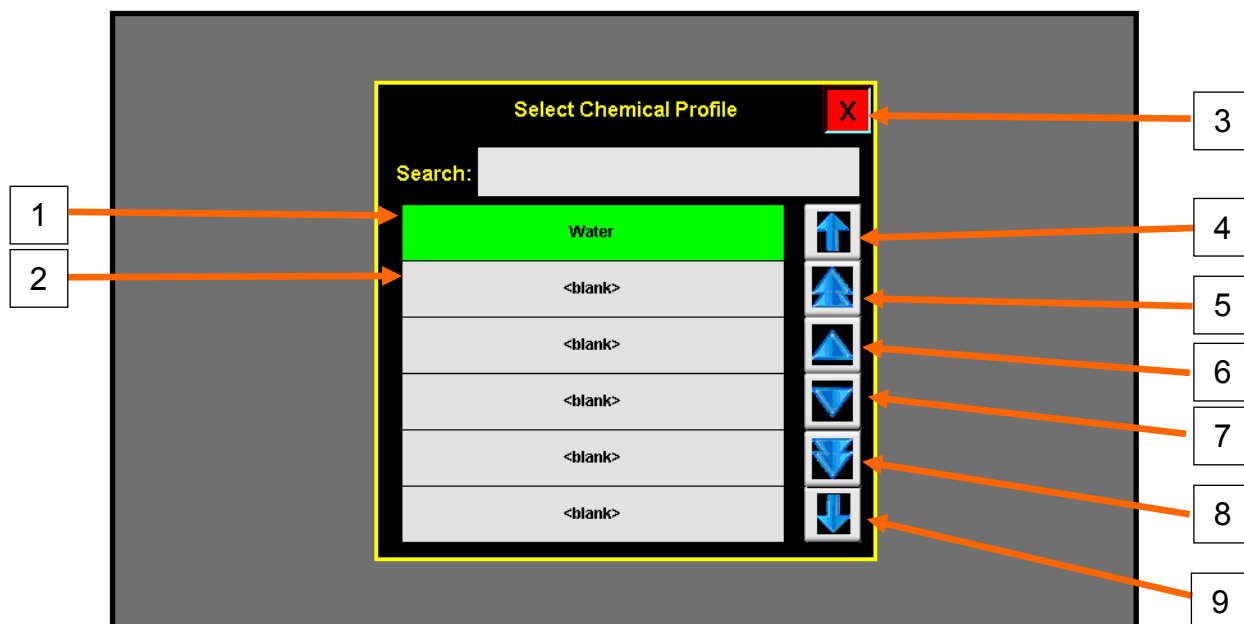

The Select List Pop-Up is accessible from the multiple screens of the PS10 program. It is available from the pump rate popup and chemical editing, alarms, and messages.

1. **Search Bar:** Allows the operator to type in parameters they wish to search by. Once the operator presses the enter key, the list will update and place the selection bar at the closest record to what was entered in the search bar.
2. **Selection List:** There are 6 selection items that can be selected from the selection list. Each item will display which profile will be loaded when the selection is made. The green highlight on the bar shows the currently selected item from the list.
3. **Close Button:** This button closes the pop-up and returns the operator to the previous screen.
4. **Home Button:** Selecting the selection list to the first record of the profile.
5. **Page Up Button:** This button moves the display list up one full page. With the page being 6 elements, pressing this button will move the list up 6 elements on the profile list.
6. **Up Button:** This button moves the display list up one entry.
7. **Down Button:** This button moves the display list down one entry.
8. **Page Down Button:** This button moves the display list down one full page. With the page being 6 elements, pressing this button will move the list down 6 elements on the profile list.
9. **End Button:** Selecting the selection list to the last record in the profile list.

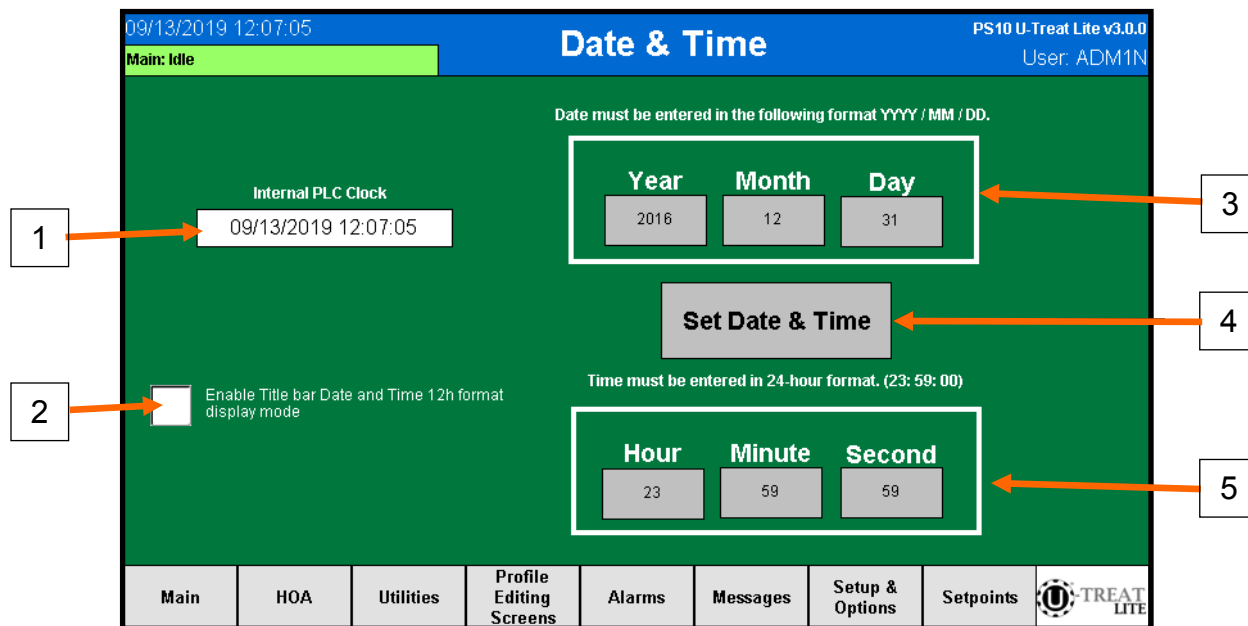

1. **Internal PLC Clock:** Displays the currently set time for the pump controller.
2. **12 hour Format Mode:** This option toggles between using a 24 hour clock and using a 12 hour clock.
3. **Year/Month/Day Entry:** By selecting the box under the “Year” text, the operator may enter the year they wish to set the pump controller to. By selecting the box under the “Month” text, the operator may enter the month they wish to set the pump controller to. By selecting the box under the “Day” text, the operator may enter the day they wish to set the pump controller to.
4. **Set Date & Time Button:** Selecting this button will set the time entered in the Year/ Month/Day entry and the Hour/Minute/Second entry to the pump controller. The time will update the display for the Internal PLC Clock and the Date and time display in the upper left hand corner of the Title Bar.
5. **Hour/Minute/Second:** By selecting the box under the “Hour” text, the operator may enter the hour they wish to set the pump controller to. By selecting the box under the “Minute” text, the operator may enter the minute they wish to set the pump controller to. By selecting the box under the “Second” text, the operator may enter the seconds they want to set the pump controller to.

Security Screen

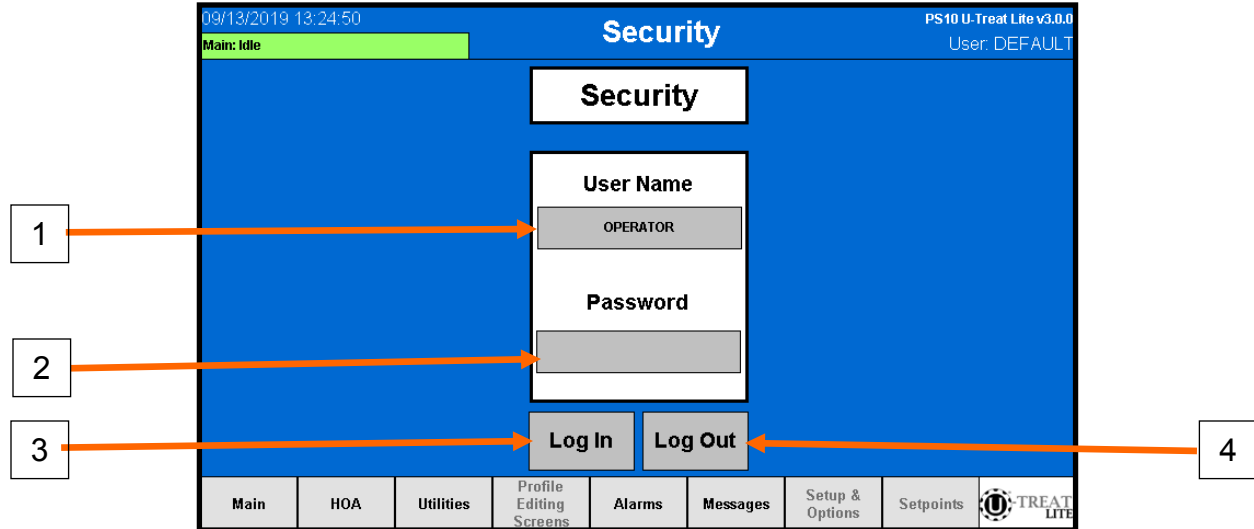

1. **User Name Entry:** By selecting this field, the operator can enter the username they wish to log in with. This field is case sensitive.
2. **Password Entry:** By selecting this field, the operator can enter the password corresponding to the username entered above. This field is case sensitive.
3. **Log In Button:** By selecting the Log In button the pump stand controller will attempt to login with the Username and Password provided above. If the correct Username and Password has been entered the User display in the lower right hand corner of the title bar. If an incorrect Username or Password has been entered the User Name Entry will return to default.
4. **Log Out Button:** By selecting the Log Out button the pump stand controller will log the current user out and return to the default user.

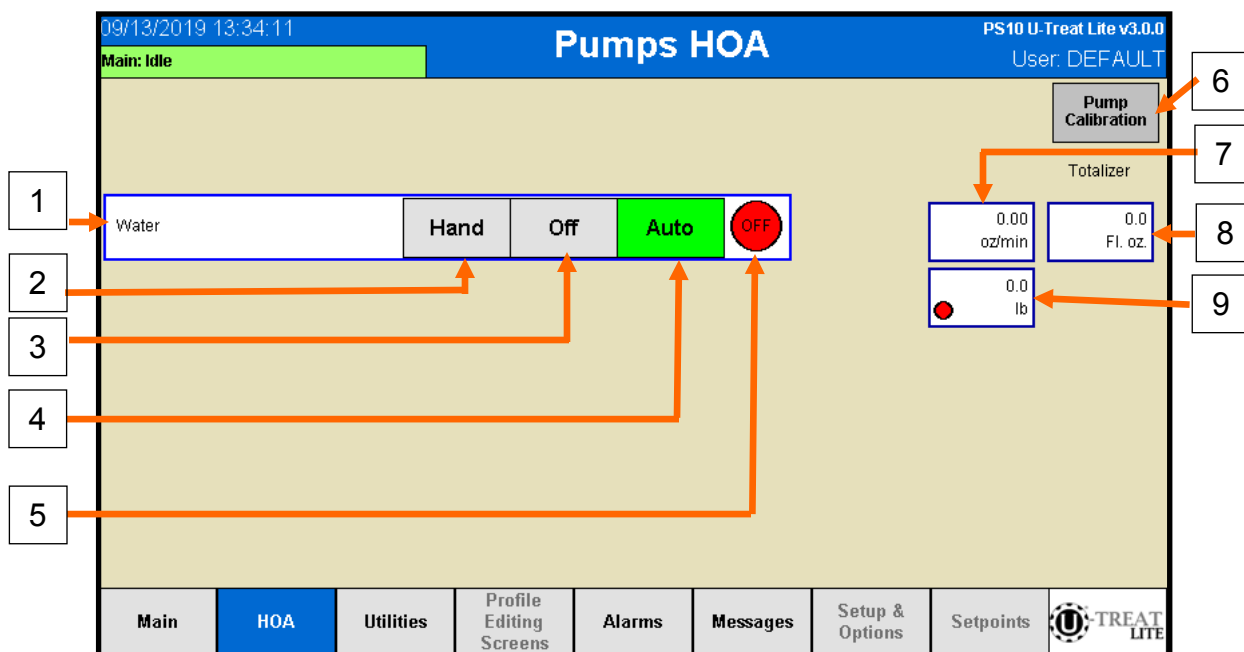
HOA Screen

1. **Chemical Display:** Displays the currently selected chemical on the pump.
2. **Hand Button:** Selecting the “Hand” button will put the motor into hand operation. This is a non-automated operation to directly control the pump. The pump will run at a rate/speed based off the selected information on the Utilities Page.
3. **Off Button:** Selecting the “Off” button will turn the motor off. This is a non-automated operation to ensure the motor stays off.
4. **Auto Button:** Selecting the “Auto” button will put the motor into automatic state. This is an automated operation of the motor. The pump in auto will turn on / off based off the auxiliary signal and the pumps start and stop delays automatically. The pump will run at the desired rate/speed based off the selected information on the Utilities Page.
5. **Motor Status:** When the pump motor is running the circle will be green and the text on the circle will display “on”. When the pump motor is not running, the circle will be red with the text “off”.
6. **Pump Calibration Button:** Selecting the pump calibration button will open the pump calibration pop-up. We will discuss the pop-up further on page 30.
7. **Flow Rate Display:** This display shows the current flow rate in oz/min (or mL/min in metric) of the pump.
8. **Totalizer Display:** This display shows the current accumulated oz (or mL in metric) of the pump stand. To reset the totalizer, click on the display to return the total amount to 0.

9. **Scale Weight Display:** This display shows the current scale weight on the LIW scale. This display is only visible if the pump is configured as a LIW pump. The pump will display in lbs or kgs depending on whether metric mode is enabled or disabled. There is also a flow detection indicator on the scale weight display. This indicator will be green when the pump detects flow is occurring and red when flow is not occurring.

Pump Calibration Pop-Up

The screenshot shows a 'Pump Calibration Pop-Up' window with the following elements and callouts:

- 1:** Help button
- 2:** Target Run Time (seconds): 30
- 3:** Target Rate (oz/min): 32.0
- 4:** Rough Est. Total (Fl. oz): 16.00
- 5:** Cal. Tube Total (Fl. oz): 1.00
- 6:** Pump Totalizer (Fl. oz): 1.00
- 7:** Elapsed Run Time (seconds): 0.0
- 8:** Processing Calibration bar
- 9:** Chemical Name: Water
- 10:** Actual Rate (oz/min): 0.0
- 11:** Jog Pump Motor button
- 12:** START button
- 13:** STOP button
- 14:** Current Ratio: 1.00
- 15:** Current Density (lb/gal): 8.33
- 16:** Calculated Density (lb/gal): 8.33
- 17:** Update Density button

The Pump Calibration Pop-Up is accessible from the HOA screen of the PS10 program.

1. **Help Button:** Navigates to the pump calibration help page. This page describes several of the objects on the page.
2. **Target Run Time:** Target run time is the amount of time the operator wishes to run the pump in calibration. When the start button is pressed the pump will turn on, if in auto, for the requested amount of time entered on this entry.
3. **Target Rate:** Displays the current target rate selected for the run. This rate is set based off the Main and Utilities screen. The rate will be in oz/min in standard and mL/min in metric.
4. **Rough Est Total:** This entry calculates how many oz in standard or mL in metric the calibration run will accumulate. This number is based off the "Target Run Time" and the "Target Rate" above.
5. **Cal Tube Total:** After an calibration run has occurred, the operator may enter the actual amount caught in the calibration tube for the program to compare against its internally calculated totalizer. This amount should be entered in oz for standard and mL for metric.
6. **Pump Totalizer:** After a calibration run has occurred, the program will calculate how many oz in standard or mL in metric it calculated had occurred. By entering the calibration tube total in the entry above, the program can use these two numbers to calculate a new calibration ratio for the chemical.
7. **Elapsed Run Time:** During a calibration run, this entry shows how many seconds the pump has ran.
8. **Calibration Timer Bar:** This bar will show the progress of the calibration during a calibration run. It will show the elapsed run time in blue as a calibration run occurs. The maximum point of the bar will be the target run time.
9. **Chemical Name:** Shows the currently selected chemical name.
10. **Actual Rate:** Shows the actual rate the pump is running at during a calibration run. This display will show oz/min in standard and mL/min in metric. If the pump stand is configured as a LIW pump stand, there will also be a flow detection indicator. This indicator will be green when the pump detects flow is occurring and red when flow is not occurring.
11. **Job Pump Motor:** This button toggles the pump motor on or off. This is used to help assist in setting the calibration tube to its minimum position (0). This can also be used to help prime the chemical lines.
12. **Stop Button:** This button stops the calibration run.
13. **Start Button:** This button starts the calibration run. The run will run at the rate dis-

Pump Calibration Pop-Up

played for the amount of time requested in the “Target Run Time” entry. The run will automatically shut off when the “Elapsed Run Time” reaches the ”Target Run Time” or if the stop button has been pressed.

- 14. **Calibration Ratio:** Displays the current calibration ratio of the chemical selected. This entry is visible when the pump stand is configured as a LIW pump.
- 15. **Current Density:** Current density of the chemical being used for the calibration runs. This entry is visible when the pump stand is configured as a LIW pump.
- 16. **Calculated Density:** Density calculated based off the calibration tube amount and scale weight. The program will use the calibration tube amount and the scale weight to calculate a new density for the chemical. This entry is visible when the pump stand is configured as a LIW pump.
- 17. **Update Density Button:** This button updates the chemical with the newly calculated density. This entry is visible when the pump stand is configured as a LIW pump.

Pump Calibration Pop-Up (Alternate)

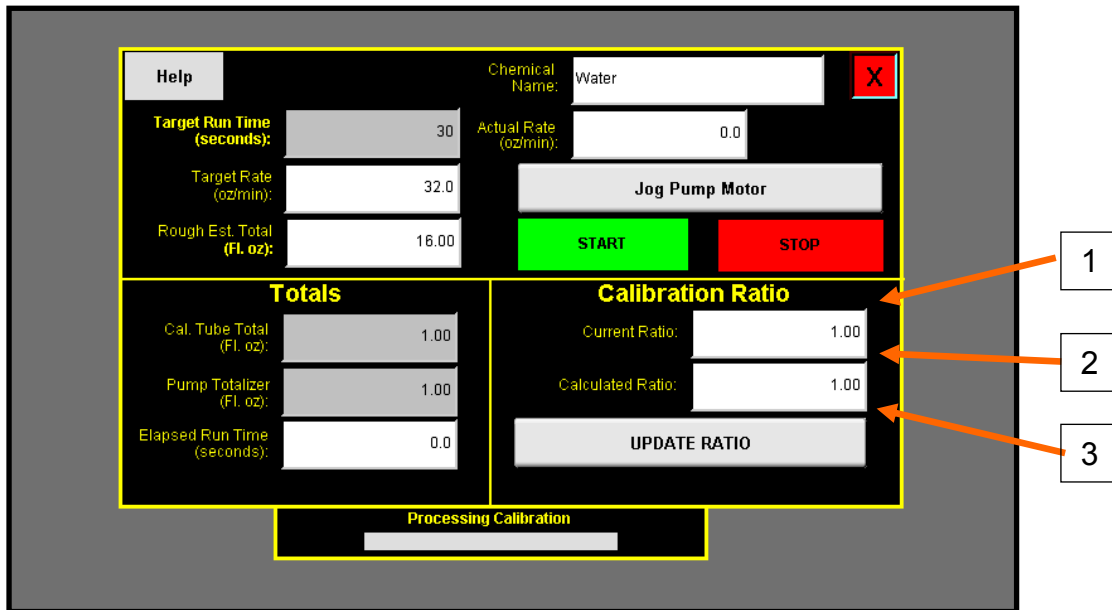

PUMP STANDS PS10

The Pump Calibration Pop-Up is accessible from the HOA screen of the PS10 program.

1. **Current Ratio** Current calibration ratio of the chemical being used for the calibration runs. This entry is visible when the pump stand is configured as a flow meter pump.
2. **Calculated Ratio:** Calibration ratio calculated based off the calibration tube entry and pump totalizer. The program will use the calibration tube amount and the pump internal totalizer amount to calculate a new calibration ratio for the chemical. This entry is visible when the pump stand is configured as a flow meter pump.
3. **Update Ratio Button:** This button updates the chemical with the newly calculated density. This entry is visible when the pump stand is configured as a flow meter pump.

Utilities Page

1 → Target Treating Rate (SCU/min) 16.00 800 lb/min

2 → Seed Per Pound 2800

3 → Seed Per Unit 140000

4 → Batch Time (Seconds) 60.0

5 → Treat by SCU/min Batch Mode

6 → Direct Translate

7 → Manual (Percent) Mode

8 →

1. **Target Treating Rate:** Selecting the grey box allows the operator to enter the target treating rate in either lb/min (kg/min if in metric) or SCU/min depending on whether “Treat by SCU/min” check box is selected. There is also a display that shows what lb/min (kg/min if in metric) or SCU/min depending on the “Treat by SCU/min” check box. Target Treating Rate is only visible while “Direct Translate” and “Manual (Percent) Mode” is not enabled.
2. **Seed Per Pound:** Selecting the grey box allows the operator to enter what the seed per pound (or seed per kilogram if in metric) is for the product the pump is going to apply chemical to. This will help aid in any SCU based chemical application. Seed Per Pound is only visible while “Direct Translate” and “Manual (Percent) Mode” is not enabled.

Utilities Page

3. **Seed Per Unit:** Selecting the grey box allows the operator to enter what the seed per unit is for the product the pump is going to apply chemical to. This will aid in any SCU based chemical application. Seed Per Pound (Seed per Kilogram in metric) is only visible while “Direct Translate” and “Manual (Percent) Mode” is not enabled.
4. **Batch Time:** Selecting this grey box allows the operator to enter how long the pump will run when in auto, after the auxiliary signal comes on. If the auxiliary signal comes off before the timer has completed, the timer will reset. Once the time is met, the pump will stop running until the auxiliary signal is turned off and back on again. This option is only available while “Batch Mode” is enabled.
5. **Treat By SCU/min:** Selecting this check box allows the operator to switch from entering the target treating rate by SCU/min or by lb/min (or kg/min if in metric).
6. **Batch Mode:** Selecting this check box allows the operator to turn batch mode off or on. Batch mode allows the operator to only run the pump for a desired amount of time while in auto after the auxiliary signal turns on.
7. **Direct Translate:** Selecting this check box allows the operator to enable direct translate mode. This mode takes away treater based option, and allow the operator to enter a requested flow rate by oz/min or mL/min in metric.
8. **Manual (Percent) Mode:** Selecting this check box allows the operator to enable manual mode. Manual mode runs the pumps motor at a % motor speed instead of trying to achieve a targeted application or flow rate.

Utilities Page (Alternates)

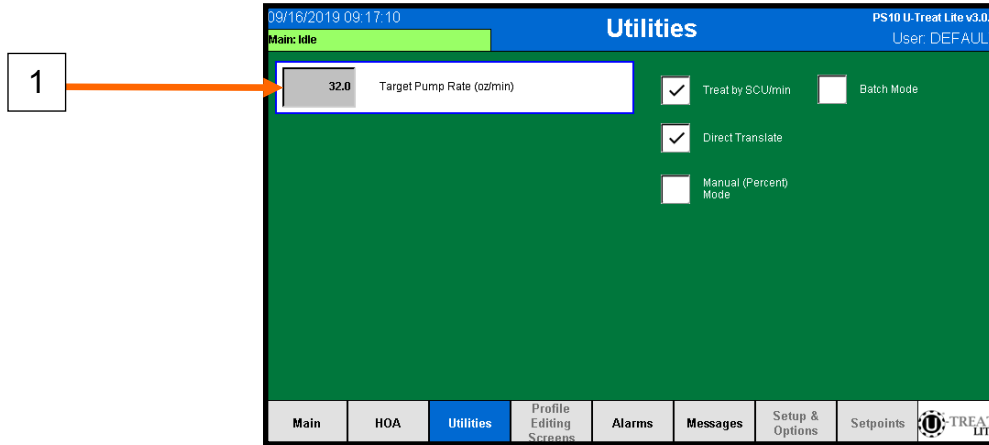

1. Target Pump Rate: Selecting the grey box allows the operator to enter the target pump rate by either oz/min or mL/min. This rate is independent of any treater or seed information and will strictly try and achieve the requested flow rate. This option appears when the “Direct Translate” check box is selected.

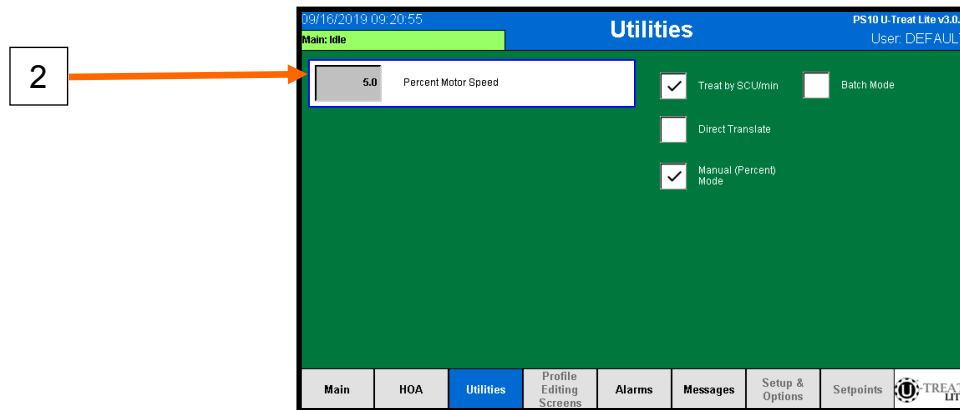

2. Percent Motor Speed: Selecting the grey box allows the operator to enter the percent motor speed. This speed is a fixed motor speed percent where the pump is not trying to achieve a specific flow rate. This option is only visible when “Manual (Percent) Mode” check box is selected.

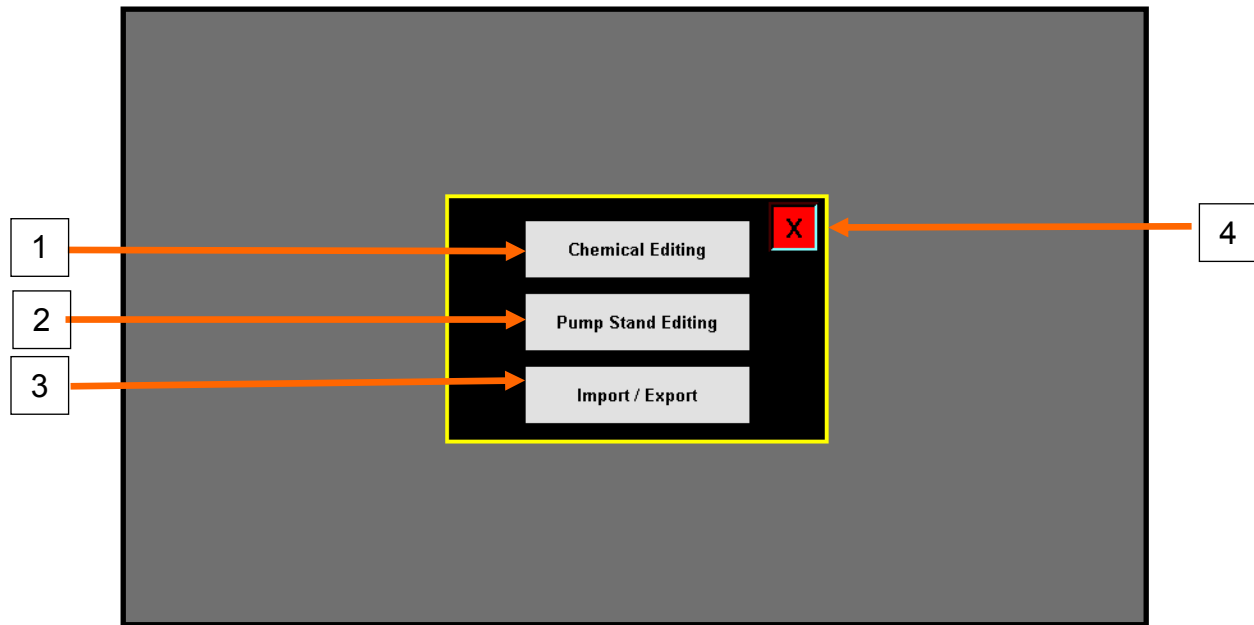
Profile Editing Pop-Up

The Profile Editing Pop-Up is accessible from the navigation bar of the PS10 program.

1. **Chemical Editing Navigation Button:** Selecting the chemical editing navigation button, takes us to the chemical editing page where we can create different chemicals our pump stand is going to be outfitted with. This button is only accessible to OPERATOR or higher user levels.
2. **Pump Stand Editing:** Selecting the Pump Stand Editing navigation button takes us to our pump stand editing page where we configure and setup our pump stand. This is where we configure the physical properties of our pump stand, such as what motor we are using and how many pump heads are configured. This button is only accessible to ADMIN or higher user levels.
3. **Import / Export:** Selecting the Import / Export navigation button takes us to our pump stand's import export screen. This is where we can import or export our chemical profiles, and pump stand settings. From here we can also delete our alarms and messages. This is only accessible to ADMIN or higher user levels.
4. **Close Button:** By selecting the "X" button in the upper left hand corner of any popup, closes the popup and returns the operator to the previous screen.

Chemical Editing Screen

1. **Selection List Button:** Selecting this button opens a display list popup which allows for the selection of what chemical profile we would like to edit.
2. **Copy Button:** Selecting this button copies all fields except the name of the currently selected profile. This is used with the Paste button to select another entry and paste contents into another profile.
3. **Paste Button:** Selecting this button pastes all fields except the name of the current selected profile. This is used with the copy button to paste copied contents into the currently selected profile.
4. **Save Button:** Selecting this button saves the currently selected profile.
5. **Name Field:** This field allows the operator to assign a name to the chemical they are operating. The system sorts chemicals by name.
6. **Chem Calb Factor:** This field allows the operator to enter a calibration factor for the chemical profile. This factor adjust the flow meter reading when using a flow meter style pump. If using a LIW pump this factor adjust the initial speed of the pump. The default for this field is 1.0 and can be adjusted using the calibration popup on the HOA page.
7. **Chem Calb Factor Adj:** This field is only visible when the pump is configured as a LIW pump. Selecting this field toggles between Auto L-I-W or Manual. When in Auto L-I-W the LIW pump will automatically adjust the calibration factor to adjust its starting speed. Every run the pump will evaluate its flow rate after it collects data form the scale and adjust its starting speed to more accurately hit the desired rate. In manual mode, the operator may enter his own calibration factor to set his start-

ing speed at.

8. **Density:** This field is only visible when the pump is configured as a LIW pump. This is where the operator may enter the density of the chemical they will outfit the pump with. The density aids the LIW pump calculate how many fl. oz. or ml. the pump has processed.
9. **Clear Button:** Selecting this button clears the currently selected profile to a blank default record.

Pump Stand Editing Screen

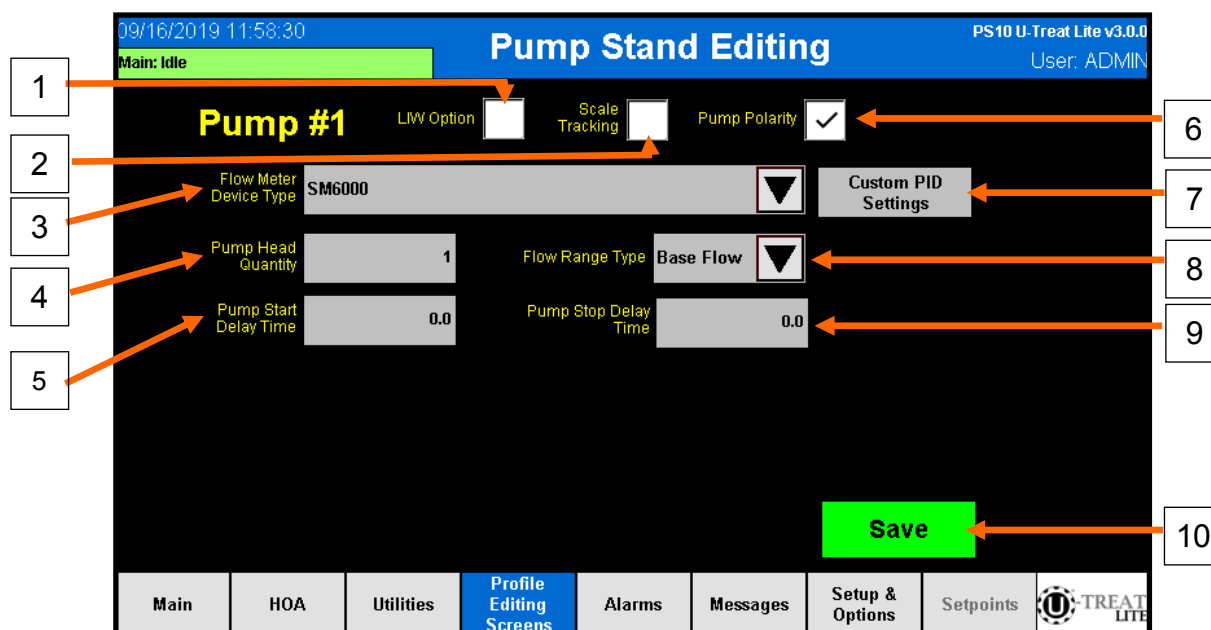

1. **LIW Option:** Selecting this option toggles the pump stand type between LIW and Flow Meter Type pump.
2. **Scale Tracking:** Selecting this option toggles on or off the scale tracking features. Scale tracking allows for the setting of “Pump Alarm Weight” and “Pump Warning Weight” which sets the alarm weight and message weight respectively.
3. **Flow Meter Device Type:** The flow meter type selection is only visible when a flow meter pump is configured (LIW Option disabled). By selecting this field a drop down list will appear allowing the operator to select from SM6000, 80E08, SM6001, and Custom flow meters.
4. **Pump Head Quantity:** This field allows the operator or dealer to configure how many pump heads the pump stand has been outfitted with. This helps the program determine how aggressively to run the pump.
5. **Pump Start Delay Time:** This field allows the operator to delay the starting of the pump when in auto and the auxiliary signal is active. This allows for more precise timing of the chemical application at the start of an automated run.

Pump Stand Editing Screen

6. **Pump Polarity:** Selection this option toggles the pumps motor direction.
7. **Custom PID Settings:** This button opens the custom PID popup for use when custom flow meter is selected from the “Flow Meter Device Type” selection. Here we can enter customer PID settings to operate the pump with a customer aggressiveness.
8. **Flow Range Type:** This selection allows the operator or dealer to configure which flow range motor the pump has been outfitted with. The options are low flow, base flow, and high flow.
9. **Pump Stop Delay Time:** This field allows the operator to delay the stopping of the pump when in auto and the auxiliary signal is goes inactive. This allows for more precise timing of the chemical application at the end of an automated run.
10. **Save Button:** The save button is used to save the current settings to the pump stand.

Pump Stand Editing (Alternate)

The screenshot displays the 'Pump Stand Editing (Alternate)' interface. At the top, it shows the date and time '09/16/2019 12:42:45', the title 'Pump Stand Editing', and the version 'PS10 U-Treat Lite v3.0.0'. The user is identified as 'ADMIN'. The main area is titled 'Pump #1' and contains several settings: 'LW Option' (checked), 'Scale Tracking' (checked), and 'Pump Polarity' (checked). Below these are input fields for 'Pump Head Quantity' (1), 'Flow Range Type' (Base Flow), 'Pump Start Delay Time' (0.0), 'Pump Stop Delay Time' (0.0), 'Warning Weight' (-1000), and 'Alarm Weight' (-1000). A green 'Save' button is located at the bottom right. A navigation bar at the bottom includes 'Main', 'HOA', 'Utilities', 'Profile Editing Screens' (highlighted), 'Alarms', 'Messages', 'Setup & Options', 'Setpoints', and the 'U-TREAT LITE' logo. Two orange arrows point to the 'Warning Weight' and 'Alarm Weight' fields, with labels '1' and '2' in boxes.

1. **Warning Weight:** This entry is visible when scale tracking has been enabled. The operator may enter a weight they wish to receive a warning at on a scale. A warning will alert the operator when the chemical amount is getting low based off scale weight, however will not shut down or prevent a run.
2. **Alarm Weight:** This entry is visible when scale tracking has been enabled. The operator may enter a weight they wish to receive a alarm at on a scale. A alarm will shut down the run when the chemical amount is too low based off scale weight.

Custom PID Settings Pop-Up

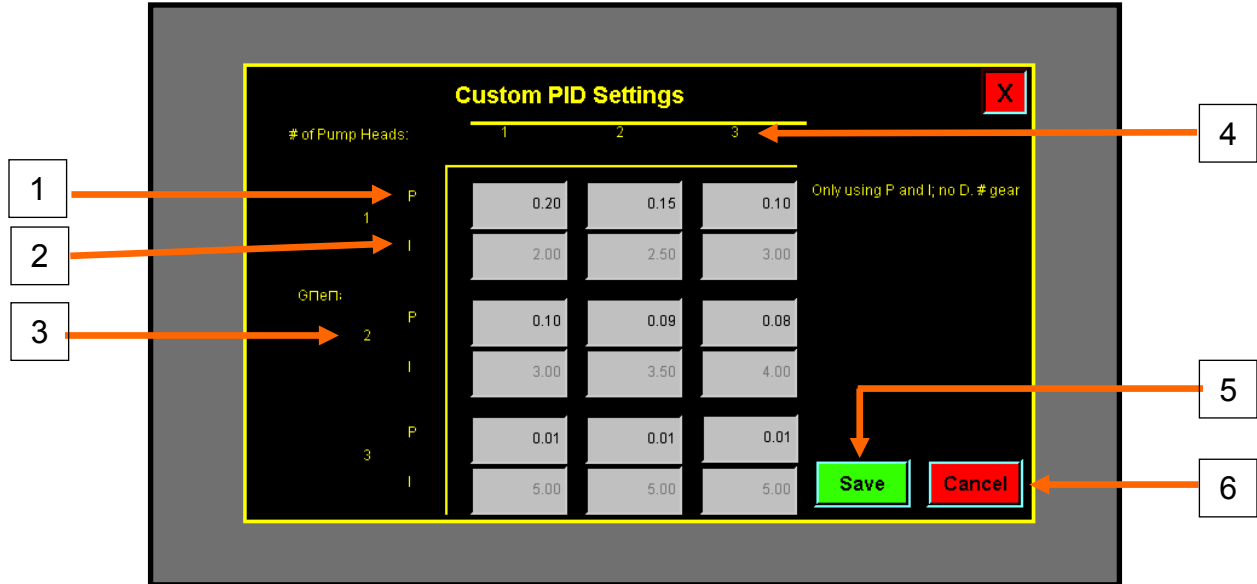

The Custom PID Pop-Up is accessible from the pump stand editing screen of the PS10 program.

1. **(P) Proportional:** The proportional portion of a PID loop controls how aggressively the motor is driven.
2. **(I) Integral:** The integral component controls how frequently the speed is updated.
3. **Pump Gear:** For USC pump stands, we also do this in a 3-gear system with first gear being our lower gear and 3rd gear being our highest gear. We setup our pump stands to drive aggressively at the start of a run and slowly shift into less aggressive gears the closer to target rate we get.
4. **Number of Pump Heads:** As we have more pump heads, the motor doesn't have to work nearly as hard so the proportional component typically gets lower for each additional pump head.
5. **Save Button:** Pressing this button will save the custom PID settings for the custom flow meter.
6. **Cancel Button:** Pressing this button closes the popup without saving any changes.

Import & Export Screens

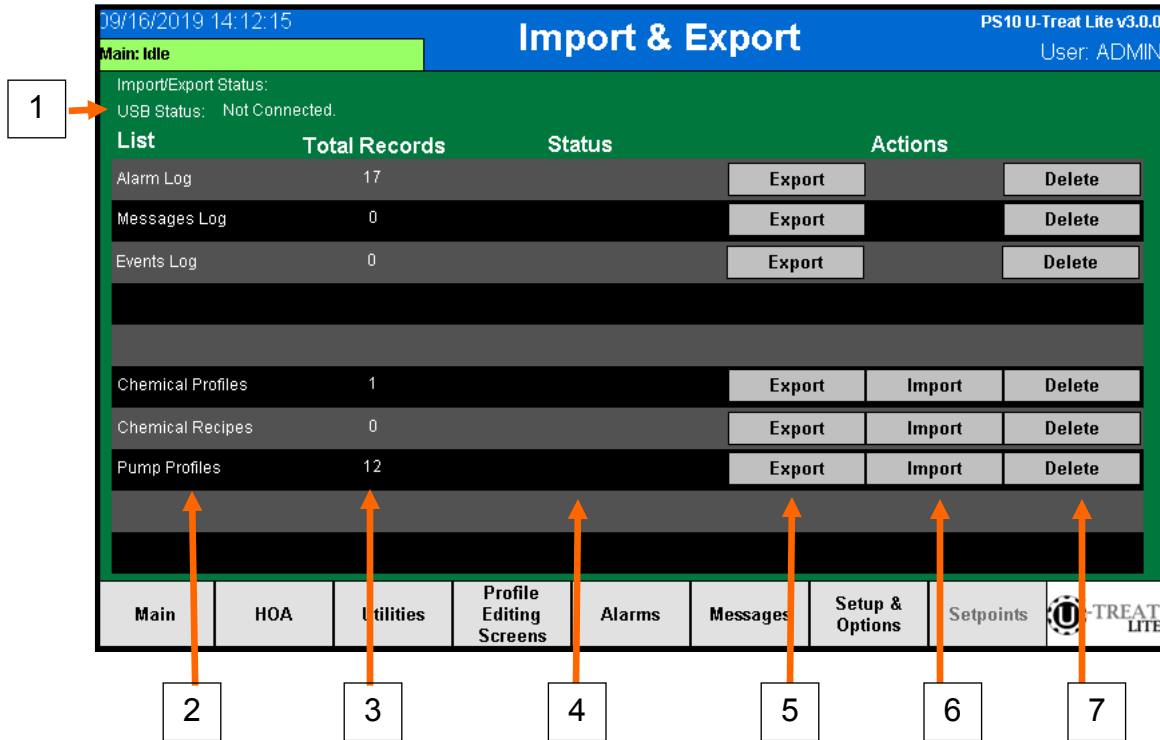

1. **USB Status:** Displays the current status of the USB device inserted into the pump stand.
2. **List Name:** Displays which profile list the row bar correlates to.
3. **Total Records:** How many records are in the in the associated profile list.
4. **Status:** Profile list's internal status. This status shows what the profile list is currently working on. If the status is blank, the list is idle and not performing any file operations.
5. **Export Buttons:** By selecting one of the export buttons, all the profiles on the associated row bar will be exported to the USB stick in the form of a CSV (Comma Separated Value). This file can be opened on another computer with software such as Microsoft Excel.
6. **Import Buttons:** By selecting one of the import buttons, all the profiles on the associated row back will be imported from the USB stick into the pump stand. This operation will overwrite any profiles already configured on the system. Not every profile allows for importing.
7. **Delete Buttons:** By selecting one of the delete buttons, all the profiles on the associated row will be deleted from the pump stand controller. New default profiles will be inserted in their place.

Alarms Screen

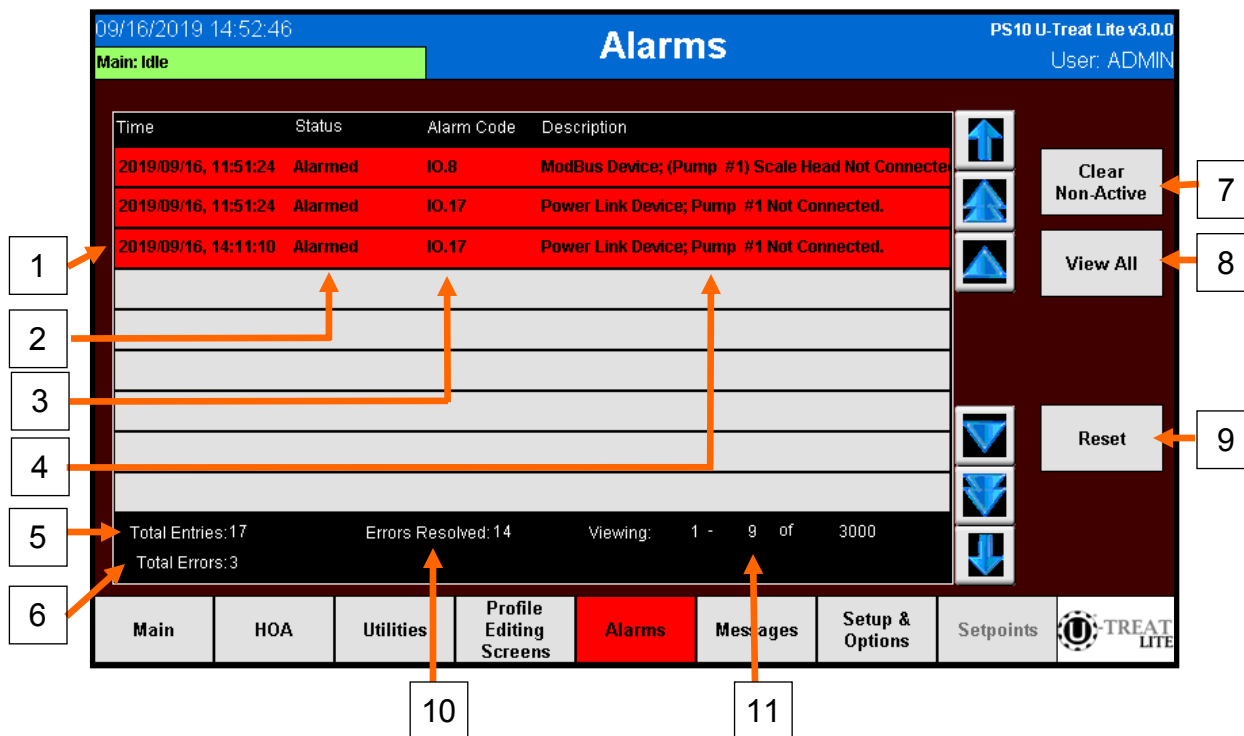

1. **Time:** This column displays the time the alarm occurred.
2. **Status:** Displays current status of the alarm. Status states are Alarmed, Silenced, Acknowledged, and Archived. Alarmed represent an alarm that is currently still active. Silenced is an alarm that is still active but not sounding off any horn (this option isn't available for this program). Acknowledged is an alarm that has been reset but still on the active list. Archived is an alarm that has been cleared off of the list active list and can be viewed in the view all list.
3. **Alarm Code:** Alarm code displays the location the alarm originated from. This will be a program tag, followed by an alarm number from that program.
4. **Description:** This field gives a brief description of the alarm.
5. **Total Entries:** Total entries shows how many entries have been logged in total. Shows the number of active and inactive logs.
6. **Total Errors:** Number of active errors that still need to be resolved.
7. **Clear Non-Active:** Clears acknowledged alarms off of the active list. These alarms then become archived and can be viewed again by selecting the View All button.
8. **View All:** Toggles between view all and hide all. Hide all will only show active alarms and hide the inactive alarms. View all shows all alarms that have occurred on the system. Shows active and archived alarms.

9. **Reset:** Resets any Alarmed or Silenced alarms. These alarms then go to a acknowledged state. If the condition of the alarm still exist, a new alarmed entry will appear.
10. **Errors Resolved:** Shows the total number of resolved or non-active errors.
11. **Viewing:** Shows what alarms of the list we are viewing. It will show the starting position of the list followed by the ending position of the list out of how many items are possible in the list.

Messages Screen

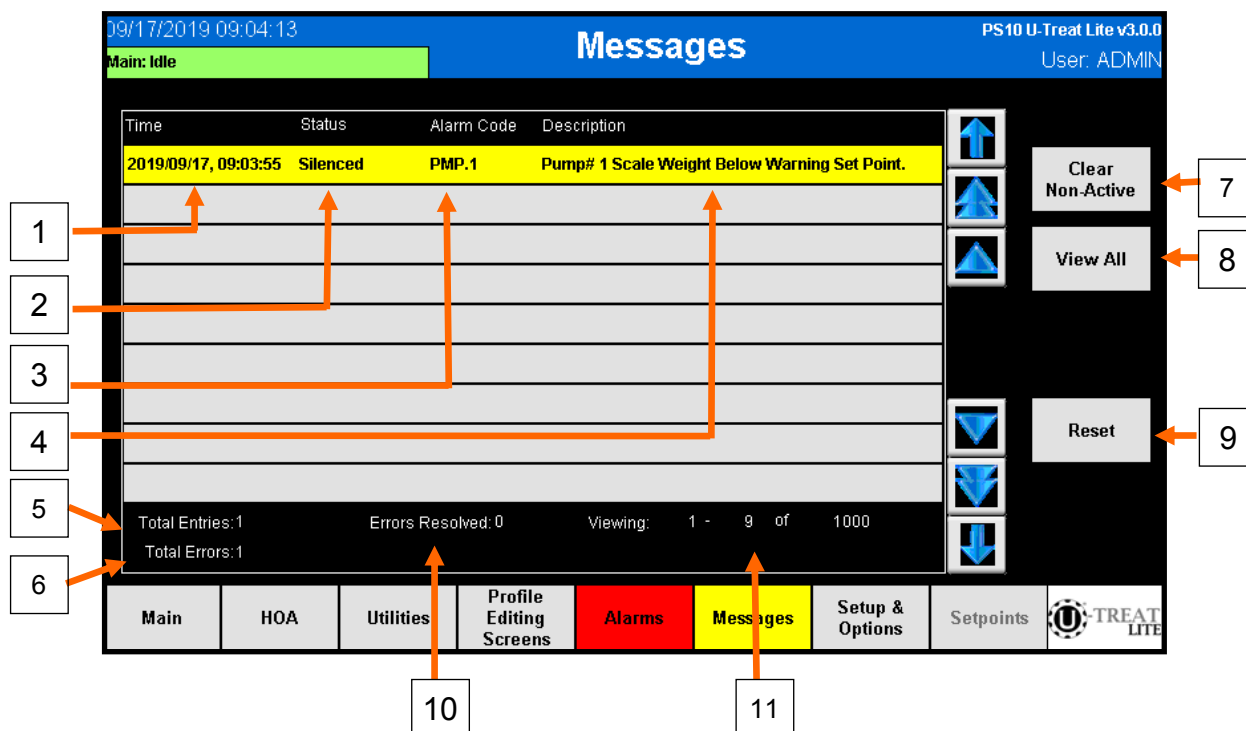

1. **Time:** This column displays the time the message occurred.
2. **Status:** Displays current status of the message. Status states are Silenced, Acknowledged, and Archived. Silenced is a message that is still active but not sounding off any horn (this option isn't available for this program). Acknowledged is a message that has been reset but still on the active list. Archived is a message that has been cleared off of the list active list and can be viewed in the view all list.
3. **Alarm Code:** Alarm code displays the location the message originated from. This will be a program tag, followed by an alarm number from that program.
4. **Description:** This field gives a brief description of the message.
5. **Total Entries:** Total entries shows how many entries have been logged in total. Shows the number of active and inactive logs.

Messages Screen

6. **Total Errors:** Number of active errors that still need to be resolved.
7. **Clear Non-Active:** Clears acknowledged messages off of the active list. These messages then become archived and can be viewed again by selecting the View All button.
8. **View All:** Toggles between view all and hide all. Hide all will only show active messages and hide the inactive messages. View all shows all messages that have occurred on the system. Shows active and archived messages.
9. **Reset:** Resets any Alarmed or Silenced messages. These messages then go to a acknowledged state. If the condition of the message still exist, a new message entry will appear.
10. **Errors Resolved:** Shows the total number of resolved or non-active errors.
11. **Viewing:** Shows what messages of the list we are viewing. It will show the starting position of the list followed by the ending position of the list out of how many items are possible in the list.

Setup & Options Screen

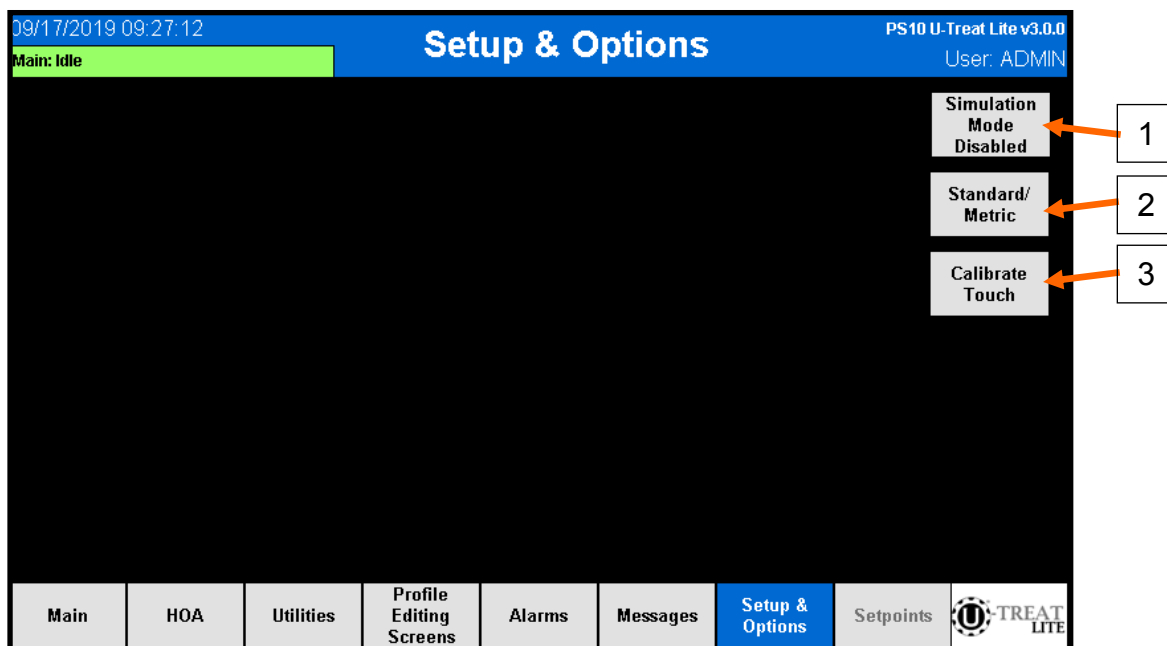

1. **Simulation Mode Button:** Turns on simulation of the pump stand panel. In simulation the pump will not start and the inputs will be simulated.
2. **Standard/Metric:** Opens the Standard / Metric pop-up.
3. **Calibrate Touch:** Allows the operator to re-calibrate the touch screen on the pump stand controller.

PUMP STANDS PS10
Setup & Options Screen

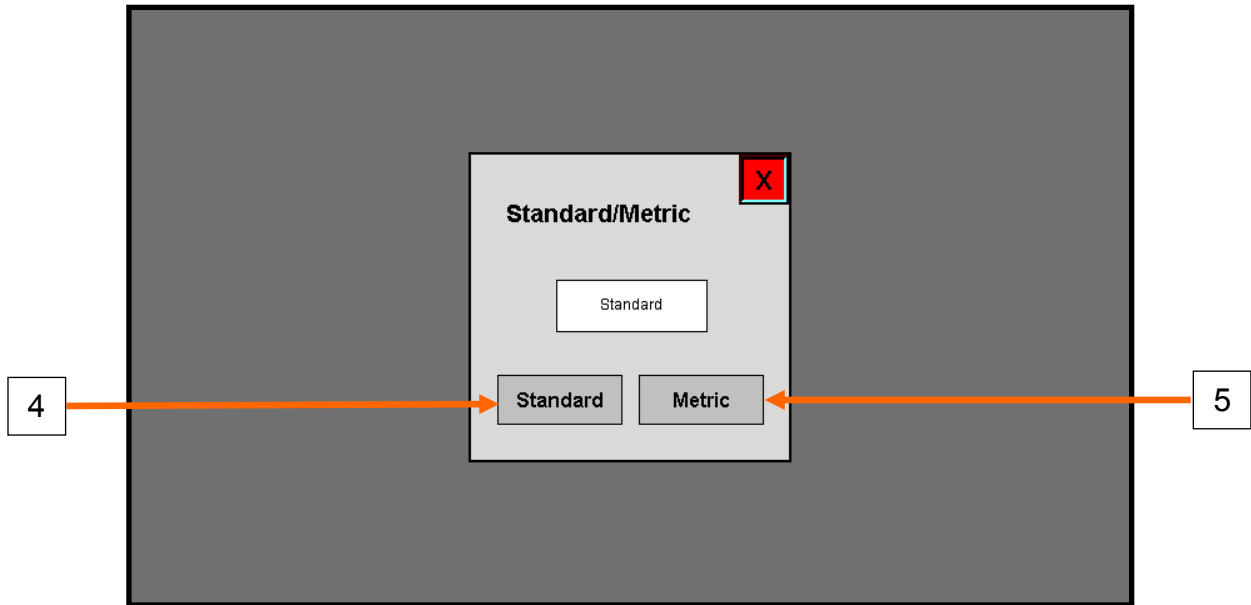

4. **Standard:** Changes the pump stand to standard unit of measurement. (Imperial—US)
5. **Metric:** Changes the pump stand to metric unit of measurement.

SECTION E TROUBLESHOOTING

Below is a table describing the most frequent problems and solutions with the Manual Pump Stand. For further assistance, contact the your local authorized dealer.

Problem	Possible Cause	Solution
Pump is fluctuating.	<ol style="list-style-type: none"> 1. Restriction in tubing 2. Filter is plugged or missing gasket. 3. Hoses are worn out. 	<ol style="list-style-type: none"> 1. Flush tubing and check filter for any restrictions. 2. Clean filter and check for gasket. 3. Replace hoses.
Pump will not turn off in AUTO when seed runs out.	<ol style="list-style-type: none"> 1. Proximity switch is dirty. 2. Proximity switch is set too sensitive. 	<ol style="list-style-type: none"> 1. Clean proximity switch. 2. Adjust the pump proximity switch sensitivity by turning adjustment screw counter-clockwise.
Pump will not turn on in AUTO.	<ol style="list-style-type: none"> 1. Proximity switch is not staying covered. 2. Proximity switch is not sensitive enough. 3. HMI screen not set to AUTO. 4. Auxiliary cable not connected. 	<ol style="list-style-type: none"> 1. Make sure proximity switch is staying covered with seed. 2. Adjust pump proximity switch sensitivity by turning the adjustment screw clockwise. 3. Set HMI screen to AUTO. 4. Attach Auxiliary cable from control panel to treater control panel.
Mix Motor will not start	<ol style="list-style-type: none"> 1. Power cord not plugged in. 	<ol style="list-style-type: none"> 1. Plug in power cord.

MAINTENANCE SECTION F

Proper maintenance of the pump stand is critical for peak performance, reliability and accuracy of this system. The following is a guideline for the type of maintenance and servicing that should be performed on this unit. Your environment and uses may require additional maintenance and service beyond this list to assure a reliable and safe unit. The operator of this unit has ultimate responsibility to identify areas of concern and rectify them before they become a hazard or safety issue. There is no substitute for a trained, alert operator.



Do not put this unit into operation with any questionably maintained parts. Poor performance or a hazard may occur.



Do not use compressed air or water under pressure to clean any of the components of the USC equipment.

MIX TANK

- Check motor.
- Check motor for any play in the mix tank shaft.
- Check valves, fittings, and plug on bottom of tank for leaks.
- Check chemical line tubing for abnormal wear.
- Wipe down the motor casing with a damp cloth making sure to remove all dust that may have collected since the last maintenance date.

PUMP STANDS WITH STANDARD MIX TANKS
PUMPS - PLUMBING - FLOW METER

1. Check pump in forward and reverse.
2. Make sure pump heads open and close smoothly.
3. Inspect tubing for uneven wear. Replace pump tubing often to ensure high flow rates can be achieved.
4. Make certain the inside of the mix tank is completely drained of chemical. Use clean water to rinse out all chemical residue, then fill the tank with clean water.
5. Disconnect the discharge process lines from the treater static mixer assembly and direct them to a receptacle large enough to hold all of the water from the mix tank.
6. Pump clean water through all areas of the plumbing including the calibration tube and flow meter if applicable. Opening and closing the valves during this process helps to remove residue from the ball valves.
7. Remove and clean the filter.
8. Open all drain points, valves, and filter to let as much of the water drain as possible.
9. Disconnect power to the flow meter.
10. If your pump stand is equipped with a volumetric flow meter, remove it from the machine for additional cleaning.
 - A. Pre - Mix a solution of 90% water and 10% distilled white vinegar.

NOTICE

Only use the vinegar and water solution mixed in these proportions to clean the flow meter. Use of any other cleaners, especially cleaners containing harsh chemicals may permanently damage the sensors and seals inside the flow meter.

PUMP STANDS WITH STANDARD MIX TANKS
PUMPS - PLUMBING - FLOW METER

- B. Use a size - matched circular brush with soft plastic bristles. Dip the brush in the solution and gently move it up and down in the measuring pipe to avoid damaging the measuring pipe and sensor electrodes.
- C. Re-peat brushing with fresh fluid until measuring pipe is visually clean.
- D. Flush the flow meter inside and out with clean water to remove any of the cleaning solution residue.



- Wipe down the motor casing with a damp cloth making sure to remove all dust that may have collected since the last maintenance date. Record the cleaning on the company required documents. If operating in a CSA 22.1, Class II, Division 2, Group G hazardous area, USC recommends this step be performed on a daily

ELECTRICAL PANEL

1. Check and tighten wire connections.
2. Check quick connects on bottom of control panel.
3. Check to see if starters and/or overloads are tripped.
4. Check to see if relays, timers and/or breakers are tripped.
5. Check quick connects on end of Auxiliary cord.
6. Check relay and fuse holder.
7. Check power cords for cuts or frays and ensure ground is present.

PUMP STANDS WITH CHEMICAL TOTES

PUMPS - PLUMBING - LIW SCALES

1. Run the pumps in reverse until all chemical has been drained from the process lines and the calibration tube back into the tote.
2. Make sure pump heads open and close smoothly.
3. Inspect tubing for uneven wear. Replace pump tubing often to ensure high flow rates can be achieved.
4. Fill two five gallon buckets with clean water. Disconnect the return line from Micro Matic valve and place it in one of the buckets. Place the Micro Matic valve in the other bucket of water.
5. Disconnect the discharge process lines from the treater static mixer assembly and direct them to a receptacle large enough to hold all of the water from the buckets.
6. Pump clean water through all areas of the plumbing including the calibration tube. Opening and closing the valves during this process helps to remove residue from the ball valves.
7. Remove and clean the filter.
8. Open all drain points, valves, and filter to let as much of the water drain as possible.
9. Wipe down the motor casing with a damp cloth making sure to remove all dust that may have collected since the last maintenance date. Record the cleaning on the company required documents.

STORAGE SECTION G

Proper Storage of the the pump stand for long periods of time is critical to reduce the chance of rust, corrosion and fatigue of the equipment. This is especially true when storing the pump stand in below freezing temperatures.

The following is a guideline for the type of cleaning and maintenance that should be performed on this unit prior to storage. Your environment and uses may require additional cleaning and preparation to assure that when the equipment is returned to production, it performs in a safe, accurate and reliable manor.



A dust mask and protective rubber gloves shall be used when cleaning the machine.

LIQUID SYSTEMS WITH STANDARD MIX TANKS

PUMPS - PLUMBING - FLOW METERS

1. Perform steps 1 through 10 on page 49 in the maintenance section to clean the chemical residue from each individual pumps stand in the system.

NOTICE

If the pump stand(s) will be exposed to possible freezing temperatures, the final flush of the system should be made with a non freezable liquid like recreational vehicle antifreeze.

2. Open all drain points, valves, and filter to let as much of the water drain as possible.
3. Release pump heads and remove tubing to prevent any unnecessary wear (see page 17).
4. If the pump stand is equipped with a volumetric flow meter, disconnect power and perform steps 10A through 10D in the maintenance section. If equipped with a mass flow meter, remove the flow meter from the pump stand and rinse with clean water.
5. Stand the flow meter upright allowing enough time for measuring pipe to air dry. After it is dry, cover both openings.

6. Store flow meters in a location with the following conditions:
 - Ambient temperature of 50 to 80 degrees Fahrenheit.
 - Protection from direct sunlight to avoid unacceptable high surface temperatures.
 - Where moisture does not collect in or on the flow meter. This will help prevent fungus or bacteria infestation which can damage the liner.
 - Store in a manner so that the inlet and outlet are as much in an up and down position as possible.
-

PUMP STANDS WITH CHEMICAL TOTES
PUMPS - PLUMBING - LIW SCALES

1. Perform steps 1 through 10 on page 48 in the maintenance section to clean the chemical residue from each individual pumps stand in the system.

NOTICE

If the pump stand(s) will be exposed to possible freezing temperatures, the final flush of the system should be made with a non freezable liquid like recreational vehicle antifreeze.

2. Open all drain points, valves, and filter to let as much of the water drain as possible.
3. Release pump heads and remove tubing to prevent any unnecessary wear (see page 17).

PUMP STANDS PS10

NOTES:

USC, LLC, (Manufacturer) warrants its seed treating equipment as follows:

1. **Limited Warranty:** Manufacturer warrants that the Products sold hereunder will be free from defects in material and workmanship for a period of 18 months from date of shipment. If the Products do not conform to this Limited Warranty during the warranty period, Buyer shall notify Manufacturer in writing of the claimed defects and demonstrate to Manufacturer satisfaction that said defects are covered by this Limited Warranty. If the defects are properly reported to Manufacturer within the warranty period, and the defects are of such type and nature as to be covered by this warranty, Manufacturer shall, at its expense, furnish replacement Products or, at Manufacturer's option, replacement parts for the defective products. Shipping and installation of the replacement Products or replacement parts shall be at the Buyer's expense.
2. **Other Limits:** THE FOREGOING IS IN LIEU OF ALL OTHER WARRANTIES, EXPRESSED OR IMPLIED, INCLUDING BUT NOT LIMITED TO THE IMPLIED WARRANTIES OF MERCHANTABILITY AND FITNESS FOR A PARTICULAR PURPOSE. Manufacturer does not warrant against damages or defects arising from improper installation (where installation is by persons other than Manufacturer), against defects in products or components not manufactured by Manufacturer, or against damages resulting from such non-Manufacturer made products or components. Manufacturer passes on to the Buyer the warranty it received (if any) from the maker of such non-Manufacturer made products or components. This warranty also does not apply to Products upon which repairs and / or modifications have been effected or attempted by persons other than pursuant to written authorization by Manufacturer. This includes any welding on equipment which could damage electrical components. Manufacturer does not warrant against casualties or damages resulting from misuse and / or abuse of Products, improper storage or handling, acts of nature, effects of weather, including effects of weather due to outside storage, accidents, or damages incurred during transportation by common carrier.
3. **Exclusive Obligation:** THIS WARRANTY IS EXCLUSIVE. The sole and exclusive obligation of Manufacturer shall be to repair or replace the defective Products in the manner and for the period provided above. Manufacturer shall not have any other obligation with respect to the Products or any part thereof, whether based on contract, tort, strict liability or otherwise. Under no circumstances, whether based on this Limited Warranty or otherwise, shall Manufacturer be liable for lost profits, lost revenue, lost sales (whether direct or indirect damages), incidental, special, punitive, indirect or consequential damages.
4. **Other Statements:** Manufacturer's employees or representatives' oral or other written statements do not constitute warranties, shall not be relied upon by Buyer, and are not a part of the contract for sale or this limited warranty.
5. **Return Policy:** Approval is required prior to returning goods to Manufacturer. A restocking fee will apply.
6. **Entire Obligation:** This Limited Warranty states the entire obligation of Manufacturer with respect to the Products. If any part of this Limited Warranty is determined to be void or illegal, the remainder shall remain in full force and effect.

US / Canada Non-Exclusive 2016

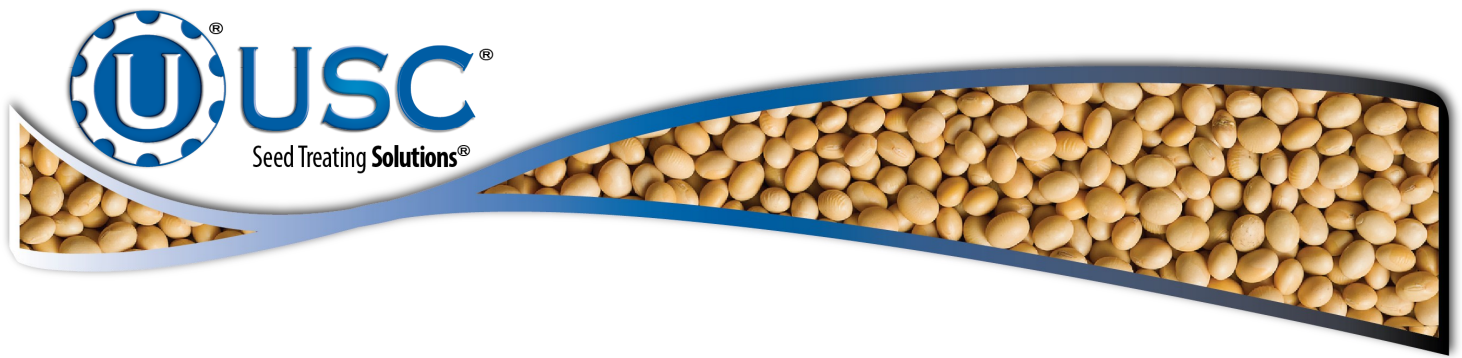

USC, LLC

2320 124th road

Sabetha, KS 66534

(785) 431-7900

EMAIL: sales-team@uscllc.com

WEB: www.uscllc.com

