

LP MASS FLOW METER

Operators Manual



Document: TD-09-06-3002

Revision: A



INTRODUCTION

Thank you for choosing USC, LLC for your equipment needs. We appreciate your business and will work diligently to ensure that you are satisfied with your choice.

OVERVIEW

The purpose of this manual is to provide you with the basic information needed to operate and maintain the LP Mass Flow Meter. It does not hold USC, LLC liable for any accidents or injuries that may occur.

The technical information provided in this document is based on extensive testing under controlled conditions at the USC research and development facility. This information is given without guarantee as the conditions of operation and storage of the equipment are beyond our control. Variables such as temperature, humidity, viscosity of chemical products and changes in seed size or variety may all effect the accuracy of application and seed coverage. Periodically check the equipment calibration while treating and make adjustments as required. This will insure the optimum seed coverage.

OPERATOR RESPONSIBILITIES

As the purchaser/owner/operator of this equipment and control system, you have an obligation to install, operate, and maintain the equipment in a manner that minimizes the exposure of people in your care to any potential hazards inherent in using this equipment. It is critical that the owner of this equipment:

- Has a clear and documented understanding of the process this machine is being used in and of any resulting hazards or special requirements arising from this specific application.
- Allow only properly trained and instructed personnel to install, operate or service this equipment.
- Maintain a comprehensive safety program involving all who work with this machine and other associated process equipment.
- Establish clear areas of staff responsibility (e.g. operation, setup, sanitation, maintenance, and repairs).
- Provide all personnel with necessary safety equipment.
- Periodically inspect the equipment to insure that the doors, covers, guards, and safety devices are in place and functioning, that all safety instructions and warning labels are intact and legible, and that the equipment is in good working order.
- In addition to the operating instructions, observe and enforce the applicable legal and other binding regulations, national and local codes.

LP MASS FLOW METER

As the person with the most to gain or lose from working safely, it is important that you work responsibly and stay alert. By following a few simple rules, you can prevent an accident that could injure or kill you or a co-worker.

- Disconnect, lockout, and tagout electrical and all other energy sources before inspecting, cleaning, servicing, repairing, or any other activity that would expose you to the hazards of electrical shock.
- Do not operate, clean, or service this equipment until you have read and understood the contents of this manual. If you do not understand the information in this manual, bring it to the attention of your supervisor, or call USC at (785) 431-7900 for assistance.
- Any operator who is known or suspected to be under the influence of alcohol or drugs should not be allowed to operate the equipment.
- Understand and follow the safety practices required by your employer and this manual.
- **PAY ATTENTION** to what you and other personnel are doing and how these activities may affect your safety.
- **Failure to follow these instructions may result in serious personal injury or death.**

RECEIVING YOUR EQUIPMENT

As soon as the equipment is received, it should be carefully inspected to make certain that it has sustained no damage during shipment and that all items listed on the packing list are accounted for. If there is any damage or shortages, the purchaser must immediately notify USC, LLC. Ownership passes to purchaser when the unit leaves the USC, LLC. premises. The purchaser is responsible for unloading and mounting all components of the equipment.

For a complete list of items shipped with this kit, see the exploded drawing view and parts list on pages 26 and 27.

TABLE OF CONTENTS

<u>Section</u>	<u>Contents</u>	<u>Page #</u>
Section A	Safety Instructions	5
Section B	Installation	12
Section C	Operating Instructions.....	17
Section D	Calibration	18
	Pump Calibration with Flow Meter	18
	Flow Meter Calibration	19
	Using the Flow Meter Calibration Sheet	21
Section E	Troubleshooting	23
Section F	Maintenance & Storage.....	24
Section G	Mechanical Drawings.....	26
Section H	Limited Warranty	29

SAFETY INSTRUCTIONS

SECTION A

Every year accidents in the work place maim, kill and injure people. Although it may be impossible to prevent all accidents, with the right combination of training, operating practices, safety devices, and operator vigilance, the number of accidents can be significantly reduced. The purpose of this section is to educate equipment users about hazards, unsafe practices, and recommended hazard avoidance techniques.

SAFETY WORDS AND SYMBOLS

It is very important that operators and maintenance personnel understand the words and symbols that are used to communicate safety information. Safety words, their meaning and format, have been standardized for U.S. manufacturers and published by the American National Standards Institute (ANSI). The European Community (E.C.) has adopted a different format based on the International Standards Organization (I.S.O.) and applicable machinery directives. Both formats are presented below. Graphic symbols are not standardized, but most manufacturers will use some variation of the ones seen in this manual.



Indicates an imminently hazardous situation which, if not avoided, **will** result in death or serious injury.



Indicates a potentially hazardous situation which, if not avoided, **could** result in death or serious injury.



Indicates a potentially hazardous situation which, if not avoided, **may** result in minor or moderate injury and/or property damage.



Provides additional information that the operator needs to be aware of to avoid a potentially hazardous situation.



Mandatory Lockout Power Symbol. Disconnect, lockout and tagout electrical and other energy sources before inspecting, cleaning or performing maintenance on this panel.



International Safety Alert Symbol. The exclamation point (!) surrounded by a yellow triangle indicates that an injury hazard exists. However, it does not indicate the seriousness of potential injury. The exclamation point (!) is also used with the DANGER, WARNING and CAUTION symbols so the potential injury is indicated.



Electrocution Hazard Symbol. This symbol indicates that an electrocution hazard exists. Serious injury or death could result from contacting high voltage.



International Electrocution Hazard. This symbol indicates that an electrocution hazard exists. Serious injury or death could result from contacting high voltage.



Mandatory Read Manual Action Symbol. (I.S.O. format) This symbol instructs personnel to read the Operators Manual before servicing or operating the equipment.



Mandatory Read Manual Action Symbol. This symbol instructs personnel to read the Operators Manual before servicing or operating the equipment.



Notice is used to notify people of important installation, operation or maintenance information which is not hazard related.

LOCKOUT / TAGOUT PROCEDURES

Lockout/Tagout is the placement of a lock/tag on an energy isolating device in accordance with an established procedure. When taking equipment out of service to perform maintenance or repair work, always follow the lockout/tagout procedures as outlined in ANSI Z344.1 and/or OSHA Standard 1910.147. This standard “requires employers to establish a program and utilize procedures for affixing appropriate lockout devices or tagout devices to energy isolating devices and to otherwise disable machines or equipment to prevent unexpected energizing, start-up, or release of stored energy in order to prevent injury to employees.”

HAZARD REVIEW

Electrocution Hazard



Electrocution accidents are most likely to occur during maintenance of the electrical system or when working on or near exposed high voltage wiring. This hazard does not exist when the electrical power has been disconnected, properly locked, and tagged out.

Automatic Start Hazard



The equipment may be controlled by an automated system and may start without warning. Failure to properly disconnect, lockout, and tagout all energy sources of remotely controlled equipment creates a very hazardous situation and could cause injury or even death. PLEASE STAY CLEAR AND BE ALERT.

YOU are responsible for the **SAFE** operation and maintenance of your USC, LLC equipment . **YOU** must ensure that you and anyone else who is going to operate, maintain, or work around the treater be familiar with the operating and maintenance procedures and related **SAFETY** information contained in this manual. This manual will take you step-by-step through your working day and alert you to good safety practices that should be adhered to while operating the treater.

Remember, **YOU** are the key to safety. Good safety practices not only protect you, but also the people around you. Make these practices a working part of your safety program. Be certain that **EVERYONE** operating this equipment is familiar with the recommended operating and maintenance procedures and follows all the safety precautions. Most accidents can be prevented. Do not risk injury or death by ignoring good safety practices.

- Equipment owners must give operating instructions to operators or employees before allowing them to operate the machine, and at least annually thereafter per OSHA (Occupational Safety and Health Administration) regulation 1928.57.
- The most important safety device on this equipment is a **SAFE** operator. It is the operator's responsibility to read and understand **ALL** Safety and Operating instructions in the manual and to follow them. All accidents can be avoided.
- A person who has not read and understood all operating and safety instructions is not qualified to operate the machine. An untrained operator exposes himself and bystanders to possible serious injury or death.
- Do not modify the equipment in any way. Unauthorized modification may impair the function and/or safety and could affect the life of the equipment.
- Think SAFETY! Work SAFELY!

GENERAL SAFETY

1. Read and understand the Operator's Manual and all safety labels before operating, maintaining, adjusting or unplugging the seed treater .
2. Only trained persons shall operate the seed treater. An untrained operator is not qualified to operate the machine.
3. Have a first-aid kit available for use should the need arise, and know how to use it.



LP MASS FLOW METER

4. Provide a fire extinguisher for use in case of an accident. Store in a highly visible place.
5. Do not allow children, spectators or bystanders within hazard area of machine.
6. Wear appropriate protective gear. This includes but is not limited to:
 - A hard hat
 - Protective shoes with slip resistant soles
 - Protective goggles
 - Heavy gloves
 - Hearing protection
 - Respirator or filter mask
7. Place all controls in neutral or off, stop motor, and wait for all moving parts to stop. Then disable power source before servicing, adjusting, repairing, or unplugging.
8. Review safety related items annually with all personnel who will be operating or maintaining the Equipment.



OPERATING SAFETY:

1. Read and understand the Operator's Manual and all safety labels before using.
2. Disconnect and disable electrical supply completely and wait for all moving parts to stop before servicing, adjusting, repairing or unplugging.
3. Clear the area of bystanders, especially children, before starting.
4. Be familiar with the machine hazard area. If anyone enters hazard area, shut down machine immediately. Clear the area before restarting.
5. Keep hands, feet, hair and clothing away from all moving and/or rotating parts.
6. Stay away from overhead obstructions and power lines during operation and transporting. Electrocutation can occur without direct contact.
7. Do not operate machine when any guards are removed.
8. Inspect welds and repair if needed.

PLACEMENT SAFETY

1. Move only with the appropriate equipment
2. Stay away from overhead power lines when moving the treater. Electrocution can occur without direct contact.
3. Be familiar with machine hazard area. If anyone enters hazard areas, shut down machine immediately. Clear the area before restarting.
4. Operate the treater on level ground free of debris. Anchor the treater to prevent tipping or upending.



Before placement of the pump stand, be sure that ground is reasonably level. The pump stand may topple or work improperly if the ground is too uneven, damaging the equipment and/or causing personal injury.

MAINTENANCE SAFETY

1. Review the Operator's Manual and all safety items before working with, maintaining or operating the Equipment .
2. Place all controls in neutral or off, stop motors, disable power source, and wait for all moving parts to stop before servicing, adjusting, repairing or unplugging.
3. Follow good shop practices:
Keep service area clean and dry.
Be sure electrical outlets and tools are properly grounded.
Use adequate light for the job at hand.
4. Keep hands, feet, hair and clothing away from all moving and/or rotating parts.
5. Clear the area of bystanders, especially children, when carrying out any maintenance and repairs or making any adjustments.
6. Before resuming work, install and secure all guards when maintenance work is completed.
7. Keep safety labels clean. Replace any sign that is damaged or not clearly visible.



SAFETY LABELS

1. Keep safety labels clean and legible at all times.
2. Replace safety labels that are missing or have become illegible.
3. Replaced parts that displayed a safety sign should also display the current sign.
4. Replacement safety labels are available. Contact USC at (785) 431-7900 .

How to Install Safety Labels:

- Be sure that the installation area is clean and dry.
- Be sure temperature is above 50°F (10°C).
- Decide on the exact position before you remove the backing paper.
- Remove the smallest portion of the split backing paper.
- Align the sign over the specified area and carefully press the small portion with the exposed sticky backing in place.
- Slowly peel back the remaining paper and carefully smooth the remaining portion of the sign in place.
- Small air pockets can be pierced with a pin and smoothed out using the piece of sign backing paper.



Located on the USC equipment you will find safety labels. Always be sure to read and follow all directions on the labels.



Guards provided with USC equipment are to remain in place during operation.

**SECTION
B**

INSTALLATION

MOUNTING FLOW METER

USC, LLC recommends mounting the flow meter on the right-hand side of the seed treater.

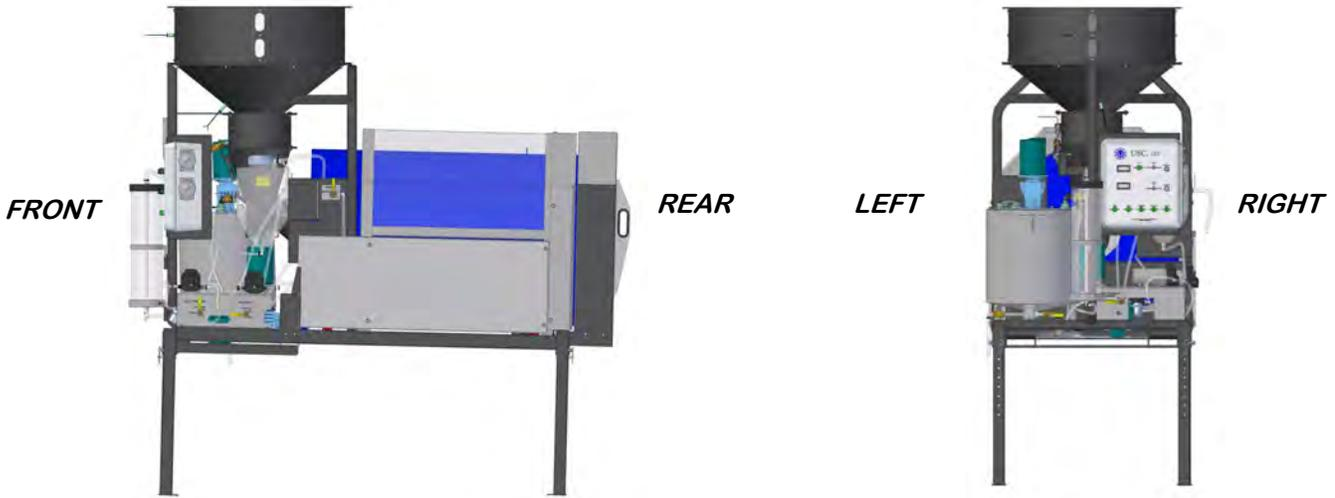

MOUNTING FLOW METER TO STATIONARY OR PORTABLE LP-SERIES SEED TREATER

1. Remove the back chain guard bolt on the right side of the treater (if applicable) and mount the flow meter bracket with one of the mounting holes. Leave the bolt hand tight. If the bolt hole does not exist, drill a 5/16 inches hole and tap to 3/8 inch.
2. Line up the other mounting hole on the frame of the treater. Drill a 5/16 inch hole and tap to 3/8 inch. Using the 3/8 inch bolt provided, tighten the flow meter bracket to the frame of the seed treater. The two mounting holes are approximately 12.5 inches apart.

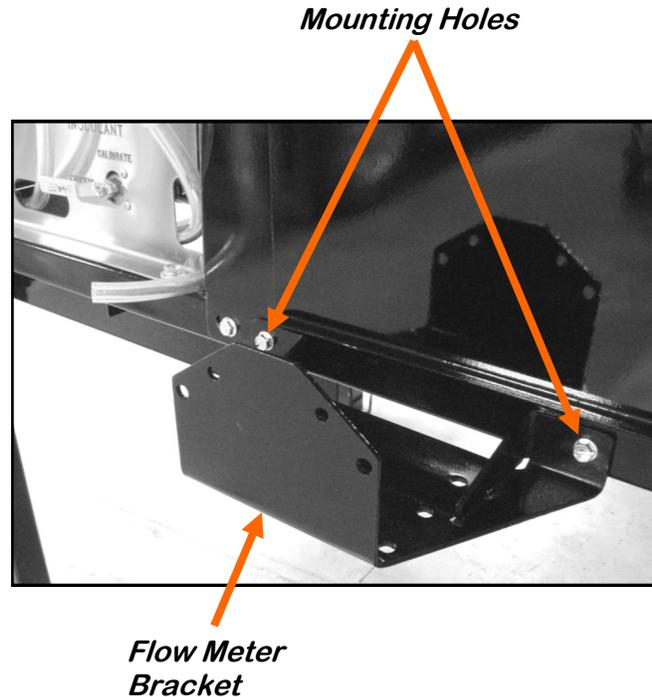

MOUNTING FLOW METER

5. Unclamp the Pump #1 pump tubing from the hose connecting to the SEED TREATMENT valve.
6. Connect a piece of tubing from the Pump #1 pump tubing to the flow meter inlet. Leave enough of the clear tubing to allow the pump tubing to be fully used.
7. Connect a piece of tubing from the SEED TREATMENT valve to the flow meter outlet.

NOTICE Cut off any excess tubing. This will allow for easier clean-up and better accuracy.

8. Hook the flow meter cord to the receptacle. The receptacle will need to be mounted into the seed treater control panel. Refer to page 16 for wiring instructions.
9. Turn power on to the flow meter. The meter will go through several start-up parameters before advancing to the main flow display screen.

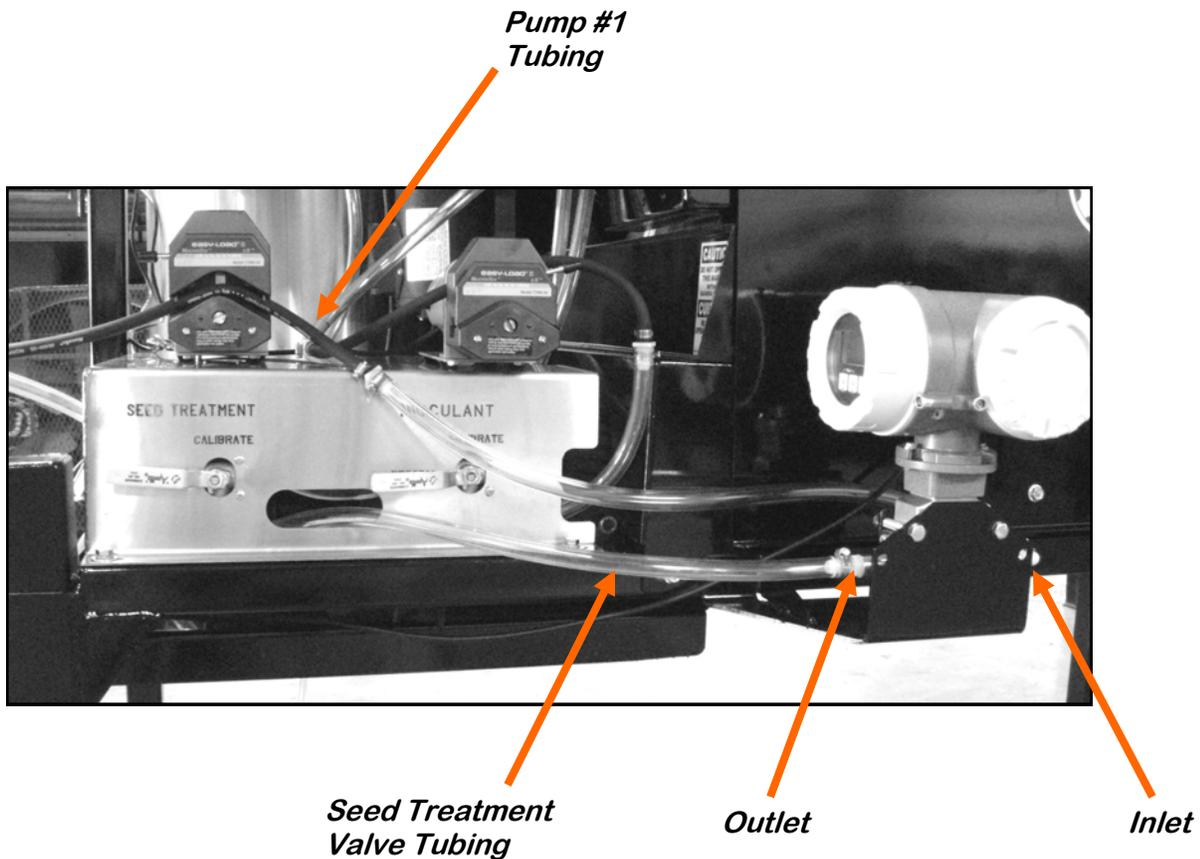

MOUNTING FLOW METER

10. On the right side of the treater main control panel bracket, drill a 3/8 inch hole for mounting the flow meter panel and bracket.



1 1/2"

11. Use a 3/8 inch flange bolt and flange nut to mount the flow meter panel bracket to the main treater control panel bracket. Place the flow meter bracket on the inside of the LP panel bracket and tighten the bolt and nut.

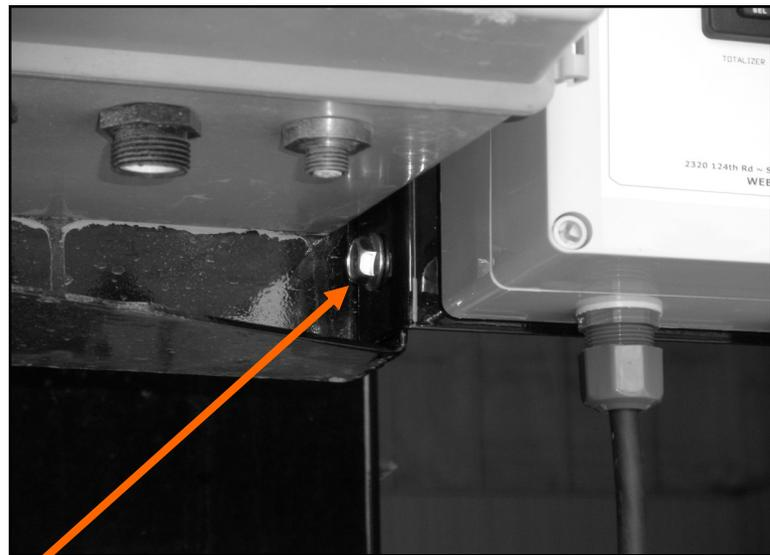

Secure panel mounting bracket with a 3/8 inch flange bolt and nut here.

LP MASS FLOW METER

MOUNTING FLOW METER



12. Attach the power and communications cables from the flow meter control panel to the flow meter using cable grips and provided schematic.

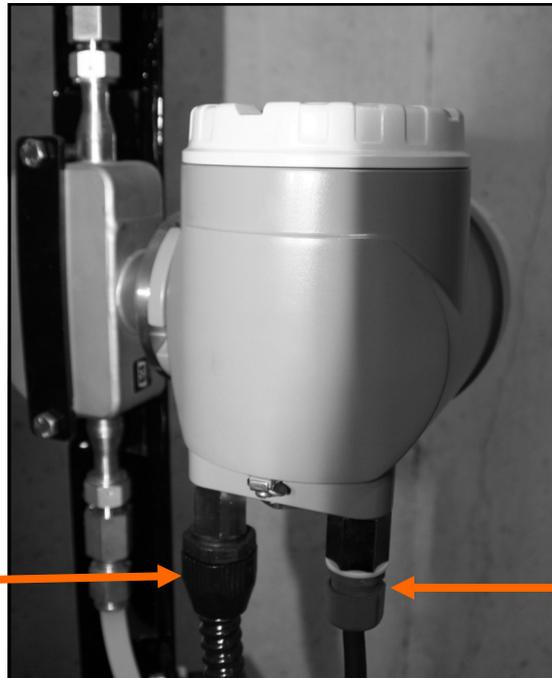

Communications cable from the control panel

Power cable from the control panel

13. Plug in the power cord from the flow meter panel. The meter and display will go through several start-up parameters before advancing to the main flow display screen.

OPERATING INSTRUCTIONS

SECTION C

The LPX Mass flow meter displays in ounces per minute and the flow meter panel display is programmed to read total ounces and ounces per minute. Metric units may also be displayed if specified during ordering. If you want the display to read in metric and you have already received the flow meter, contact USC customer service for a copy of the Red Lion Cub 5 Programming Guide and re-program the display for metric. The flow meter sends a signal to the flow meter display on the front of the flow meter control panel where the signal is converted to either ounces per minute and total ounces or millimeters per minute and total millimeters.

Ounces per minute (oz/min) and total ounces can both be displayed on the same screen of the LPX Mass flow meter display. To cycle between the totalizer and ounces per minute display, simply press the SEL button on the bottom left of the display. To ZERO out the total ounces used, you simply push the RST button located on the bottom right side of the flow meter display while viewing the totalizer screen.

Flow Rate/Totalizer

This display shows either the total ounces of chemical that has been run or the current rate of flow through the flow meter depending on which display is currently selected.



Select Key

This button allows the operator to move between the flow rate and totalizer displays.

Reset Key

This button allows the operator to reset the totalizer.

SECTION
D**CALIBRATION****PUMP CALIBRATION WITH FLOW METER**

The following steps illustrate how to calibrate a pump with a flow meter on an LP series seed treater.

1. Lock down the pump tubing in the pump head.
2. Premix enough liquid for the amount of seed you are treating and pour into the 27 gallon stainless steel tank. It's always a good practice to mix up 20% extra slurry to help fill all the lines. Turn on the mix tank and allow liquid to mix.
3. Turn the SEED TREATMENT SOURCE valve to the MIX TANK position, the SEED TREATMENT valve to the CALIBRATE position and, the valve on top of the mix tank to MIX TANK.
4. Place the pump direction switch to FORWARD.
5. Turn the HAND / OFF / AUTO switch to the Hand position and set the Pump #1 liquid adjust dial (right) to about 500 or half speed. The liquid should begin re-circulating from the bottom of the mix tank, through the pump, and back into the top of the mix tank.
6. Allow pump to re-circulate liquid for approximately 15 minutes to ensure all air has been removed from the liquid lines. This will also help break-in the pump tubing, which is critical before checking pump calibration.
7. After you have allowed the liquid to re-circulate you are ready to calibrate the liquid flow. Determine the number of ounces needed in one minute.



EXAMPLE: The seed treatment slurry rate is 5 ounces per cwt.
 Seed Flow Rate = 10.8 cwt/min. x 5 oz./cwt. = 54 oz./min.
 54 oz. is the rate the pump should be pumping in one minute.

8. Set the Liquid Flow Rate using the Liquid Adj. dial. Increase or decrease the pump speed until the liquid flow rate has been matched. An R will display on the left side of the screen when in flow rate mode.
9. Once the flow rate is set you can begin the seed treating process. The flow rate can still be adjusted during the treating process.

FLOW METER CALIBRATION

The following steps illustrate how to calibrate a flow meter on an LP series seed treater. You will need a stopwatch for this calibration.

1. Determine a desired flow rate.

EXAMPLE: The seed treatment slurry rate is 5 ounces per cwt.
Seed Flow Rate = 10.8 cwt/min. x 5 oz./cwt. = 54 oz./min.
54 oz. is the rate the pump should be pumping in one minute.

2. Set the Liquid Flow Rate using the Liquid Adj. dial. Increase or decrease the pump speed until the liquid flow rate has been matched.
3. Begin the calibration process by pumping chemical into the calibration tube and using the stop watch to start timing once the liquid reaches the zero mark on the calibration tube.
4. Note the rate that the flow meter is currently reading

EXAMPLE: Flow meter reading = 54 Oz./min

5. After approximately one minute, simultaneously stop timing and shut down the flow of liquid to the calibration tube.
6. Note the total ounces of liquid in the calibration tube and the total amount of time that it took to fill the tube to that level in seconds. Divide those two numbers to find the ounces per second (Oz./Sec) of liquid application rate. Now multiply the ounces per second of liquid application rate by 60 to get the ounces per minute (Oz./Min) liquid application rate. This number is the actual amount of ounces per minute that the pump is currently pumping.

EXAMPLE: Total ounces of liquid in the calibration tube = 57 ounces.
Total amount of time to fill calibration tube = 62 seconds.
Oz./Sec liquid application rate = 57 ounces / 62 seconds = 0.9194
Oz./Min liquid application rate = 0.9194 x 60 seconds = 55.16
The actual liquid application rate is 55.16 Oz./min

7. Take the flow meter reading that was previously noted and divide it by the actual liquid application rate. This number will give you the calibration factor that the flow meter reading will need to be adjusted by.

EXAMPLE: Flow meter reading = 54 Oz./min
Actual liquid application rate = 55.16 Oz./min
Calibration factor = $54 / 55.16 = 0.9790$

The calibration factor is 0.9790

8. In order to find the flow meter reading that is needed for accurate application of the liquid, you must now multiply the calibration factor by the desired application rate.

EXAMPLE: Calibration factor = 0.9790
Desired flow rate = 54 Oz./min
Flow meter reading for accurate application = $0.9790 \times 54 = 52.87$

52.87 Oz./min is the rate that the flow meter should read to ensure proper flow is being achieved.

9. Now you can set the pump dial so that the flow meter will read the rate that is needed to ensure the accurate flow of liquids being applied to the seed.

USING THE FLOW METER CALIBRATION WORKSHEET

The following steps illustrate how to use the flow meter calibration worksheet found on the USB stick (08-09-0143) included with this kit. This excel sheet may also be downloaded from the USC website at www.uscllc.com. From the main page select the Service tab, Technical Library, Calibration Spreadsheets and then choose Flow Meter.

The name of the excel spreadsheet is **Flow Meter Calibration Sheet.xlsx**. The worksheet will simplify the calibration of the flow meter. Below is a screen shoot of the actual worksheet. You will need a stop watch to complete this calibration.

FLOW METER CALIBRATION SHEET

Step #1: Turn the system on and let the pump run with the appropriate chemical flowing through it in recirculation mode for 15 minutes.
 Step #2: Begin pumping chemical into the calibration tube and start timing the flow when liquid reaches the zero mark. Note the rate that the flow meter is reading.
 Step #3: At approximately one minute, shut the flow off to the calibration tube and note the total ounces in the calibration tube.
 Step #4: Enter in the total ounces in the calibration tube into the space below the "Actual Amount Applied (Oz.)" box. (Arrow #1)
 Step #5: Enter in the total amount of seconds it took to fill the calibration tube into the space below the "Time To Apply (Seconds)" box. (Arrow #2)
 Step #6: At this point, the spreadsheet will automatically populate the "Oz./Min Applied" box. (Arrow #3)
 Step #7: Enter the previously noted flow meter reading into the space below the "Flow Meter Reading (Oz./Min)" box. (Arrow #4)
 Step #8: At this point, the spreadsheet will automatically populate the "Calibration Factor" box. (Arrow #5)
 Step #9: Enter in the appropriate rate that the operator wishes to treat at into the space below the "Desired Application Rate (Oz./Min)" box. (Arrow #6)
 Step #10: The spreadsheet will then populate the "Flow Meter Rate Needed For Accurate Application (Oz./Min)" box. (Arrow #7)
 Step #11: The operator can now use this final number (red number) for his target rate on the flow meter display in order to reach the desired application rate.

Actual Amount Applied (Oz.)	Time To Apply (Seconds)	Oz./Min Applied	Flow Meter Reading (Oz./Min)	Calibration Factor	Desired Application Rate (Oz./Min)	Flow Meter Rate Needed for Accurate Application (Oz./Min)
↓	↓	↓	↓	↓	↓	↓
		####		####		#DIV/0!

1. Allow pump to re-circulate liquid for approximately 15 minutes to ensure all air has been removed from the liquid lines. This will also help break-in the pump tubing, which is critical before checking flow meter calibration.
2. Begin pumping chemical into the calibration tube and start timing the flow when liquid reaches the zero mark. Note the rate that the flow meter is reading.
3. At approximately one minute, shut the flow off to the calibration tube and note the total ounces in the calibration tube.
4. Enter in the total ounces in the calibration tube into the space below the Actual Amount Applied (Oz.) box. (Arrow #1) **EXAMPLE: 35**

Actual Amount Applied (Oz.)	Time To Apply (Seconds)	Oz./Min Applied	Flow Meter Reading (Oz./Min)	Calibration Factor	Desired Application Rate (Oz./Min)	Flow Meter Rate Needed for Accurate Application (Oz./Min)
↓	↓	↓	↓	↓	↓	↓
35		####		####		#VALUE!

LP MASS FLOW METER

5. Enter in the total amount of seconds it took to fill the calibration tube into the space below the Time To Apply (Seconds) box. (Arrow #2) **EXAMPLE: 65**
6. At this point, the spreadsheet will automatically populate the Oz./Min Applied box. (Arrow #3) **EXAMPLE: 32.3**

Actual Amount Applied (Oz.)	Time To Apply (Seconds)	Oz./Min Applied	Flow Meter Reading (Oz./Min)	Calibration Factor	Desired Application Rate (Oz./Min)	Flow Meter Rate Needed for Accurate Application (Oz./Min)
35	65	32.3		0		0

7. Enter the previously noted flow meter reading into the space below the Flow Meter Reading (Oz./Min) box. (Arrow #4) **EXAMPLE: 30**
8. At this point, the spreadsheet will automatically populate the Calibration Factor box. (Arrow #5) **EXAMPLE: 0.93**

Actual Amount Applied (Oz.)	Time To Apply (Seconds)	Oz./Min Applied	Flow Meter Reading (Oz./Min)	Calibration Factor	Desired Application Rate (Oz./Min)	Flow Meter Rate Needed for Accurate Application (Oz./Min)
35	65	32.3	30	0.93		0

9. Enter in the appropriate rate that the operator wishes to treat at into the space below the Desired Application Rate (Oz./Min) box. (Arrow #6) **EXAMPLE: 30**
10. The spreadsheet will then populate the Flow Meter Rate Needed For Accurate Application (Oz./Min) box. (Arrow #7) **EXAMPLE: 27.86**
11. The operator may now use this final number (red number) for his target rate on the flow meter display in order to reach the desired application rate. **EXAMPLE: 27.86**

Actual Amount Applied (Oz.)	Time To Apply (Seconds)	Oz./Min Applied	Flow Meter Reading (Oz./Min)	Calibration Factor	Desired Application Rate (Oz./Min)	Flow Meter Rate Needed for Accurate Application (Oz./Min)
35	65	32.3	30	0.93	30	27.86

TROUBLESHOOTING **SECTION
E**

Below is a table describing the most frequent problems and solutions with the LP Mass Flow Meter. For further assistance, contact USC at (785) 431-7900.

Problem	Possible Cause	Solution
Flow Meter is fluctuating	<ol style="list-style-type: none"> 1. Pump is sucking air. 2. Restriction in the line. 3. Flow meter is not full of liquid 	<ol style="list-style-type: none"> 1. Check and tighten all hose connections. 1. Check filter to see if gasket is missing or cracked. 2. Clean out filter and lines to check for any debris. 3. The meter will fluctuate if there is nothing pumping and there is some liquid left in the meter. Drain out liquid.
Flow meter won't turn on	<ol style="list-style-type: none"> 1. Improper power going to flow meter. 2. Loose connection. 	<ol style="list-style-type: none"> 1. Check incoming power to flow meter. 2. Check connections inside the control panel and inside the flow meter.
Flow Meter is reading too low or too high.	<ol style="list-style-type: none"> 1. Restriction in Flow Meter or in line. 2. Air in treatment. This can cause the flow meter to read lower than calibrating it using a measuring cup. 3. Seed flow has changed. 	<ol style="list-style-type: none"> 1. Flush the flow meter with water or use compressed air and blow air backwards through the meter. 2. Check and tighten all hose connections. 2. Check filter to see if gasket is missing or cracked. 3. Recheck seed flow rate.
Flow meter will not zero	<ol style="list-style-type: none"> 1. Improper wiring 2. Wrong parameter programmed into flow meter 	<ol style="list-style-type: none"> 1. Check wiring schematic. 2. Check flow meter parameters. Call local dealer.

**SECTION
F****MAINTENANCE & STORAGE**

Proper maintenance and storage of the flow meter is critical for peak performance, reliability and accuracy of this system. The following is a guideline for the type of maintenance and storage procedure that should be followed. Your environment and uses may require additional maintenance and service beyond this list to assure a reliable and safe unit. The operator of this unit has ultimate responsibility to identify areas of concern and rectify them before they become a hazard or safety issue. There is no substitute for a trained, alert operator.

1. Make certain the inside of the tank is completely drained of chemical residue and thoroughly flush the inside of the tank with clean water.
2. Remove and clean the filter if applicable.
3. Pump clean water through all areas of the plumbing including the mix tank, valves, and flow meter.
4. Open all drain points, valves, and filter to let as much of the liquid drain as possible.
5. Disconnect power to the flow meter.
6. Remove the flow meter from the machine and store in an area with the following aspects.
 - Ambient temperature of 50 to 80 degrees Fahrenheit.
 - Protection from direct sunlight to avoid unacceptable high surface temperatures.
 - Where moisture does not collect in and/or on the flow meter. This will help prevent fungus and bacteria infestation which can damage the liner.
 - Cover all openings
 - Store in a manner so that the inlet and outlet are as much in an up and down position as possible.

LP MASS FLOW METER

NOTES:

SECTION
G

MECHANICAL DRAWINGS

MASS FLOW METER KIT ASSEMBLY (13-04-0148)

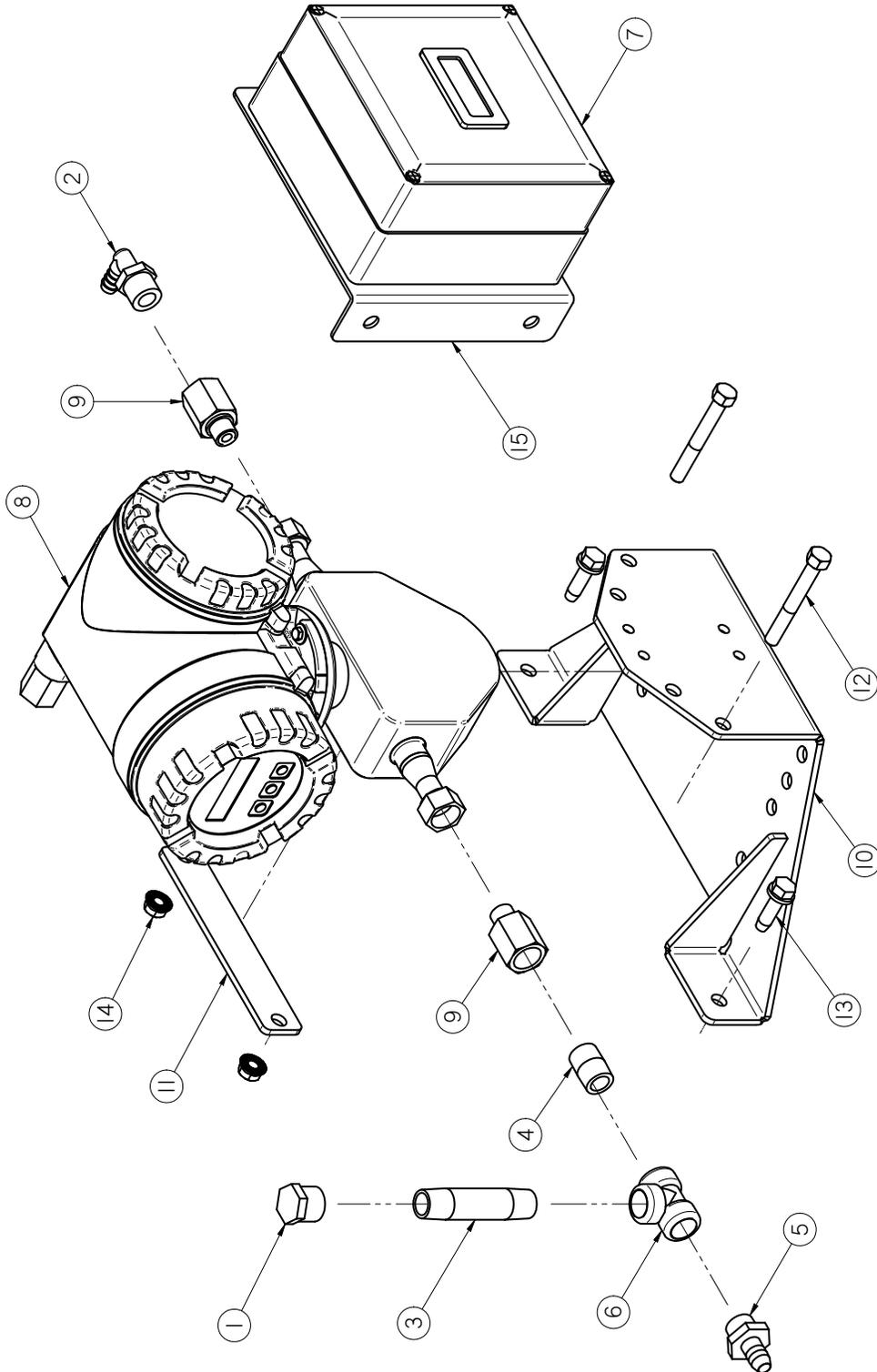

LP MASS FLOW METER

MASS FLOW METER KIT ASSEMBLY (13-04-0148)

Item #	Part #	Description	Qty
1	02-05-0086	FTTG END CAP .500 NPT BP	1
2	02-06-0010	FTTG 90 DEG .500HB X .500NPT ML NYL	1
3	02-07-0012	FTTG NIP .500 NPT X 3.50 PVC GRAY	1
4	02-07-0054	FTTG NIP .500 NPT X 1.125 TBE G-PVC	1
5	02-08-0007	FTTG STGHT .500HB X .500NPT ML NYL	1
6	02-09-0005	FTTG TEE .500 NPT PPE	1
7	03-12-0223	PNL CNTL MNL MASS FM KIT	1
8	03-18-0019	FLMT PROMASS 80E08 DN8 3/8IN	1
9	03-18-0021	FTTG ADPTR 1/2" VC0 X 1/2" FPT E+H	2
10	05-10-2033	BRKT FLMT MNT PROMAG 53H	1
11	05-10-3413	BRACKET FLMT CLAMP E&H 83E	1
12	06-01-0021	BOLT .375-16 X 3.00 ZP GR5	2
13	06-01-0118	BOLT STHRD .375-16 X 1.250 HH ZP	2
14	06-03-0014	NUT LOCK FLG .375-16 ZP GR5	2
15	1026BE	PNL BRKT FOR 03-11-0114	1

NOTICE

THESE ITEMS ARE NOT SHOWN IN THE DRAWING BUT ARE SHIPPED WITH THE KIT TO ACCOMMODATE OLDER LP TREATERS.

Part #	Description	Qty
02-05-0027	FTTG CPLG .375 HB X .500 HB NYL	2
02-06-0010	FTTG 90 DEG .500HB X .500NPT ML NYL	2
02-05-0003	FTTG CPLG .500 HB NYL WH	1
02-03-0005	HOSE RNT .500 CLEAR	5 FT
06-03-0014	NUT LOCK FLG .375-16 ZP GR5	2
06-01-0124	BOLT FLG .375-16 X .750 ZP GR5	2
06-07-0006	CLMP HOSE .500 TO .906 X .313W ZP	4

LP MASS FLOW METER

NOTES:

USC LIMITED WARRANTY

SECTION H

USC, LLC, (Manufacturer) warrants its seed treating equipment as follows:

1. **Limited Warranty:** Manufacturer warrants that the Products sold hereunder will be free from defects in material and workmanship for a period of 18 months from date of shipment. If the Products do not conform to this Limited Warranty during the warranty period, Buyer shall notify Manufacturer in writing of the claimed defects and demonstrate to Manufacturer satisfaction that said defects are covered by this Limited Warranty. If the defects are properly reported to Manufacturer within the warranty period, and the defects are of such type and nature as to be covered by this warranty, Manufacturer shall, at its expense, furnish replacement Products or, at Manufacturer's option, replacement parts for the defective products. Shipping and installation of the replacement Products or replacement parts shall be at the Buyer's expense.

2. **Other Limits:** THE FOREGOING IS IN LIEU OF ALL OTHER WARRANTIES, EXPRESSED OR IMPLIED, INCLUDING BUT NOT LIMITED TO THE IMPLIED WARRANTIES OF MERCHANTABILITY AND FITNESS FOR A PARTICULAR PURPOSE. Manufacturer does not warrant against damages or defects arising from improper installation (where installation is by persons other than Manufacturer), against defects in products or components not manufactured by Manufacturer, or against damages resulting from such non-Manufacturer made products or components. Manufacturer passes on to the Buyer the warranty it received (if any) from the maker of such non-Manufacturer made products or components. This warranty also does not apply to Products upon which repairs and / or modifications have been effected or attempted by persons other than pursuant to written authorization by Manufacturer. This includes any welding on equipment which could damage electrical components. Manufacturer does not warrant against casualties or damages resulting from misuse and / or abuse of Products, improper storage or handling, acts of nature, effects of weather, including effects of weather due to outside storage, accidents, or damages incurred during transportation by common carrier.

3. **Exclusive Obligation:** THIS WARRANTY IS EXCLUSIVE. The sole and exclusive obligation of Manufacturer shall be to repair or replace the defective Products in the manner and for the period provided above. Manufacturer shall not have any other obligation with respect to the Products or any part thereof, whether based on contract, tort, strict liability or otherwise. Under no circumstances, whether based on this Limited Warranty or otherwise, shall Manufacturer be liable for lost profits, lost revenue, lost sales (whether direct or indirect damages), incidental, special, punitive, indirect or consequential damages.

4. **Other Statements:** Manufacturer's employees or representatives' oral or other written statements do not constitute warranties, shall not be relied upon by Buyer, and are not a part of the contract for sale or this limited warranty.

5. **Return Policy:** Approval is required prior to returning goods to Manufacturer. A restocking fee will apply.

6. **Entire Obligation:** This Limited Warranty states the entire obligation of Manufacturer with respect to the Products. If any part of this Limited Warranty is determined to be void or illegal, the remainder shall remain in full force and effect.

US / Canada Non-Exclusive 2016



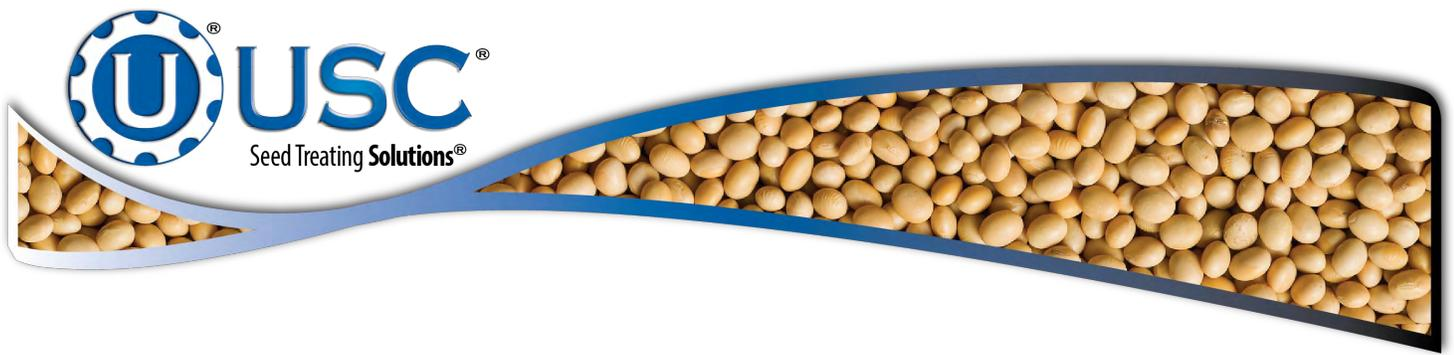

USC, LLC

2320 124th road

Sabetha, KS 66534

PHONE: (785) 431-7900

FAX: (785) 431-7950

EMAIL: sales-team@uscllc.com

WEB: www.uscllc.com

