

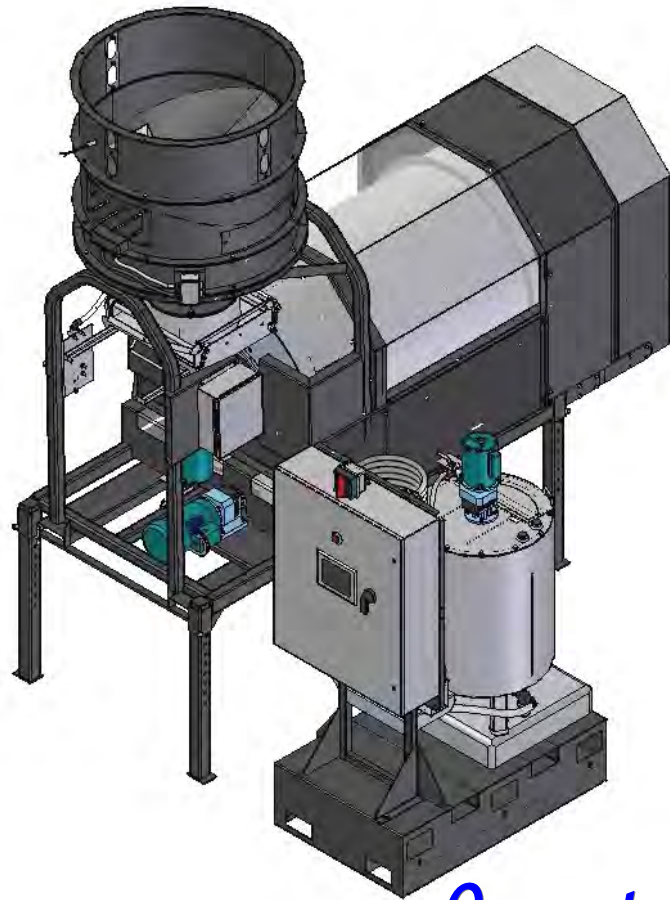

# MX850 SEED TREATER



## *Operator's Manual*

*Version 2.04*



# **INTRODUCTION**

Thank you for choosing USC, LLC for your equipment needs. We appreciate your business and will work diligently to ensure that you are satisfied with your choice.

## **OVERVIEW**

The purpose of this manual is to provide you with the basic information needed to operate and maintain the MX850. It does not hold USC, LLC liable for any accidents or injuries that may occur.

## **OPERATOR RESPONSIBILITIES**

As the purchaser/owner/operator of this equipment and control system, you have an obligation to install, operate, and maintain the equipment in a manner that minimizes the exposure of people in your care to any potential hazards inherent in using this equipment. It is critical that the owner of this equipment:

- Has a clear and documented understanding of the process this machine is being used in and of any resulting hazards or special requirements arising from this specific application.
- Allow only properly trained and instructed personnel to install, operate, or service this equipment.
- Maintain a comprehensive safety program involving all who work with this machine and other associated process equipment.
- Establish clear areas of staff responsibility (e.g. operation, setup, sanitation, maintenance, and repairs).
- Provide all personnel with necessary safety equipment.
- Periodically inspect the equipment to insure that the doors, covers, guards, and safety devices are in place and functioning, that all safety instructions and warning labels are intact and legible, and that the equipment is in good working order.
- In addition to the operating instructions, observe and enforce the applicable legal and other binding regulations, national and local codes.

As the person with the most to gain or lose from working safely, it is important that you work responsibly and stay alert. By following a few simple rules, you can prevent an accident that could injure or kill you or a co-worker.

*MX850*

- Do not operate, clean, or service this equipment until you have read and understood the contents of this manual. If you do not understand the information in this manual, bring it to the attention of your supervisor, or call your local USC dealer for assistance.
- Any operator who is known or suspected to be under the influence of alcohol or drugs should not be allowed to operate the equipment.
- Understand and follow the safety practices required by your employer and this manual.
- **PAY ATTENTION** to what you and other personnel are doing and how these activities may affect your safety.
- **Failure to follow these instructions may result in serious personal injury or death.**

**RECEIVING YOUR EQUIPMENT**

As soon as the equipment is received, it should be carefully inspected to make certain that it has sustained no damage during shipment and that all items listed on the packing list are accounted for. If there is any damage or shortages, the purchaser must immediately notify your USC dealer. Ownership passes to purchaser when the unit leaves the USC, LLC. premises. The purchaser is responsible for unloading and mounting all components of the equipment.

Document the serial number of the machine for future reference. Below are pictures showing where the serial numbers are located.

*MX Series  
Serial Number*

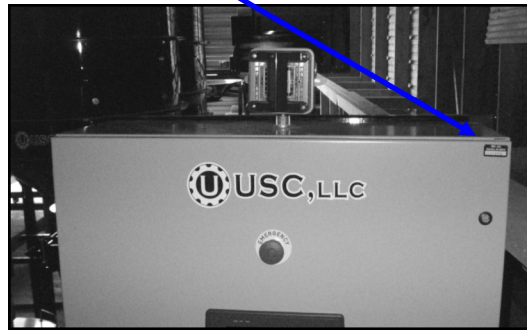
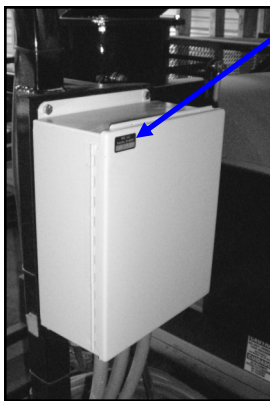

**LX SEED TREATER SERIAL NUMBER:** \_\_\_\_\_

# TABLE OF CONTENTS

<b><u>Section</u></b>	<b><u>Contents</u></b>	<b><u>Page #</u></b>
<b>Section A</b>	<b>Safety Instructions.....</b>	<b>5</b>
<b>Section B</b>	<b>Installation .....</b>	<b>12</b>
<b>Section C</b>	<b>Mechanical Operation.....</b>	<b>16</b>
	System Overview .....	16
	Supply Hopper & Seed Wheel .....	18
	Atomizer .....	19
	Rotating Drum .....	19
	Pump Stand .....	19
<b>Section D</b>	<b>Electrical Operation .....</b>	<b>22</b>
	Main Screen .....	24
	H-O-A Screen.....	27
	Utilities Screen .....	31
	Security Screen.....	33
	Tools & Options Screen .....	35
<b>Section E</b>	<b>Calibration .....</b>	<b>39</b>
	Seed Flow Calibration .....	39
	Pump Calibration .....	42
	Flow Meter Calibration .....	43
	Treating Seed .....	44
	Reports.....	46
	Seed Wheel Calibration .....	48
	Printing & Uploading Reports.....	49
<b>Section F</b>	<b>Troubleshooting &amp; Alarms .....</b>	<b>56</b>
	Troubleshooting .....	56
	Proximity Switch Adjustment Guide .....	58
	System Alarms - Faults .....	59
	Paused Controlled Warning .....	62
	System Messages.....	63
<b>Section G</b>	<b>Maintenance .....</b>	<b>64</b>
<b>Section H</b>	<b>Storage.....</b>	<b>67</b>
<b>Section I</b>	<b>Mechanical Drawings .....</b>	<b>70</b>
<b>Section J</b>	<b>Limited Warranty.....</b>	<b>91</b>

# SAFETY INSTRUCTIONS

## SECTION A

Every year accidents in the work place maim, kill, and injure people. Although it may be impossible to prevent all accidents, with the right combination of training, operating practices, safety devices, and operator vigilance, the number of accidents can be significantly reduced. The purpose of this section is to educate equipment users about hazards, unsafe practices, and recommended hazard avoidance techniques.

### SAFETY WORDS AND SYMBOLS

It is very important that operators and maintenance personnel understand the words and symbols that are used to communicate safety information. Safety words, their meaning and format, have been standardized for U.S. manufacturers and published by the American National Standards Institute (ANSI). The European Community (E.C.) has adopted a different format based on the International Standards Organization (I.S.O.) and applicable machinery directives. Both formats are presented below. Graphic symbols are not standardized, but most manufacturers will use some variation of the ones seen in this manual.



Indicates an imminently hazardous situation which, if not avoided, **will** result in death or serious injury.



Indicates a potentially hazardous situation which, if not avoided, **could** result in death or serious injury.



Indicates a potentially hazardous situation which, if not avoided, **may** result in minor or moderate injury and/or property damage.



Provides additional information that the operator needs to be aware of to avoid a potentially hazardous situation.



**Mandatory Lockout Power Symbol.** Disconnect, lockout, and tagout electrical and other energy sources before inspecting, cleaning, or performing maintenance on this panel.



**International Safety Alert Symbol.** The exclamation point (!) surrounded by a yellow triangle indicates that an injury hazard exists. However, it does not indicate the seriousness of potential injury. The exclamation point (!) is also used with the DANGER, WARNING, and CAUTION symbols so the potential injury is indicated.



**Electrocution Hazard Symbol.** This symbol indicates that an electrocution hazard exists. Serious injury or death could result from contacting high voltage.



**International Electrocution Hazard.** This symbol indicates that an electrocution hazard exists. Serious injury or death could result from contacting high voltage.



**Mandatory Read Manual Action Symbol.** (I.S.O. format)  
This symbol instructs personnel to read the Operators Manual before servicing or operating the equipment.



**Mandatory Read Manual Action Symbol.** This symbol instructs personnel to read the Operators Manual before servicing or operating the equipment.



Notice is used to notify people of important installation, operation, or maintenance information which is not hazard related.

## **LOCKOUT / TAGOUT PROCEDURES**

Lockout/Tagout is the placement of a lock/tag on an energy isolating device in accordance with an established procedure. When taking equipment out of service to perform maintenance or repair work, always follow the lockout/tagout procedures as outlined in ANSI Z344.1 and/or OSHA Standard 1910.147. This standard “requires employers to establish a program and utilize procedures for affixing appropriate lockout devices or tagout devices to energy isolating devices and to otherwise disable machines or equipment to prevent unexpected energizing, start-up, or release of stored energy in order to prevent injury to employees.”

## **EMERGENCY STOP**



There are two Emergency Stop push buttons on the MX Series Seed Treater, which are located on the main control panel and the treater junction box. Actuators of emergency stop shall be colored RED. The background immediately around the device actuator shall be colored YELLOW. The actuator pushbutton-operated device shall be of the palm or mushroom head type.

## **CONTROLLED STOP**

This is the stopping of machine motion by reducing the electrical command signal to 0 (zero) once the stop signal has been recognized.

## **HAZARD REVIEW**

### **Electrocution Hazard**



Electrocution accidents are most likely to occur during maintenance of the electrical system or when working on or near exposed high voltage wiring. This hazard does not exist when the electrical power has been disconnected, properly locked, and tagged out.

### **Automatic Start Hazard**



This seed treating system is usually controlled by an automated system and may start without warning. Failure to properly disconnect, lockout, and tagout all energy sources of remotely controlled equipment creates a very hazardous situation and could cause injury or even death. PLEASE STAY CLEAR AND BE ALERT.



**YOU** are responsible for the **SAFE** operation and maintenance of your USC, LLC Seed Treating System. **YOU** must ensure that you and anyone else who is going to operate, maintain, or work around the Seed Treating System be familiar with the operating and maintenance procedures and related **SAFETY** information contained in this manual. This manual will take you step-by-step through your working day and alert you to good safety practices that should be adhered to while operating the Seed Treating System.

Remember, **YOU** are the key to safety. Good safety practices not only protect you, but also the people around you. Make these practices a working part of your safety program. Be certain that **EVERYONE** operating this equipment is familiar with the recommended operating and maintenance procedures and follows all the safety precautions. Most accidents can be prevented. Do not risk injury or death by ignoring good safety practices.

- MX Series Seed Treater owners must give operating instructions to operators or employees before allowing them to operate the machine, and at least annually thereafter per OSHA (Occupational Safety and Health Administration) regulation 1928.57.
- The most important safety device on this equipment is a **SAFE** operator. It is the operator's responsibility to read and understand **ALL** Safety and Operating instructions in the manual and to follow them. All accidents can be avoided.
- A person who has not read and understood all operating and safety instructions is not qualified to operate the machine. An untrained operator exposes himself and bystanders to possible serious injury or death.
- Do not modify the equipment in any way. Unauthorized modification may impair the function and/or safety and could affect the life of the equipment.
- Think SAFETY! Work SAFELY!

### **GENERAL SAFETY**

1. Read and understand the Operator's Manual and all safety signs before operating, maintaining, adjusting or unplugging the MX Series Seed Treater.
2. Only trained persons shall operate the seed treater. An untrained operator is not qualified to operate the machine.
3. Have a first-aid kit available for use should the need arise, and know how to use it.





4. Provide a fire extinguisher for use in case of an accident. Store in a highly visible place.
5. Do not allow children, spectators or bystanders within hazard area of machine.
6. Wear appropriate protective gear. This includes but is not limited to:

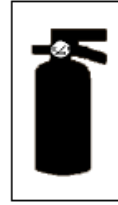

- A hard hat
- Protective shoes with slip resistant soles
- Protective goggles
- Heavy gloves
- Hearing protection
- Respirator or filter mask



7. Place all controls in neutral or off, stop motor, and wait for all moving parts to stop. Then disable power source before servicing, adjusting, repairing, or unplugging.



8. Review safety related items annually with all personnel who will be operating or maintaining the MX Series Seed Treater.

### **OPERATING SAFETY:**

1. Read and understand the Operator's Manual and all safety signs before using.
2. Disconnect and disable electrical supply completely and wait for all moving parts to stop before servicing, adjusting, repairing or unplugging.
3. Clear the area of bystanders, especially children, before starting.
4. Be familiar with the machine hazard area. If anyone enters hazard area, shut down machine immediately. Clear the area before restarting.
5. Keep hands, feet, hair and clothing away from all moving and/or rotating parts.
6. Stay away from overhead obstructions and power lines during operation and transporting. Electrocution can occur without direct contact.
7. Do not operate machine when any guards are removed.
8. Inspect welds and repair if needed.

## **PLACEMENT SAFETY**

1. Move only with the appropriate equipment
2. Stay away from overhead power lines when moving Seed Treating System. Electrocutation can occur without direct contact.
3. Be familiar with machine hazard area. If anyone enters hazard areas, shut down machine immediately. Clear the area before restarting.
4. Operate the Seed Treater on level ground free of debris. Anchor the Seed Treater to prevent tipping or upending.



Before placement of the Seed Treater, be sure that ground is reasonably level. The Seed Treater may topple or work improperly if the ground is too uneven, damaging the equipment and/or causing personal injury.

## **MAINTENANCE SAFETY**

1. Review the Operator's Manual and all safety items before working with, maintaining or operating the Seed Treating System.
2. Place all controls in neutral or off, stop motors, disable power source, and wait for all moving parts to stop before servicing, adjusting, repairing or unplugging.
3. Follow good shop practices:  
Keep service area clean and dry.  
Be sure electrical outlets and tools are properly grounded.  
Use adequate light for the job at hand.
4. Keep hands, feet, hair and clothing away from all moving and/or rotating parts.
5. Clear the area of bystanders, especially children, when carrying out any maintenance and repairs or making any adjustments.
6. Before resuming work, install and secure all guards when maintenance work is completed.
7. Keep safety signs clean. Replace any sign that is damaged or not clearly visible.



## **SAFETY SIGNS**

1. Keep safety signs clean and legible at all times.
2. Replace safety signs that are missing or have become illegible.
3. Replaced parts that displayed a safety sign should also display the current sign.
4. Safety signs are available from your Authorized Dealer.

### **How to Install Safety Signs:**

- Be sure that the installation area is clean and dry.
- Be sure temperature is above 50°F (10°C).
- Decide on the exact position before you remove the backing paper.
- Remove the smallest portion of the split backing paper.
- Align the sign over the specified area and carefully press the small portion with the exposed sticky backing in place.
- Slowly peel back the remaining paper and carefully smooth the remaining portion of the sign in place.
- Small air pockets can be pierced with a pin and smoothed out using the piece of sign backing paper.



Located on the USC equipment you will find safety labels. Always be sure to read and follow all directions on the labels.



Guards provided with USC Seed treater are to remain in place during operation.

SECTION  
B**INSTALLATION**

**HIGH VOLTAGE** ~ Always disconnect the power source before working on or near the control panel or lead wires.



**HIGH VOLTAGE** ~ Use insulated tools when making adjustments while the controls are under power.



Permanent installation may require additional electrical cords, liquid hose, and air lines, since each installation is unique.

**SET-UP**

The following steps outline the initial set-up of your USC Seed Treating system:

1. Clear the area of bystanders, especially small children, before moving.
2. Be sure there is enough clearance from overhead obstructions and power lines or other equipment to move the machine into its working position.
3. Using a forklift, place the seed treater in the desired position on a level surface.

**NOTICE** USC highly recommends that the seed treater be set up inside a building or any covered structure to protect the machine from weathering.

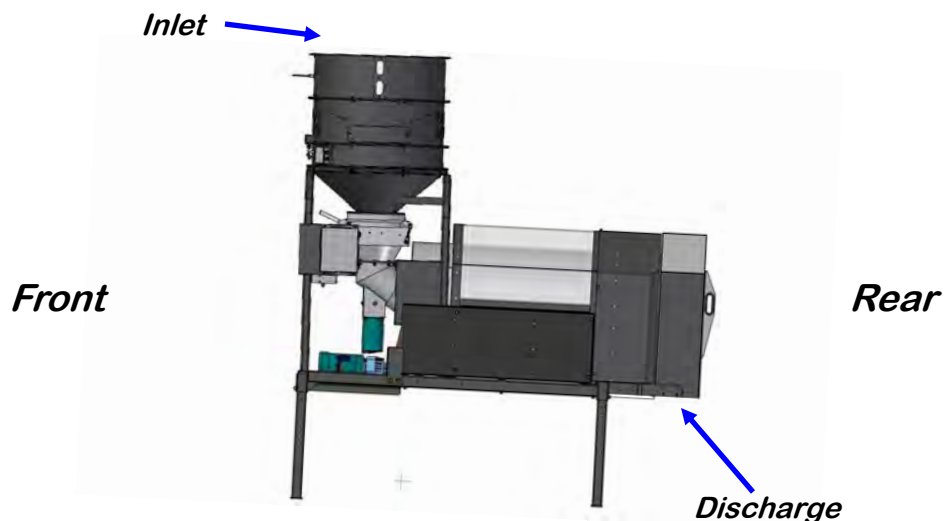

4. Remove any boxes from the drum of the treater.
5. Install the four legs provided and set up on a level surface, preferably concrete. When all four legs are mounted in the same pin hole, the seed treater has a slight slope to allow seed to travel through the machine. The pin holes are approximately 2” apart.

**NOTICE** If more slope is desired, the rear legs can be dropped an additional pin hole.

6. Anchor the seed treater in position to prevent the machine from moving during operation.
7. Inspect machine thoroughly for screws, bolts, fittings, etc. which may have come loose during shipping.
8. The pump stand should be placed on level ground close to the seed treater.
9. Attach the tubing from the pump skid to the atomizer on the seed treater (below left). Additional tubing can be added or removed to accommodate your set-up.
10. Connect the cords from the seed treater junction box to the main control panel. The receptacles are found on the bottom of the main control panel. (below right)

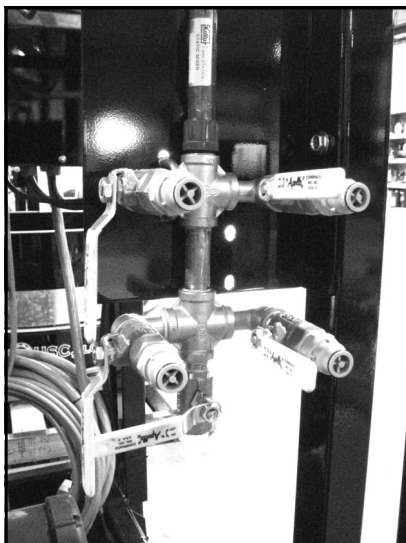

*Plumbing to Atomizer*

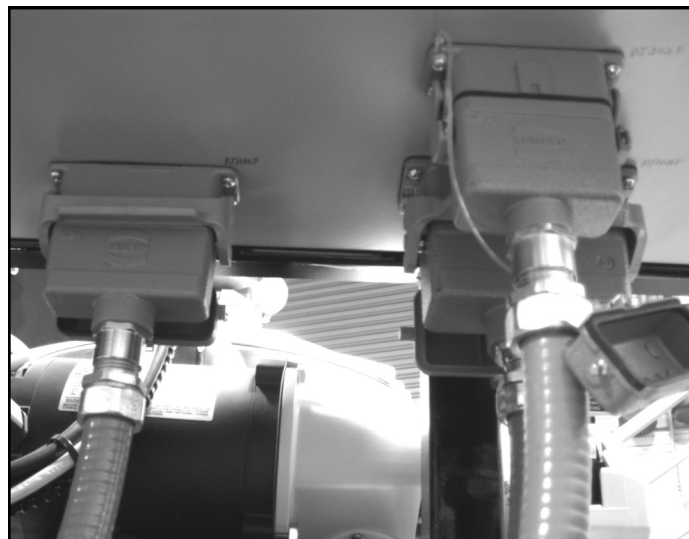

*Main Control Panel Cord Connections*

11. Supply approximately 100 pounds of air pressure to the center port of the air actuated 3-way valve located on the pump skid behind the electric control panel.

**Air Supplied Here**

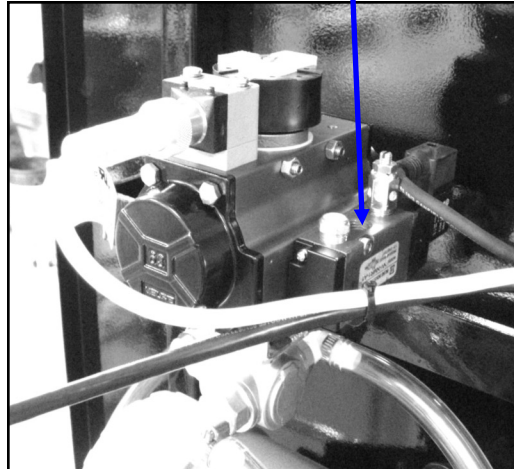

12. Connect a dedicated analog phone line to the modem located in the top left portion of the control panel. This will allow USC remote access to the seed treater to help diagnose and fix problems that may arise.

**Analog Phone Line Hooked Up Here**



13. Have a certified electrician provide power to the seed treating system. Provide convenient shutdown switches, comply with local electrical codes and ensure that the system is properly grounded and bonded. The USC system must be connected to the same electrical requirements as specified in the main control panel on the power requirement tag, or the electrical schematic shipped with the piece of equipment. This will power the entire USC system.



*MX850*

14. A service port located on the side of the main control panel will allow the operator to connect a printer and an Ethernet connection to the unit. The printer connection will allow the user to print reports directly from the reports screen.

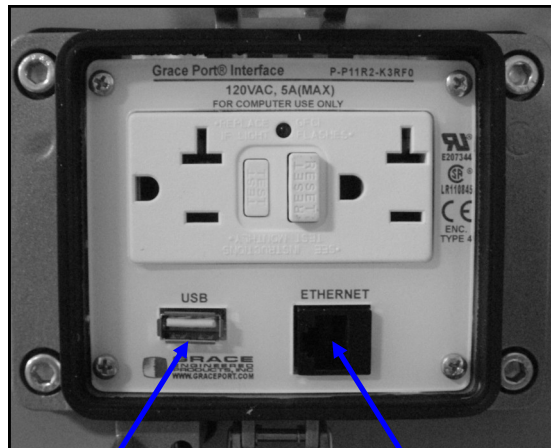

*Printer  
Connection*

*Ethernet  
Connection*

**SYSTEM OVERVIEW**

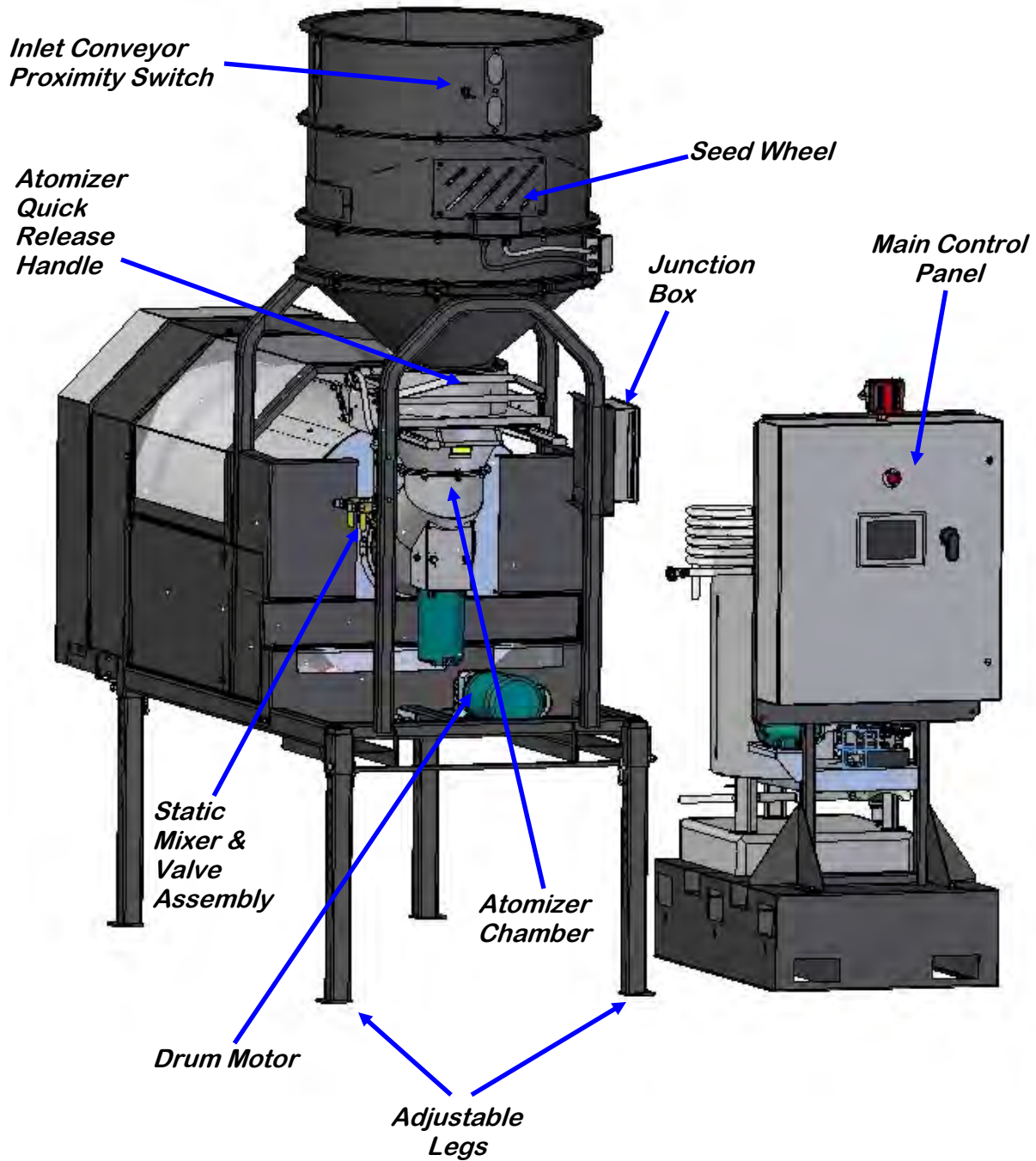



**SYSTEM OVERVIEW**

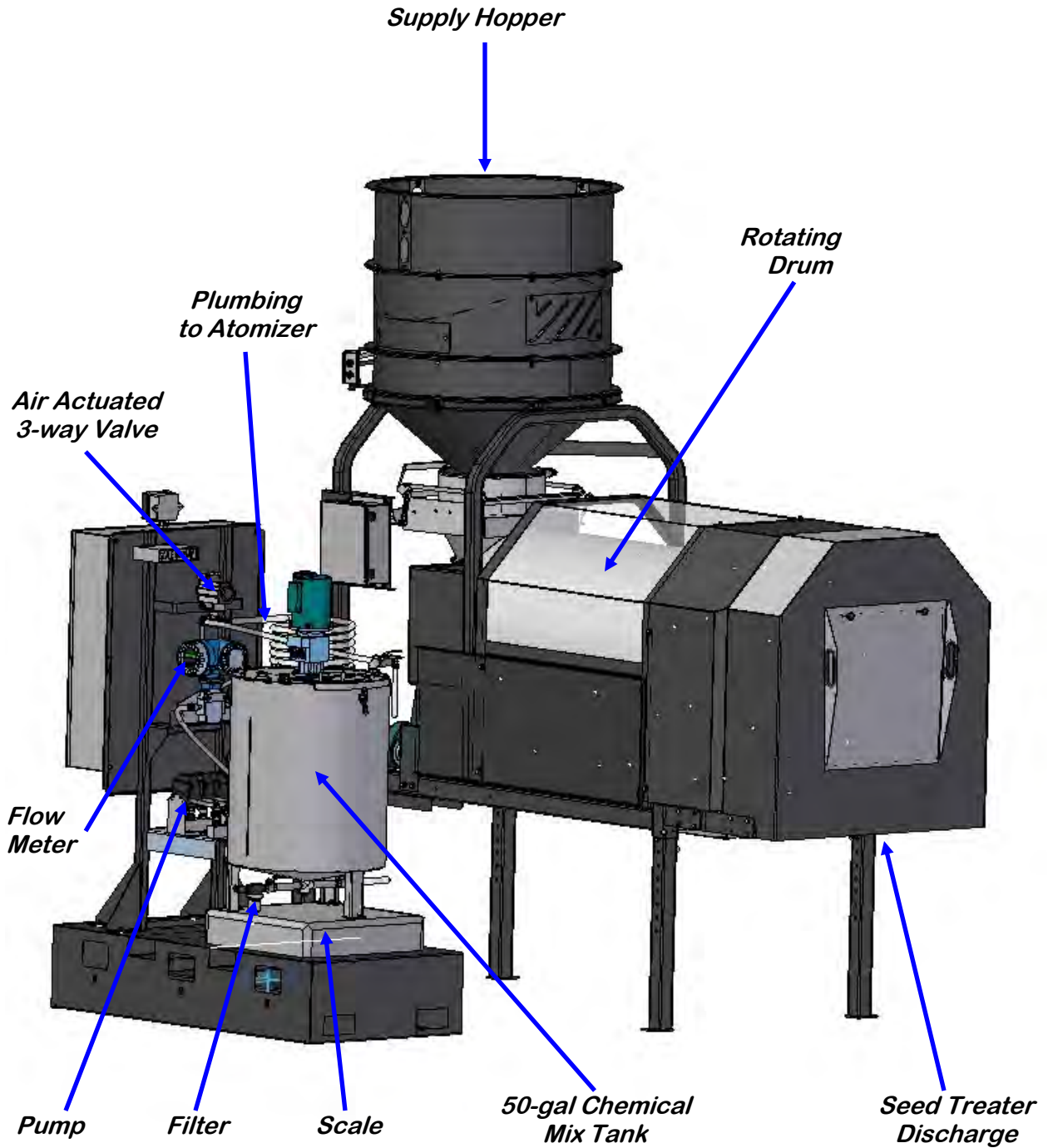

**SUPPLY HOPPER & SEED WHEEL**

The hopper is equipped with three proximity switches. The top switch controls the inlet conveyor and the lower switches, located in the seed wheel, control the pump(s). Refer to “H-O-A Screen” in section D and Section F: Troubleshooting; “Proximity Switch Adjustment Guide” for more in-depth information on these switches.

The Seed Wheel is designed to simplify and increase seed flow calibration accuracy. A rotating wheel is driven by a variable speed motor, which is set prior to treating the seed. This is mounted above the atomizer. The wheel consists of 8 identical pockets approximately 4 inches deep. As it rotates, the wheel captures a certain amount of seed in each pocket. After the seed is caught, the wheel continues rotation and dispenses the seed into the atomizer chamber. With the constant turn of the wheel, there is a consistent amount of seed always sent through the atomizer.

A cup is used to represent a certain percentage of one of the wheels pockets. To calibrate the seed flow, take a sample of the seed to be treated using the cup and weigh it. From the weight of the seed sample and by also knowing the RPM of the wheel, you can determine how fast that seed type will pass through the seed treater.

The purpose of the seed wheel is to simplify calibration and make seed flow calibration more accurate. The seed wheel saves time when switching to different seed sizes and seed types.

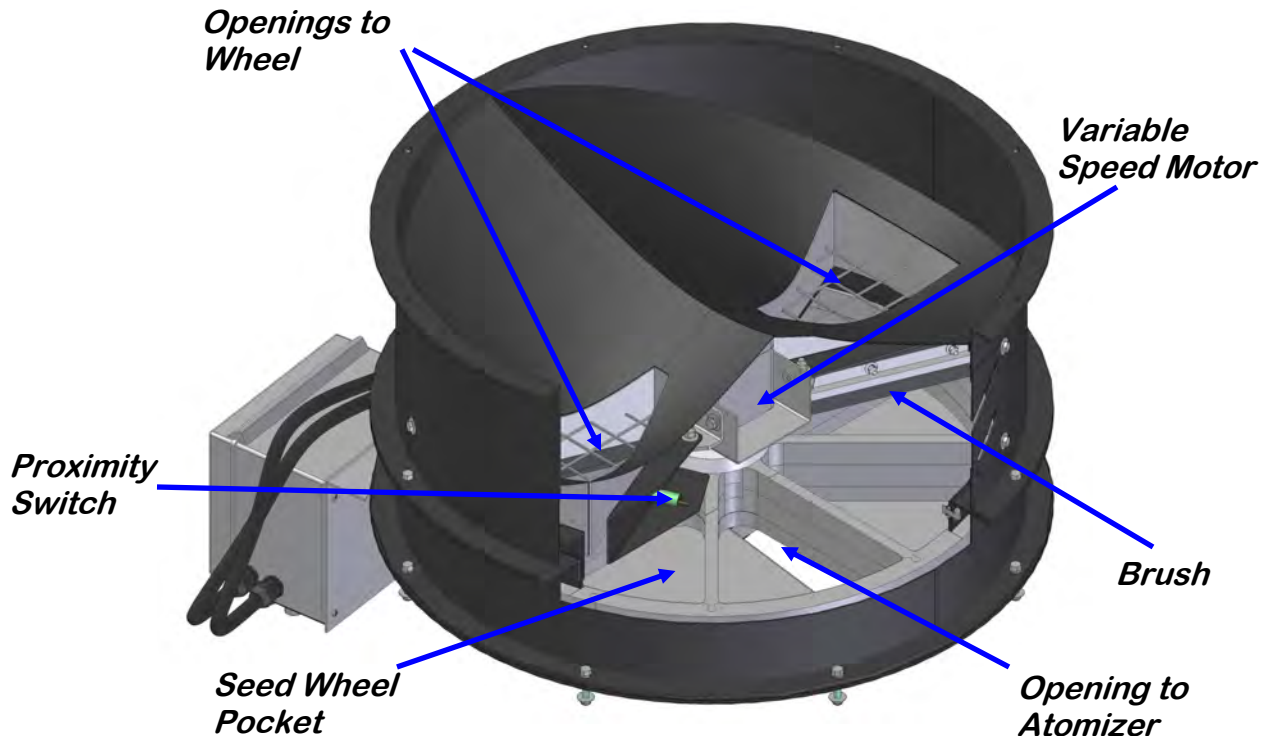

## **ATOMIZER CHAMBER**

The atomizer chamber consists of a patented design which disperses treatment evenly to each seed. A variable speed motor drives the atomizer head. As treatment is being pumped into the atomizer chamber, it drops into the atomizer head. The centrifugal force of the spinning head causes the treatment to be sprayed out through a screen covering all 360 degrees. Meanwhile, seed drops down out of the seed wheel, down on top of a distribution cone, and down through the atomizer chamber. The distribution cone creates a curtain of seed which wraps around the atomizer head, ensuring that every seed is applied with treatment.

---

## **ROTATING DRUM**

The stainless steel rotating drum accepts treated seed through the opening on the hopper end. As seed passes through the length of the drum it is tumbled, producing accurate and uniform seed coating. The seed then exits the seed treater out the discharge end of the machine.



Never allow exposure of persons or clothing to the drive shaft, idler wheels, or the drum during operation. Always have the safety shields in place during operation.

---

## **PUMP STAND**

The USC MX series seed treater is equipped with a 50-gallon mix tank with an electric drive liquid agitator to keep chemicals mixed and in suspension. The agitator should be running at all times when chemical is present. The tank is equipped with a shut-off and drain valve located on the bottom. The tank sits atop a scale which is used to measure out product.

The pump stand utilizes a variable speed peristaltic pump with 3 pump heads and special neoprene pump tubing for chemical metering. The liquid being used only comes into contact with the inside diameter of the tubing and not the pump. This allows for easy cleanup and maintenance without disassembling the pump.

To open the pump heads, turn the levers to the left. Place pump tubing inside the pump heads so it fits inside the notches and above the rollers. Turn lever back to the right to close the pump head, clamping the hose inside the head. Wear or fatiguing of the tubing within the pump head due to compression is normal. When tubing becomes worn or chemical rates begin to slow down, open the pump head and move the tubing to a different position. If the entire piece of tubing becomes worn, simply replace with a new section. When not using the seed treater for several days or when storing, open the pump head and remove the tubing to prevent any extra compression. Worn tubing should be moved to a different position every week to prevent additional wear.

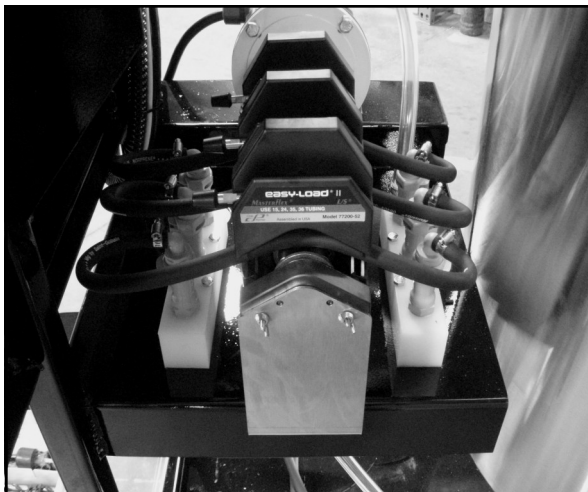

*Pump Heads Open*

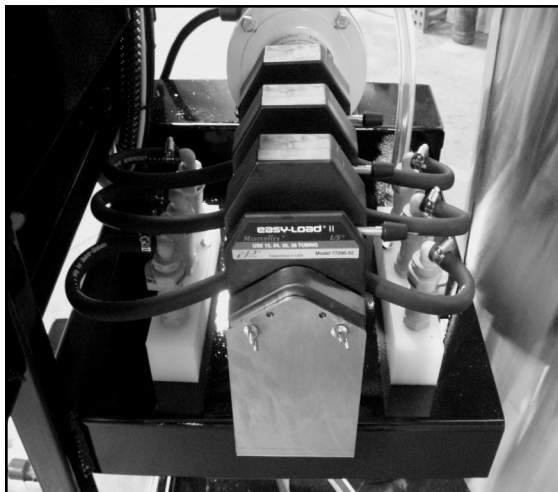

*Pump Heads Closed*

If a very low rate is needed, a section of tubing can be removed to force the pump motor to run at a higher speed. This allows for a more consistent flow rate. When removing the tubing, uncouple it from the manifold (below left). If the tubing is unclamped from the pump head but left coupled in the manifold (below right), the pump will suck air and cause flow rates to be very inconsistent.

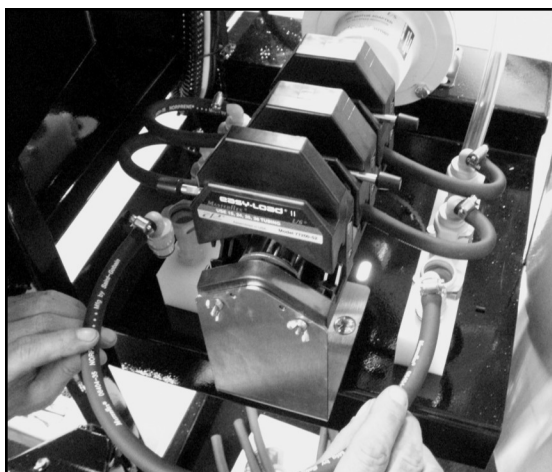

The pump stand is also equipped with a flow meter, which is used to determine the liquid flow rate. The flow meter measures in ounces or milliliters per minute and total ounces or total milliliters.



Proper calibration is critical to achieve a proper granular/chemical mixture. The liquid pump is controlled by a variable speed motor. An air actuated 3-way valve helps in calibration by controlling whether treatment is pumped back into the tank or to the atomizer.

Emptying the remaining chemical can be done by reversing the pump back into the mix tank and then draining the liquid into a suitable container. Clean water should be pumped through the flow meter, valves, and mix tank when finished.



Always dispose of chemical or diluted chemical according to your local, state, and federal regulations.

Only you, the operator, can determine the length of time required to completely rinse all chemical residue from the tank and plumbing system.

SECTION  
D**ELECTRICAL OPERATION**

**HIGH VOLTAGE** ~ Always disconnect the power source before working on or near the control panel or lead wires.



**HIGH VOLTAGE** ~ Use insulated tools when making adjustments while the controls are under power.



**AUTHORIZED PERSONNEL** only shall work on the control panel. Never allow anyone who has not read and familiarized themselves with the owner's manual to open or work on the control panel.

This section provides a general overview and description of the operator controls for the MX Series Seed Treater.

**General Panel Descriptions**

This system consists of two panels (three more optional panels):

- The Main Control Panel (MCP) is a 36 x 30 x 10 inch enclosure that contains all of the electrical control components as well as the HMI (Human/Machine Interface) touch screen. The operator is able to control the entire system through the HMI.
- Junction box #1, located on the seed treater frame, connects all components of the treater module to the main control panel. Junction Box #1 is plug-connected to the MCP.
- Junction box #2 is located on a separate pump/ mix tank stand. This second pump/ mix tank stand is an optional add-on package and is plug-connected to the MCP.
- Junction box #3 is located on a separate pump/ mix tank stand. This third pump/ mix tank stand is an optional add-on package and is plug-connected to the MCP.
- Junction box #4 is located on a separate pump/ mix tank stand. This fourth pump/ mix tank stand is an optional add-on package and is plug-connected to the MCP.

*MX850*

## **Main Control Panel**

The following pages explain the function of the touch screen controls.

## **USC STARTUP SCREEN**

This screen is the first screen the operator will see after the system receives power. Touch this screen to allow the operator to advance to the Main Screen.



### MAIN SCREEN

This screen informs the operator of the status of all system motors and electrical devices and allows for control/adjustment of system operations.

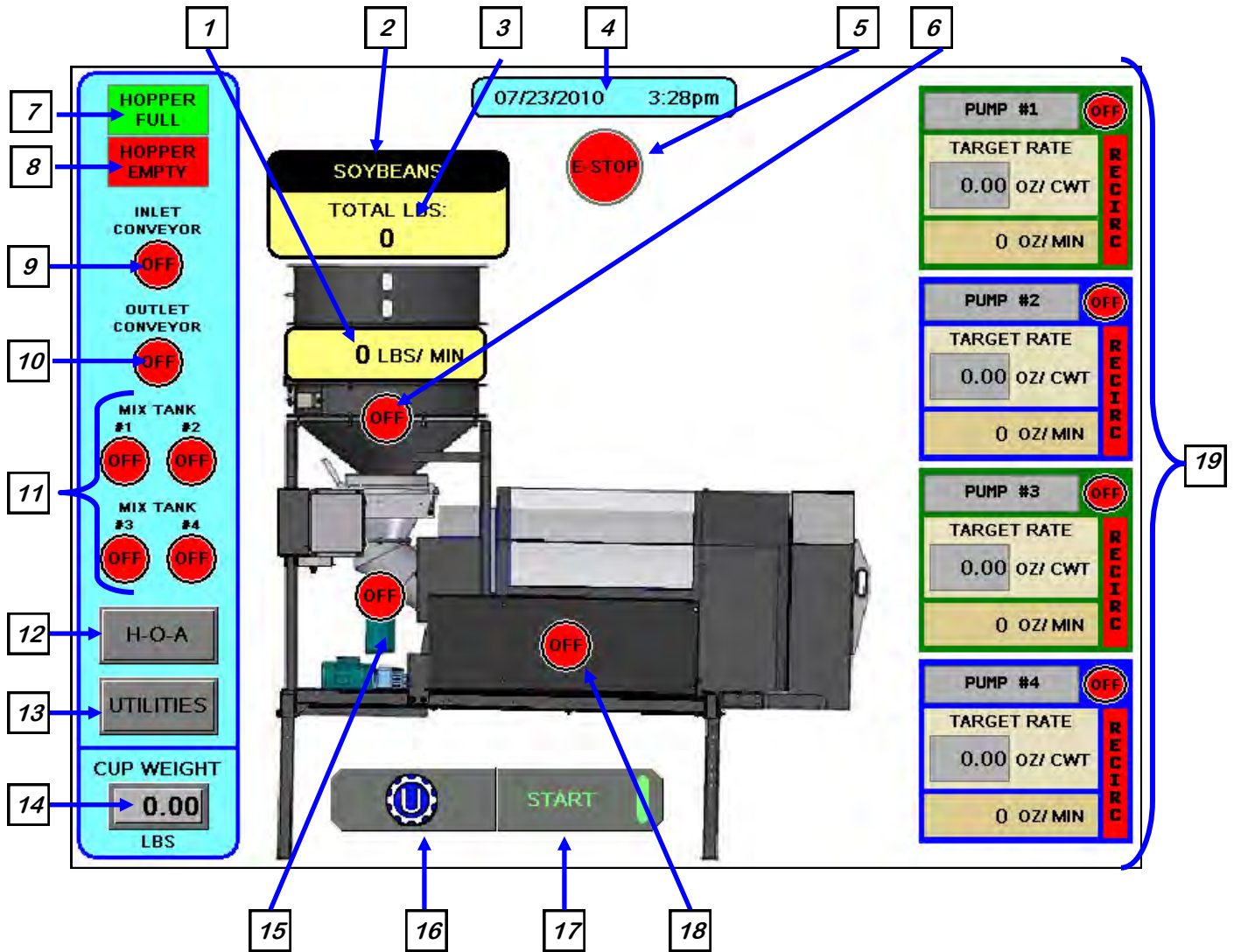



### **Main Screen Button Descriptions**

- 1. Seed Flow Rate:** Displays the seed flow rate in pounds per minute.
- 2. Seed Type Indicator:** Displays the type of seed has been selected in the “Product Selection” Screen.
- 3. Totalized Weight Display:** Displays the total pounds of seed as it passes through the seed wheel.
- 4. Current Date and Time Display**
- 5. Emergency Stop Indicator:** This blinking display is activated when the system E-Stop button is activated.
- 6. Seed Wheel Motor Status Indicator:** Informs the operator if the seed wheel is “ON” or “OFF”
- 7. Hopper Full:** Informs the operator when the proximity switch located in the supply hopper above the seed wheel is detecting seed.
- 8. Hopper Empty:** Informs the operator when the proximity switches located in the seed wheel are not detecting seed.
- 9. Inlet Conveyor Motor Status Indicator:** Informs the operator if the inlet conveyor is “ON” or “OFF.”
- 10. Outlet Conveyor Motor Status Indicator:** Informs the operator if the outlet conveyor is “ON” or “OFF.”
- 11. Mix Tanks Motor Status Indicator:** Informs the operator if the agitation motors are “ON” or OFF”
- 12. “H-O-A” (Hand-Off-Auto):** This button advances the operator to the “H-O-A” screen.
- 13. “UTILITIES”:** This button advances the operator to the “Utilities” screen.
- 14. “CUP WEIGHT”:** Pressing this button will bring up a numeric keypad (below) which allows the operator to input the “cup weight” for the Seed Wheel. This weight is used to calculate the seed flow rate the seed wheel will output.



**15. Atomizer Motor Status Indicator:** Informs the operator if the Atomizer motor is “ON” or “OFF.”

**16. USC Logo Button:** Allows the operator to exit back to the Startup Screen.

**17. STARTUP Button:** This is used to start the machine after all motors have been placed into the AUTO position.

**18. Drum Drive Motor Status Indicator:** Informs the operator if the drive motor is “ON” or “OFF.”

**19. Pump Status Modules:** This block of information informs the operator of the following: Pump motor status (“ON” or “OFF”), target flow rate, and actual flow rate from flow meter.

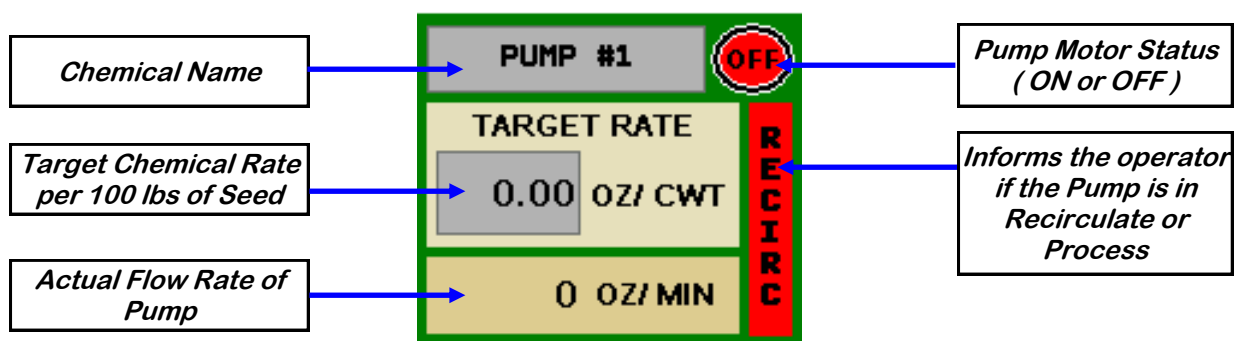

### “H-O-A” (HAND-OFF-AUTO) SCREEN

Hand-Off-Auto controls are provided for most of the automated devices in the system, and are accessed on this screen.



These H-O-A buttons force the selected component to be energized (HAND), de-energized (OFF), or automatically energized by the normal logic sequence (AUTO). The HAND function will cause the component to operate independent of whatever else the system is trying to do automatically. These functions should not normally be used if the automated sequencing is active. **Be sure to understand the impact of energizing or de-energizing a component with the HAND/OFF settings before using them.** These commands are not a substitute for Lockout/Tagout procedures when working on or near this machine. Use proper lockout/tagout procedures to disable the equipment before servicing it.

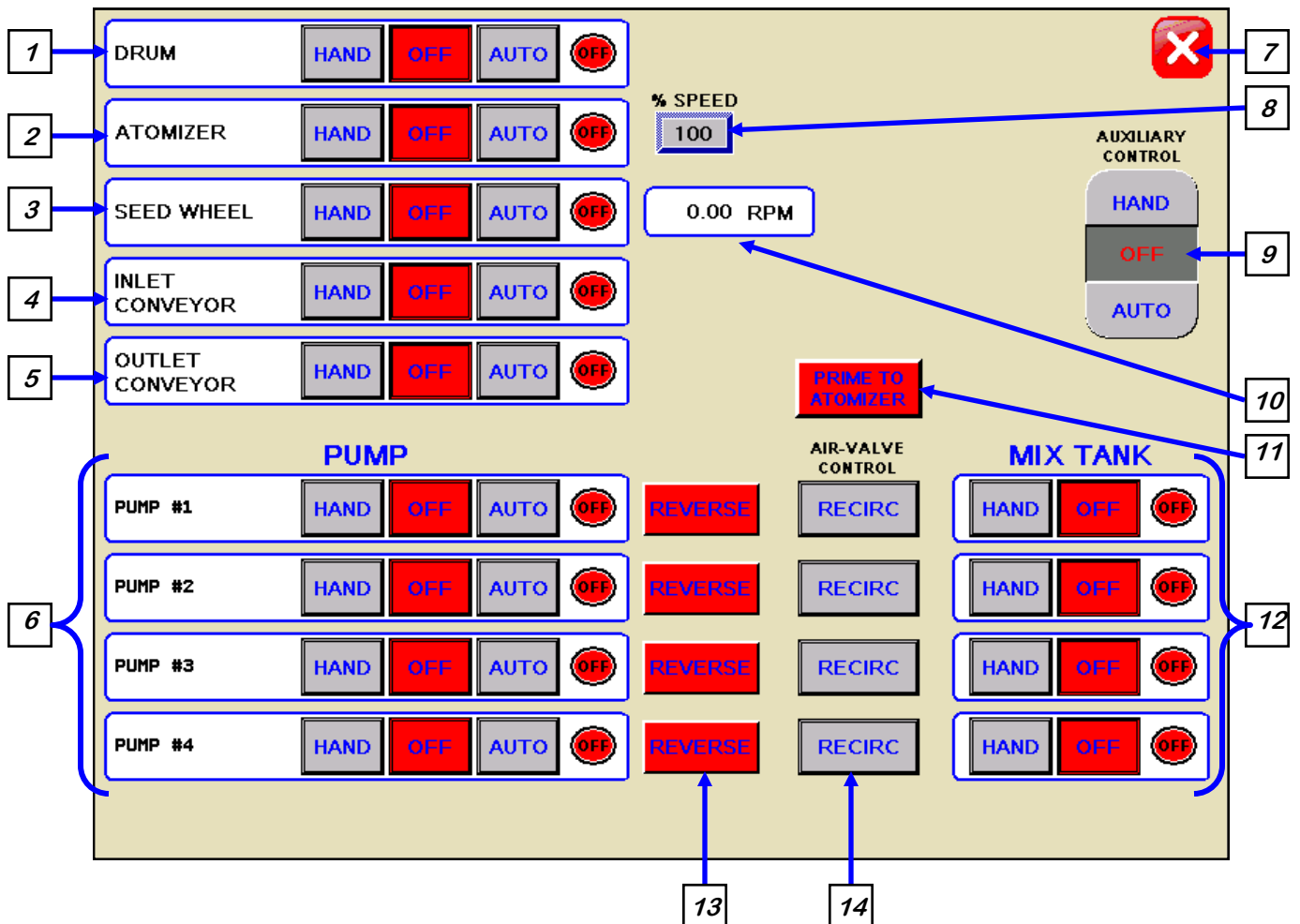

## H-O-A Button Descriptions

**1. Drum Control Module:** This module controls the function of the drum. The “HAND” button will place the drum in the manual mode of operation. The “OFF” button will turn the associated device in the “OFF” mode of operation. The “AUTO” button will place the device in the automatic mode of operation. The motor will not operate in this function unless all other devices are in the “AUTO” mode and the “STARTUP” button is pressed on the main menu.

**2. Atomizer Control Module:** This module controls the function of the atomizer. The “HAND” button will place the atomizer in the manual mode of operation. The “OFF” button will turn the associated device in the “OFF” mode of operation. The “AUTO” button will place the device in the automatic mode of operation. The motor will not operate in this function unless all other devices are in the “AUTO” mode and the “STARTUP” button is pressed on the main menu.

**3. Seed Wheel Control Module:** This module controls the function of the seed wheel. The “HAND” button will place the seed wheel in the manual mode of operation. When the “HAND” button is pressed a window will appear (right), allowing the user to manually adjust the speed of the seed wheel. The “OFF” button will turn the associated device in the “OFF” mode of operation. The “AUTO” button will place the device in the automatic mode of operation. The motor will not operate in this function unless all other devices are in the “AUTO” mode and the “STARTUP” button is pressed on the main menu.

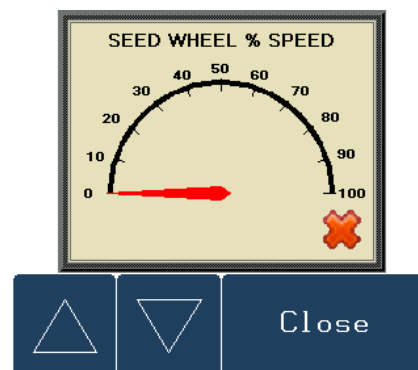

**4. Inlet Conveyor Control Module:** This module controls the function of the inlet conveyor. The “HAND” button will place the inlet conveyor in the manual mode of operation. The “OFF” button will turn the associated device in the “OFF” mode of operation. The “AUTO” button will place the device in the automatic mode of operation. The inlet conveyor will run in this function unless the supply hopper becomes full and activates the top proximity switch. The conveyor will remain off until the proximity switch has been deactivated, then the conveyor will start back up.

**5. Outlet Conveyor Control Module:** This module controls the function of the outlet conveyor. The “HAND” button will place the outlet conveyor in the manual mode of operation. The “OFF” button will turn the associated device in the “OFF” mode of operation. The “AUTO” button will place the device in the automatic mode of operation. The motor will not operate in this function unless all other devices are in the “AUTO” mode and the “STARTUP” button is pressed on the main menu.

## H-O-A Button Descriptions

**6. Pump Control Modules:** These modules control the function of the pumps. The “HAND” button will place the desired pump in the manual mode of operation. When the “HAND” button is pressed a second time, a window will appear (below) which will allow the operator to manually control the speed of the desired pump. The “OFF” button will turn the associated device in the “OFF” mode of operation. The “AUTO” button will place the device in the automatic mode of operation. The pump will not operate in this function until the “STARTUP” button is pressed on the main screen.

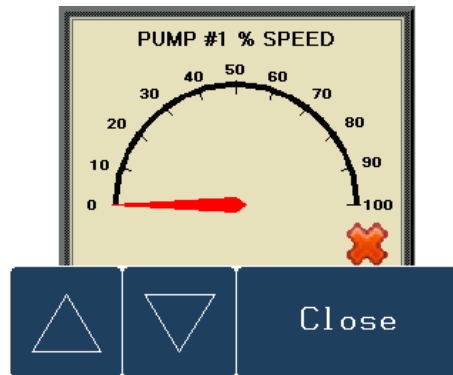

**7. Screen “EXIT” Button:** This button is used to exit back to the previous screen. Its functionality is the same throughout the HMI display.

**8. Atomizer Percent Speed:** When this button is pressed, a numeric touch pad (right) will appear to allow the operator to manually adjust the speed of the atomizer.

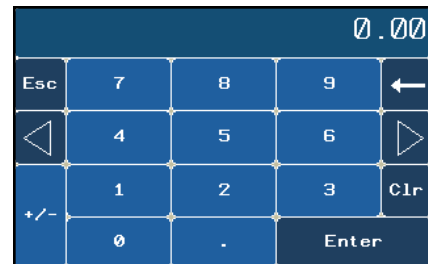

**9. Auxiliary Control:** This module allows the operator to control any unit which is plugged into the auxiliary port located on the bottom of the junction box located on the seed treater. The “HAND” button will allow the user to operate the unit in the manual mode of operation. The “OFF” button will disconnect control to the auxiliary port. The “AUTO” button will place the unit in the automatic mode of operation. Any unit plugged into the auxiliary port will not operate in this function until the “STARTUP” button is pressed on the main screen.



*Auxiliary Port*

**10. Seed Wheel RPM Display:** This display shows the actual RPM of the seed wheel and is used mainly for troubleshooting.

**11. “PRIME TO ATOMIZER” Button:** Used before a controlled startup to “preload” chemical in the tubing leading to the atomizer. To operate this button, place the atomizer and any pump that will be used in the “AUTO” mode. Next press and hold the “PRIME TO ATOMIZER” button. The atomizer and pumps will turn on and the liquid will be directed to the atomizer. The atomizer and pumps will run as long as the button is being pressed. When the button is released the atomizer and pumps will shut-off.

**12. Mix Tank Control Modules:** These modules control the function of the mix tanks. The “HAND” button will place the associated mix tank to “ON”. The “OFF” button will turn the associated device in the “OFF” mode of operation.

**13. “REVERSE” Button:** Allows the operator to reverse the pump direction and pump the product back into the mix tank. When the pump is on, it will display the actual pump flow rate.

**14. Air Valve Control Module:** This module controls where liquid is diverted for each pump. When a desired pump is placed in the “HAND” mode, the “RECIRC.” button will appear next to that pump control module. In this mode, liquid is pumped out of its desired tank, through the air actuated 3-way valve manifold and back into the mix tank. When the “RECIRC.” button is pressed, the icon will change to “PROCESS”. In this mode, liquid is diverted from the top of the tank, to the atomizer. When the “OFF” button is pressed the pump will go back to “RECIRC.” When the pump is placed in the “AUTO” mode the Air Valve Control cannot be accessed.

### UTILITIES SCREEN

This screen allows the operator to set various system parameters and gives access to the “Reports”, “Product Selection”, “Security”, “Alarms” and Information screens.

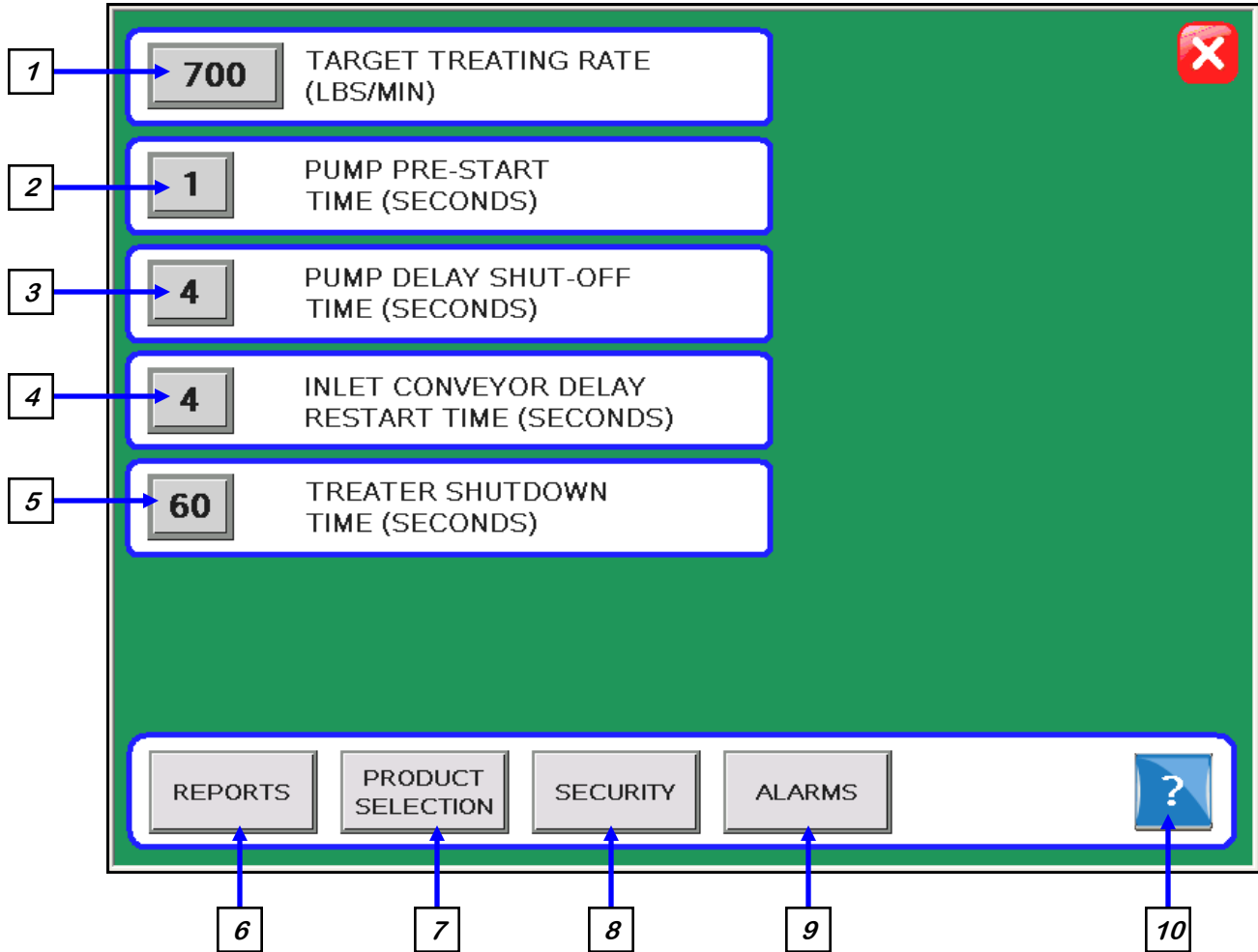

**NOTICE** When buttons 1-5 are pressed, a numeric touch pad (right) will appear allowing the operator to enter a number for that particular parameter.

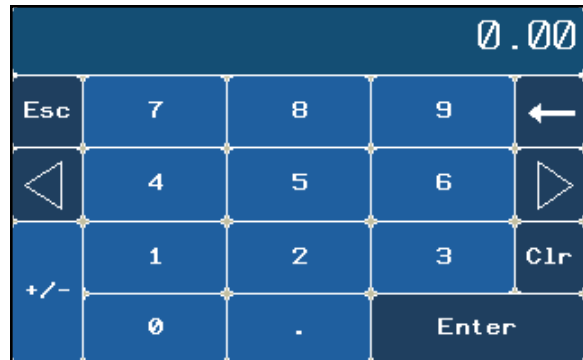

## **Utilities Screen Button Descriptions**

**1. TARGET TREATING RATE:** Pressing this button allows the operator to adjust the estimated treating rate in pounds per minute. This number is used by the system to control the rate of the Seed Wheel and Pumps. Maximum treating rate is 800 pounds per minute.

**2. PUMP PRE-START TIME:** Pressing this button allows the operator to adjust the start time of the pumps after the “STARTUP” button has been pressed on the main screen. This number will allow the 3-way air actuated valve to kick open and begin sending liquid to the seed treater a certain number of seconds before the seed wheel will turn on. This will help prevent any untreated seed at the beginning of a run.

**3. PUMP DELAY SHUT-OFF TIME:** Pressing this button allows the operator to adjust the delay shut-off time of the pumps after the proximity switches located in the seed wheel do not detect anymore seed.

**4. INLET CONVEYOR DELAY RESTART TIME:** Pressing this button allows the operator to adjust the restart time of the inlet conveyor after the top proximity switch no longer detects seed.

**5. TREATER SHUTDOWN TIME:** Pressing this button allows the operator to adjust the delay shutdown time of the seed treater after the “SHUTDOWN” button has been pressed after a run. This time will allow the seed treater and any conveyor to completely clean out.

**6. REPORTS:** This button advances the operator to the Reports screen.

**7. PRODUCT SELECTION:** This button advances the operator to the Product Selection screen.

**8. SECURITY:** This button advances the operator to the Security screen.

**9. ALARMS:** This button advances the operator to the Alarms screen.

**10. Information:** This button advances the operator to the information screen where the operator can find vital information on storage and troubleshooting.



**SECURITY SCREEN**

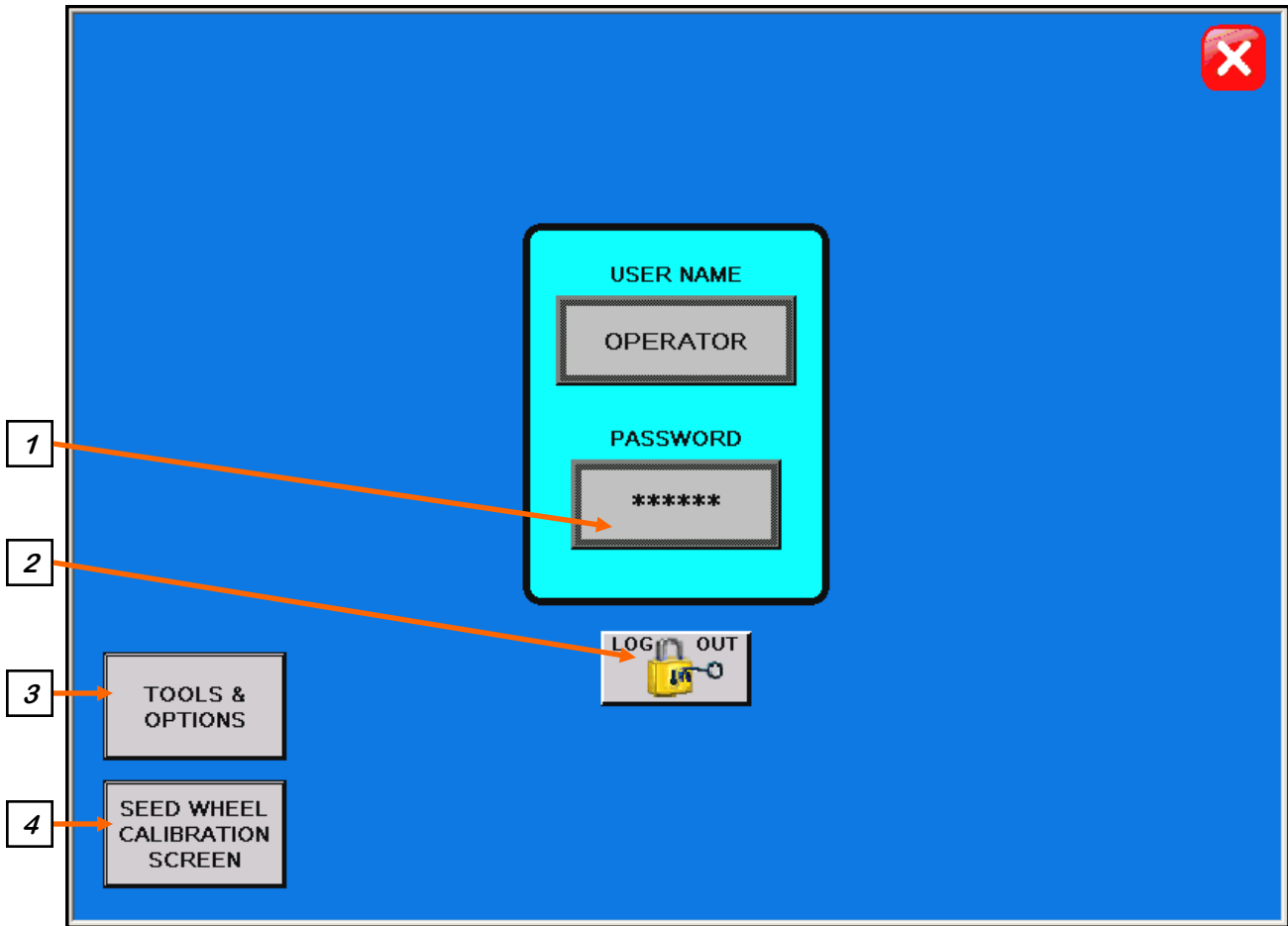

**Security Screen Button Descriptions**

**1. "PASSWORD" Entry:** The operator uses this input to obtain access to ALL options on this screen. When this button is pressed a keypad (right) will appear on the screen. The pass-code is "**USC**" and should only be made accessible to personnel qualified to operate the seed treater. The User Name will stay "OPERATOR"





**TOOLS & OPTIONS SCREEN**

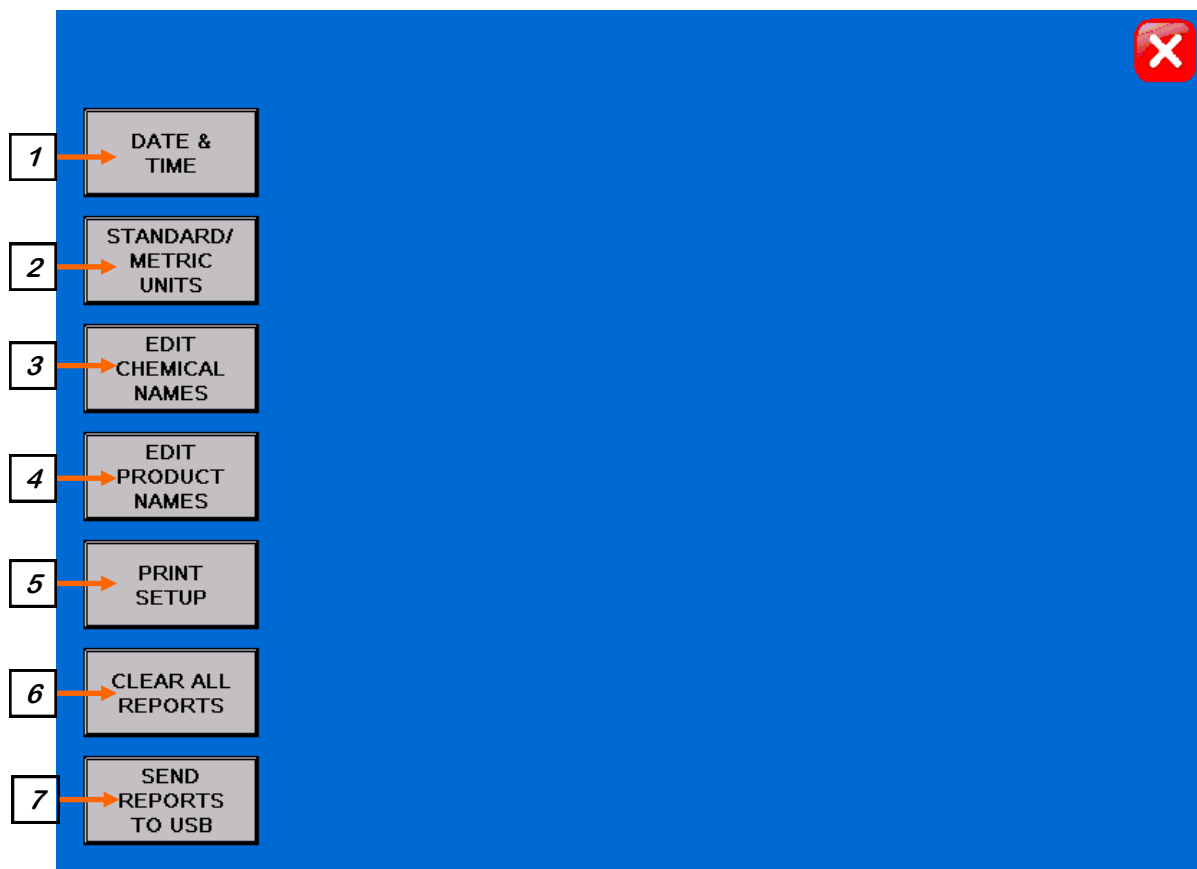

**Tools & Options Screen Button Descriptions**

**1. DATE & TIME:** This button advances the operator to a screen where the date and time can be changed. (right)

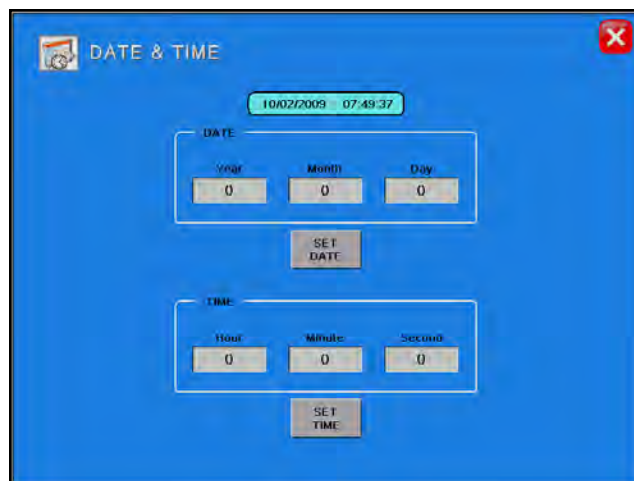

**Tools & Options Button Descriptions (continued)**

**2. STANDARD/METRIC UNITS:** Allows the operator to switch between Standard or Metric units of measurement. When this button is pressed a window will appear (below) which will allow the operator to select the desired units of measurement.

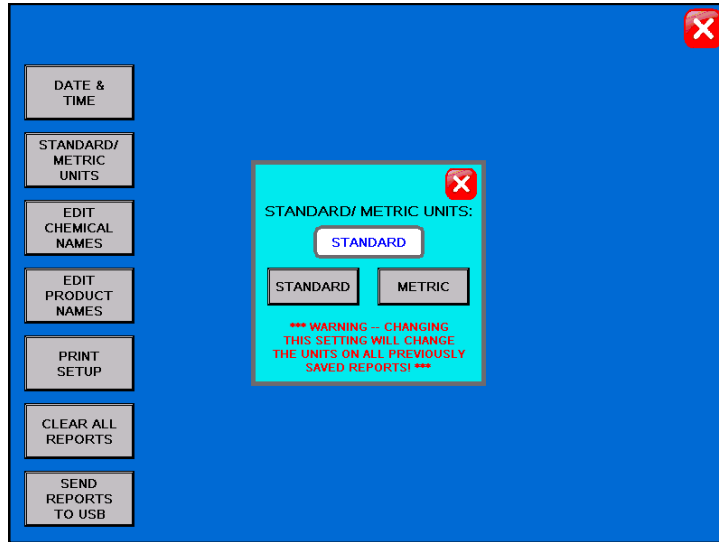

**3. EDIT CHEMICAL NAMES:** Allows the operator to change the chemical names to better fit their needs. Pressing the button will advance the operator to the screen below. By selecting one of the chemical types, the operator can change the name of the chemical.

*Press this button to adjust the name of the chemical.*

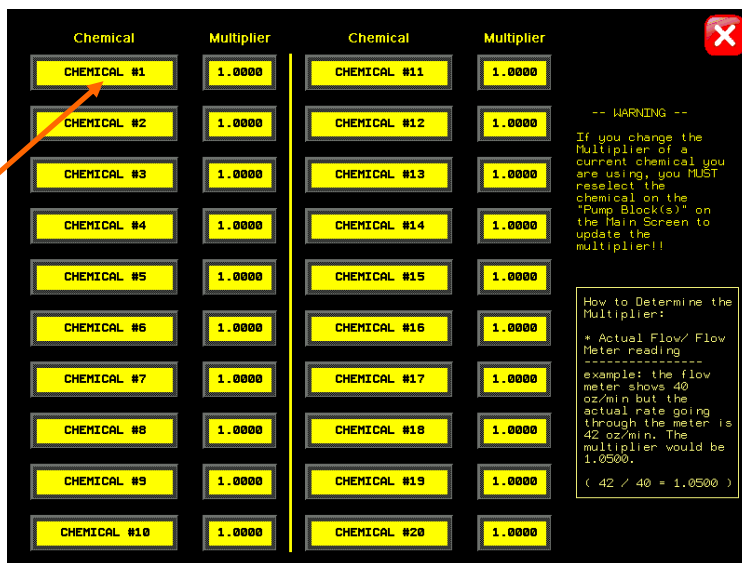

**3. EDIT CHEMICAL NAMES (CONTINUED):** This screen also allows the operator to recalibrate the flow meter by adjusting the multiplier for each chemical.

Chemical	Multiplier	Chemical	Multiplier
CHEMICAL #1	1.0000	CHEMICAL #11	1.0000
CHEMICAL #2	1.0000	CHEMICAL #12	1.0000
CHEMICAL #3	1.0000	CHEMICAL #13	1.0000
CHEMICAL #4	1.0000	CHEMICAL #14	1.0000
CHEMICAL #5	1.0000	CHEMICAL #15	1.0000
CHEMICAL #6	1.0000	CHEMICAL #16	1.0000
CHEMICAL #7	1.0000	CHEMICAL #17	1.0000
CHEMICAL #8	1.0000	CHEMICAL #18	1.0000
CHEMICAL #9	1.0000	CHEMICAL #19	1.0000
CHEMICAL #10	1.0000	CHEMICAL #20	1.0000

-- EDITING --  
 If you change the Multiplier of a current chemical you are using, you MUST reselect the chemical on the "Pump Block(s)" on the Main Screen to update the multiplier!!  
  
 How to Determine the Multiplier:  
 \* Actual Flow/ Flow Meter reading -----  
 example: the flow meter shows 40 oz/min but the actual rate going through the meter is 42 oz/min. The multiplier would be 1.0500.  
 ( 42 / 40 = 1.0500 )

*Press this button to adjust the multiplier for this chemical.*

**4. EDIT PRODUCT NAMES:** Allows the operator to change the product names to better fit their needs. Pressing the button will advance the operator to the screen below. By selecting one of the seed types, the operator can change the name of the product and the current calibration setting for the seed wheel.

**EDIT PRODUCT NAME**

Select the product you wish to rename.

CORN	WHEAT
COTTON	(OTHER)
PEAS	(OTHER)
RICE	(OTHER)
SOYBEANS	(OTHER)

\*\*\* When changing product names, the operator must calibrate the treater using the new product. Otherwise, the new product will retain the calibration of the previous product. \*\*\*

**Tools & Options Button Descriptions (continued)**

**5. PRINT SETUP:** Allows the operator to set up their personal company information which will be printed at the top of each report. Pressing the button will advance the operator to the screen below. The company information can be entered by selecting the blank space under each heading.

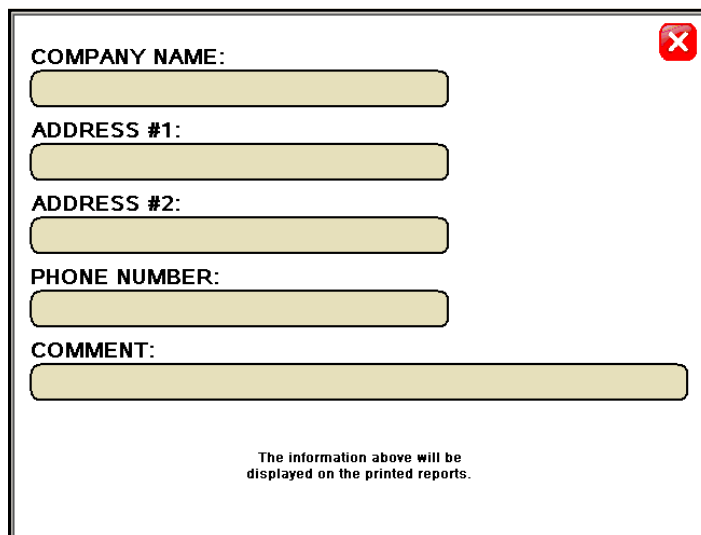

COMPANY NAME:  
 ADDRESS #1:  
 ADDRESS #2:  
 PHONE NUMBER:  
 COMMENT:

The information above will be displayed on the printed reports.

**6. CLEAR ALL REPORTS:** Pressing this button will open a window which will ask the operator if he or she wants to clear all the saved reports. If “YES” is pressed then the reports will be permanently erased.

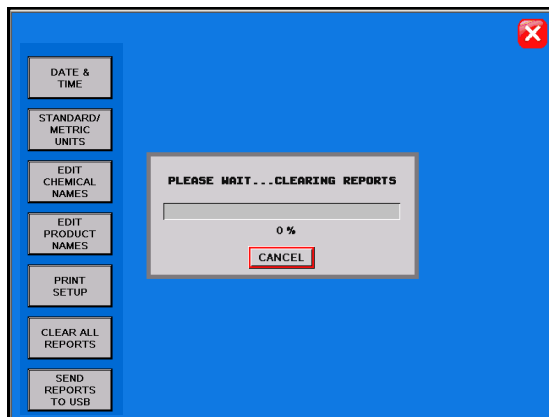
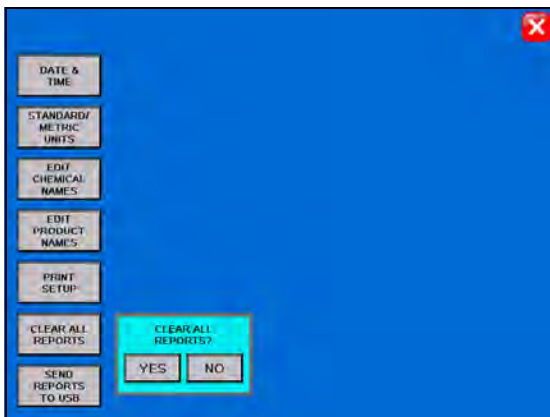

**7. SEND REPORTS TO USB:** If a memory stick is present in the USB port, this button can be pressed and all the saved reports will be downloaded to the memory stick.

SECTION  
E**CALIBRATION****SEED FLOW CALIBRATION**

The following is a list of steps to use when calibrating the seed flow. A seed calibration cup, funnel, stand, and scale are used to calibrate the seed wheel.

1. Set the empty seed calibration cup on the scale and zero the out the weight of the cup.
2. Place the funnel and stand in the seed to be treated. This will help to avoid any unnecessary clean-up while filling and leveling the top of the seed calibration cup.
3. Place your hand under the bottom of the funnel and fill the funnel up with seed.
4. Place the calibration cup under the funnel stand and remove your hand from the bottom of the funnel, and allow the cup to be filled. (figure 1)
5. After the cup has been filled, strike off the top of the calibration cup with a straight edge. (figure 2)

*Seed Calibration Cup*

**NOTICE** Do not shake the cup.

6. Weigh the sample of seed. (figure 3)

**NOTICE** A typical weight of the sample of seed will be anywhere between 2.8 to 4.0 lbs. Anything over or under this range could be caused by not zeroing out the weight of the cup, or the scale may be set on the wrong units.

*Figure 1**Figure 2**Figure 3*

- Take the weight of the seed sample and enter it into the main screen under “CUP WEIGHT”.

*Enter Seed Sample Weight Here*

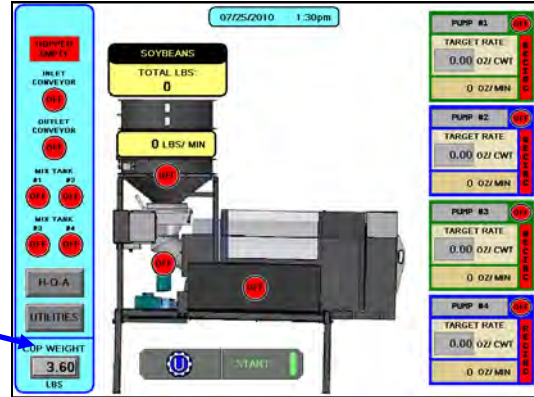

- Press the Utilities button on the main screen to advance to the utilities screen. Enter in the Target Treating Rate in pounds per minute. Maximum treating rate is 800 pounds per minute. Also at this time fill in all other parameters on this screen. Below is a screen shot of the utilities screen with typical numbers to use when beginning to treat.

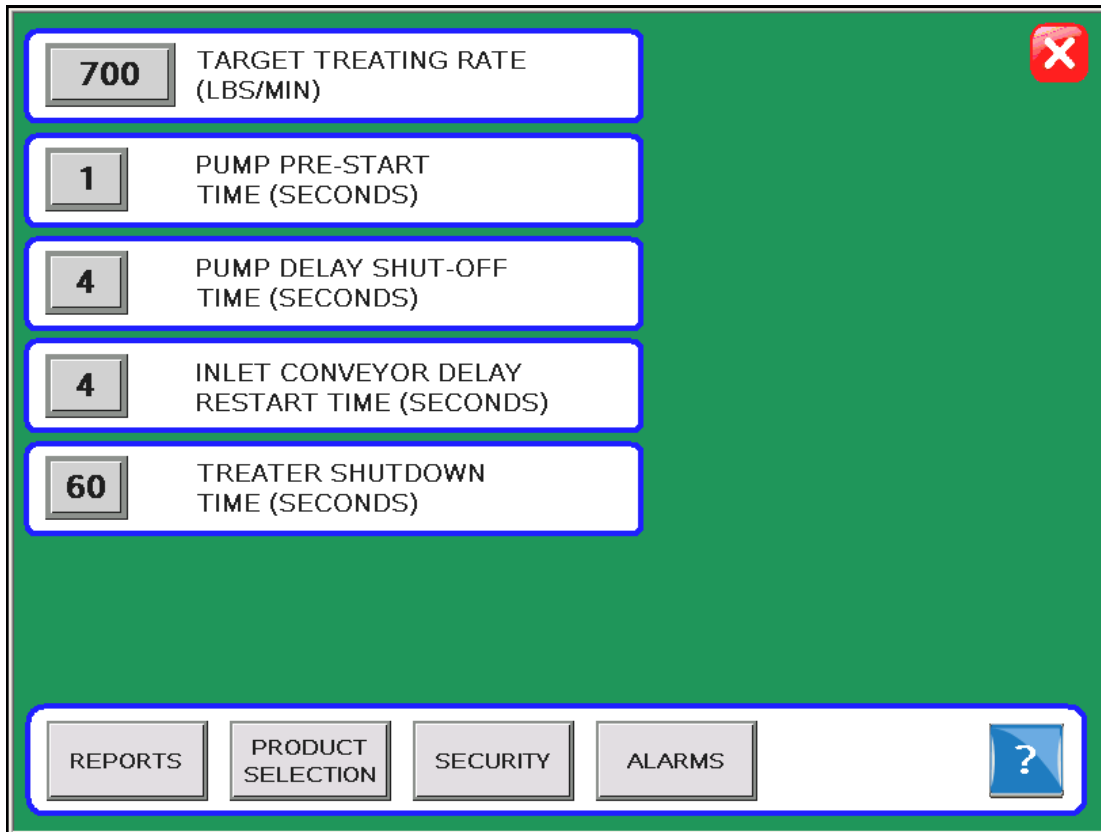



- Next, press the “PRODUCT SELECTION SCREEN” button to advance to the product selection screen. Select the type of seed you will be treating. A confirmation window will appear to confirm the selection. If you are treating a seed that doesn't appear on the screen then select “OTHER”.

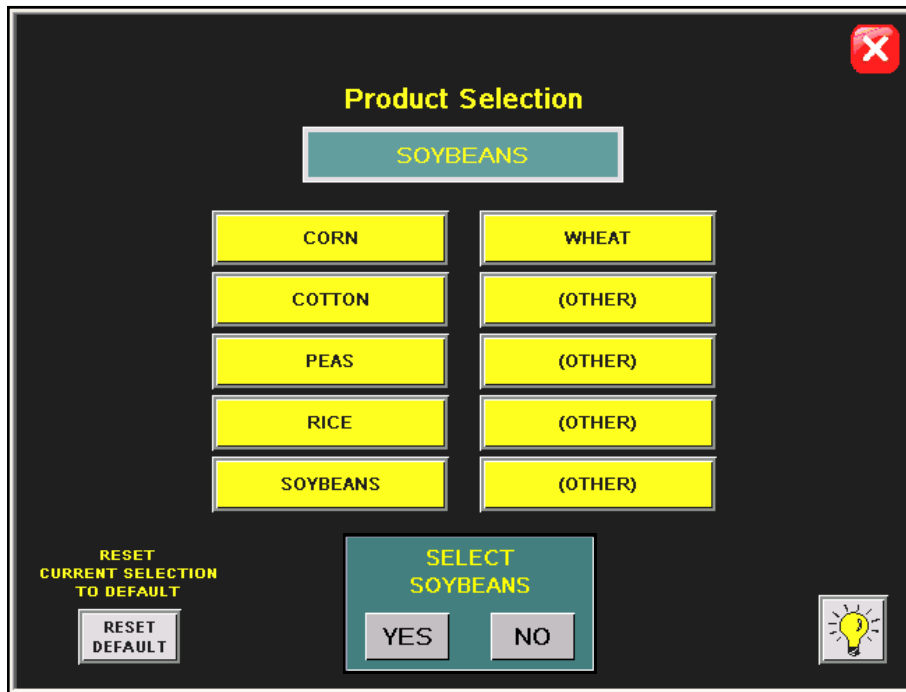

## PUMP CALIBRATION

1. Lock down the pump tubing in the pump head. (page 20)
2. Premix enough liquid for the amount of seed you are treating and pour into the 50 gallon stainless steel tank. It's always a good practice to mix up 20% extra slurry to help fill all the lines.

3. Under the H-O-A screen, press the "HAND" button for the desired mix tank to allow the liquid to mix.

*Mix Tank  
"Hand" Buttons*

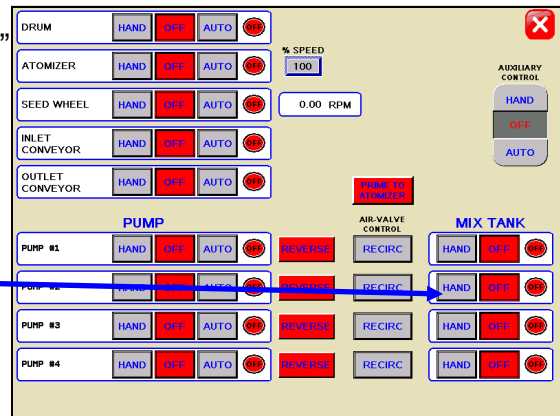

4. Enter into the main screen the number of ounces needed per hundred pounds of seed. This number will be typed in by pressing the grey box underneath "TARGET RATE". Then choose the type of chemical you will be applying by pressing the grey box located above "TARGET RATE" and choosing the correct chemical from the chemical list.

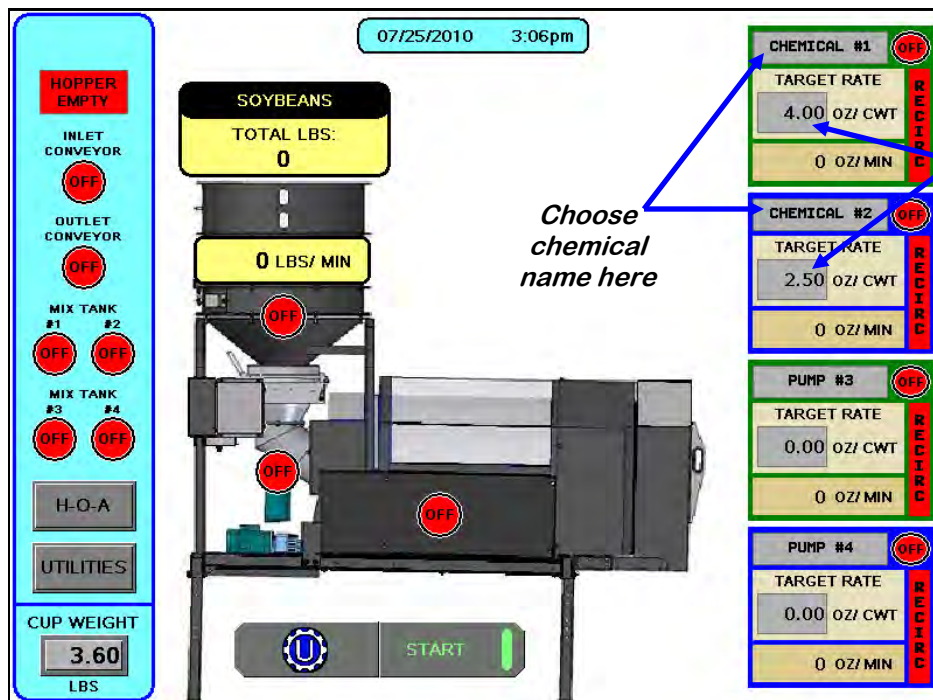

*Choose  
chemical  
name here*

*Enter in  
Ounces per  
cwt. here*

## FLOW METER CALIBRATION

Due to the composition of some types of chemicals, additional flow meter calibration may be required. It is recommended that, like other calibration devices, the flow meter(s) is checked regularly and calibrated when needed. When calibrating the flow meter(s), each chemical slurry must be checked and adjusted for.

1. To begin the calibration process, fill the appropriate mix tank with the slurry that is going to be used for this calibration.
2. Turn the corresponding pump to the hand position and adjust the flow rate until it reads about 20 percent on the pump control module (right). Let the system run in recirculation mode for 15 minutes. This will remove any air from the system.
3. Place a measuring cup below the “MIX TANK/CALIBRATION TUBE” valve that is located on top of the mix tank (right). Using a stopwatch, place the valve to the “calibration tube” position and begin timing for one minute. When one minute is up, place the valve back in the “mix tank” position. Note the total ounces of chemical that is in the calibration tube. Also, note the reading on the flow meter while the calibration test is being performed.
4. Take the amount of liquid in the calibration tube (ounces) and divide it by the flow meter reading to find the flow meter multiplier.
5. Once the multiplier has been found, enter it into the box for the corresponding chemical in the “Security” section of the program. This box is located to the right of the chemical name box in the “Edit Chemical Names” screen.
6. Exit to the main screen and re-select the chemical name to set the new multiplier and ensure proper calibration on this chemical. The multiplier will not show up on the screen but will be used by the system for calibration purposes.
7. Repeat the process as necessary and for each different chemical slurry used.

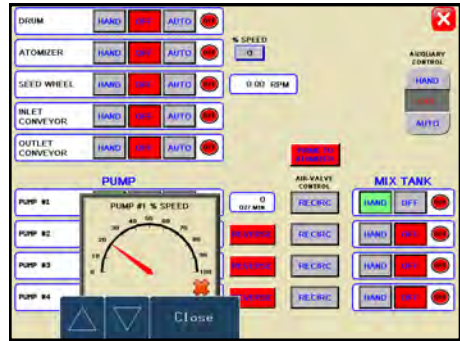

**Enter Multiplier Here**

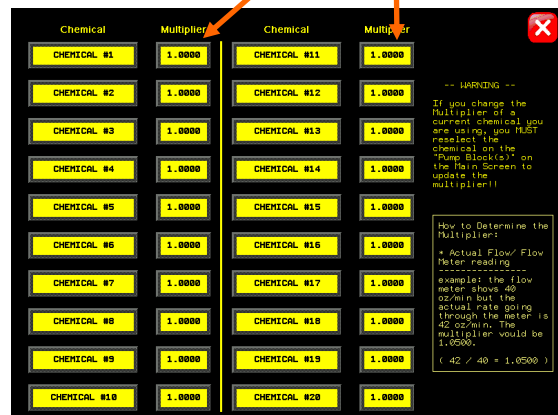

## TREATING SEED

1. Under the H-O-A Screen, place the “DRUM”, “ATOMIZER”, “SEED WHEEL”, “INLET CONVEYOR”, “OUTLET CONVEYOR”, and desired pumps in “AUTO”.
2. Next, prime the chemical line to the atomizer. Press and hold the “PRIME TO ATOMIZER” button. The atomizer will turn on and liquid will begin pumping up to the atomizer. When liquid reaches the atomizer, release the “PRIME TO ATOMIZER” button.

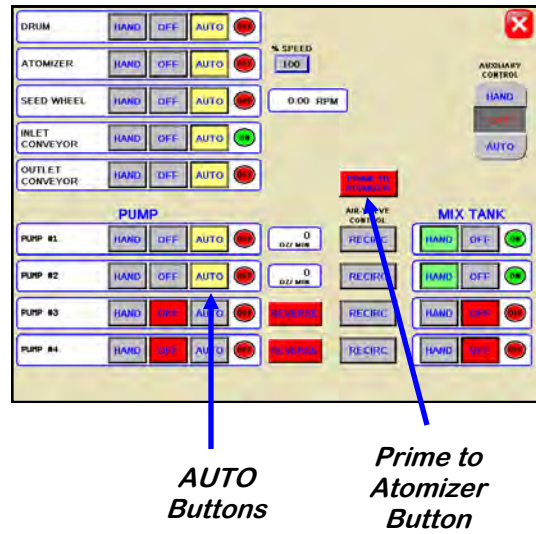

3. Advance back to the main screen and press the “STARTUP” button. The drum, atomizer, inlet conveyor and outlet conveyor will activate. The pump will turn on and re-circulate until it reaches the desired flow rate needed to match the target treating rate that was entered. Begin the flow of seed into the inlet conveyor. The inlet conveyor will then begin dumping seed into the seed wheel.

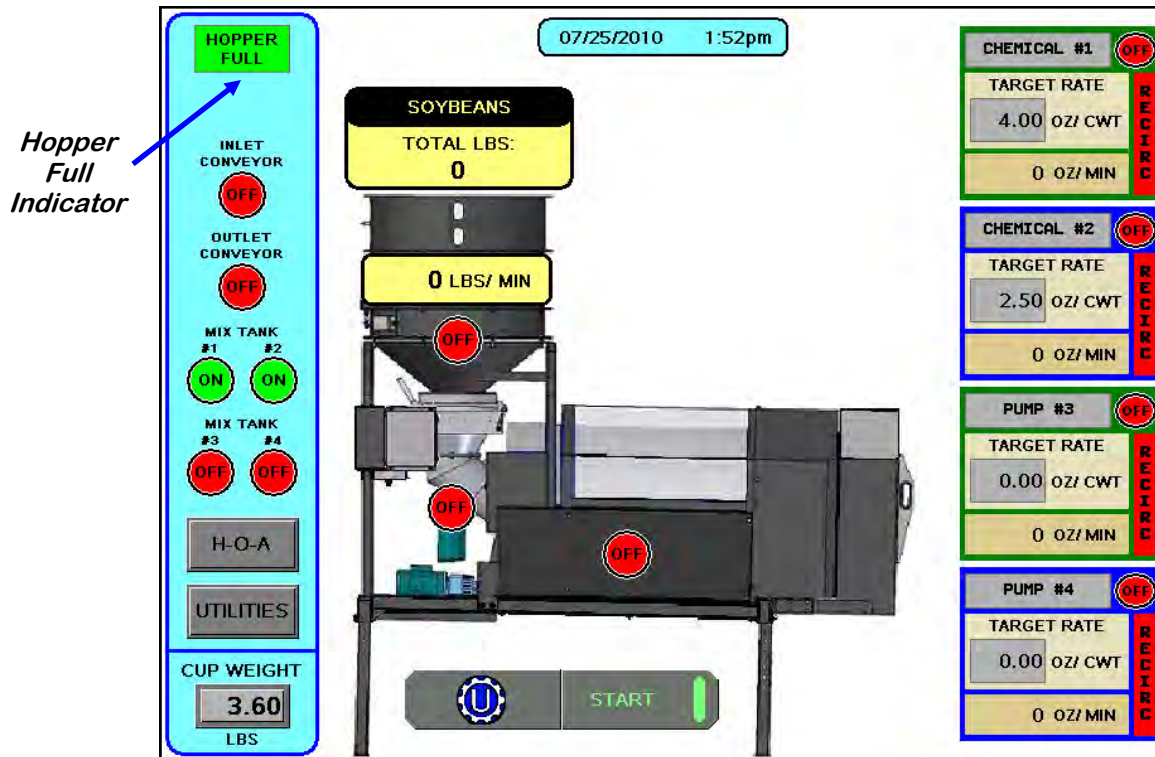

4. When the pumps flow rate has been reached and seed is covering the proximity sensors inside of the seed wheel, the air actuated 3-way valve will open and allow liquid to pump up to the atomizer. Simultaneously the seed wheel will turn on and the seed treating process will begin.
5. As the seed is being treated. The main screen will display the pounds per minute, the total pounds, and the liquid flow rate. If the system needs to be stopped for a moment because of a problem. The "PAUSE" button can be pressed to halt the process. When ready to begin again, the "CONTINUE" button is pressed.
6. When the seed wheel hopper is full the "HOPPER FULL" indicator light will come on and the inlet conveyor will shut off. The flow of seed into the treater will begin again once seed is no longer present at the top proximity sensor in the hopper.

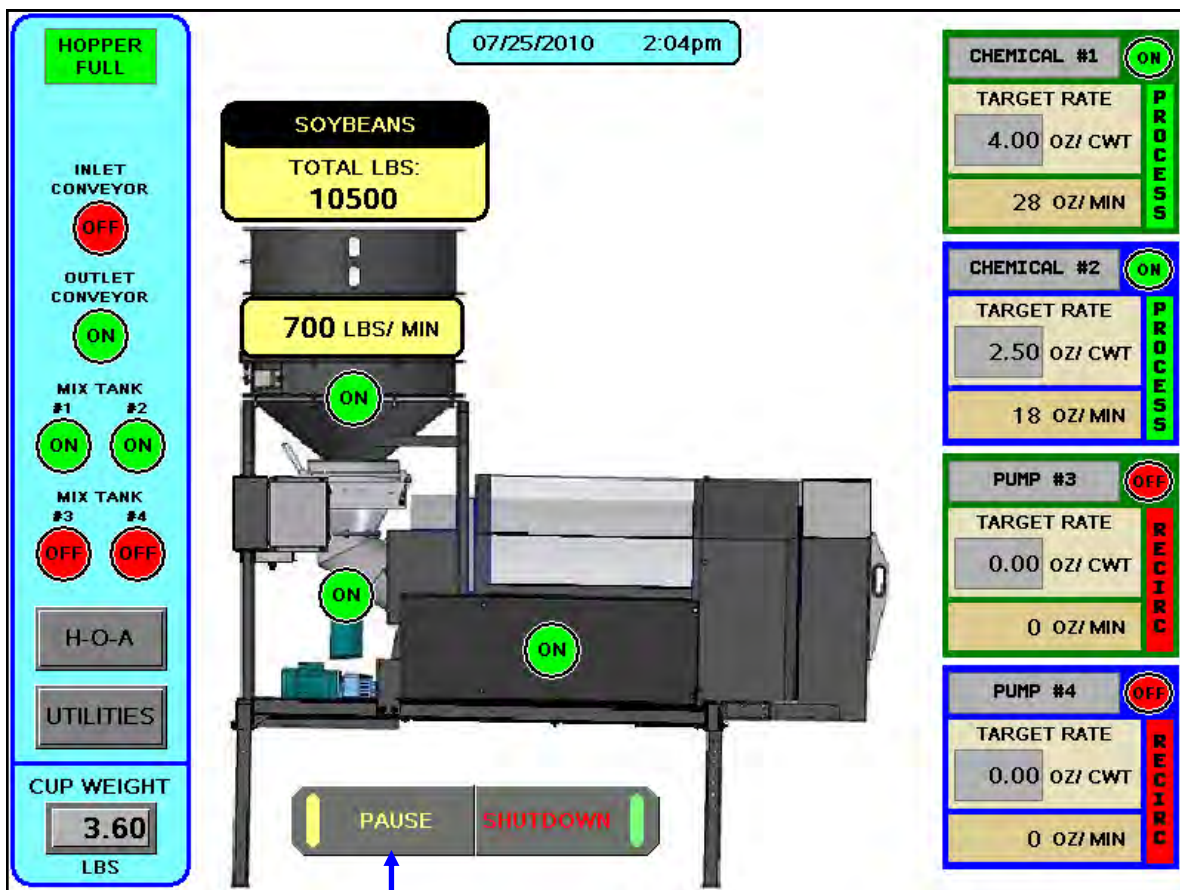

Pause Button

- When all seed passes through the seed wheel, the seed wheel will turn off and the pump will switch to recirculate. When more seed is fed into the treater, the treating process will continue.
- After all seed has been treated, the “SHUTDOWN” button can be pressed. After the button has been pressed, a window will appear notifying the operator that the system will shut down after a specified amount of time.



## REPORTS

The following steps explain how reports are entered after a run has been completed.

- After the “SHUTDOWN” button has been pressed, a dialog box will appear (right), notifying the operator that the data from the run is being saved.



- Once the data has been saved, the operator will be brought to a reports screen (left). Under the reports screen, the customers information and seed information can be recorded and saved for later use. Press the EDIT button to change the customer name, seed variety, and lot number. Pressing the cells next to each piece of information will bring up a keypad which will allow the operator to enter in the information. When finished the operator can press the “OK” button to save the data. The “PRINT” button can be pressed to print the data for the customers records. Then press the “X” in the top right corner of the screen to exit back to the main screen.

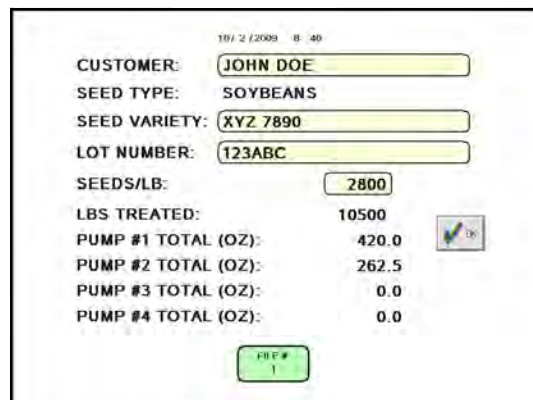
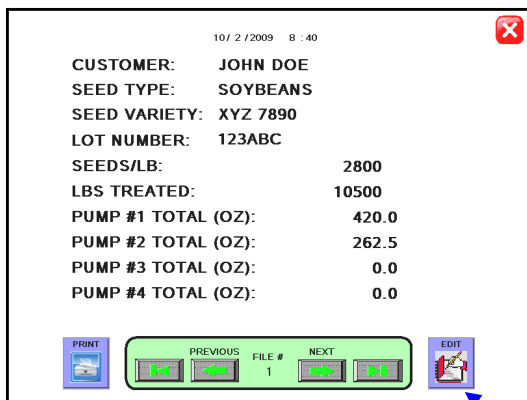

*Edit  
Button*

- Once the data has been saved, the reports can be accessed later through the Utilities screen (bottom left). Or if you would like to erase the reports, press the “SECURITY” button under the Utilities screen to advance to the Security Screen (bottom right). Enter in the Password of “**USC**”. The “CLEAR ALL REPORTS” button will appear allowing the operator to erase all saved reports.

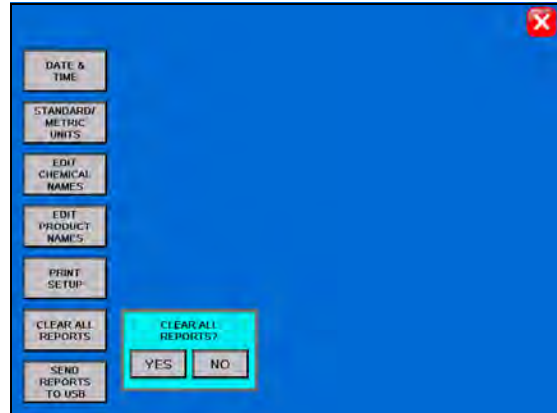
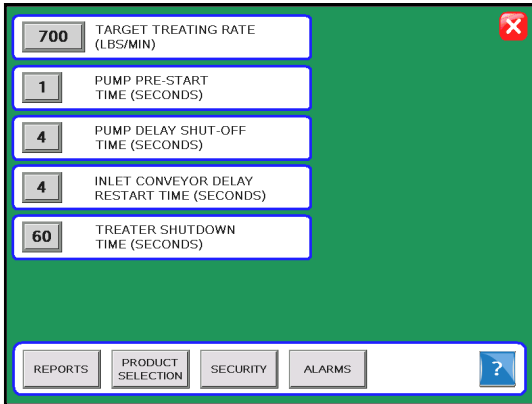

## SEED WHEEL CALIBRATION

1. If the totalized weight from the seed wheel differs from the actual weight of the seed that was ran through the treater. The seed wheel can be calibrated to increase accuracy. Press the Utilities button on the Main screen. Next, press the “SECURITY” button to advance to the Security Screen. Enter in the Password of “**USC**”, then press the Seed Wheel Calibration button. This will advance you to the Seed Wheel Calibration Screen.

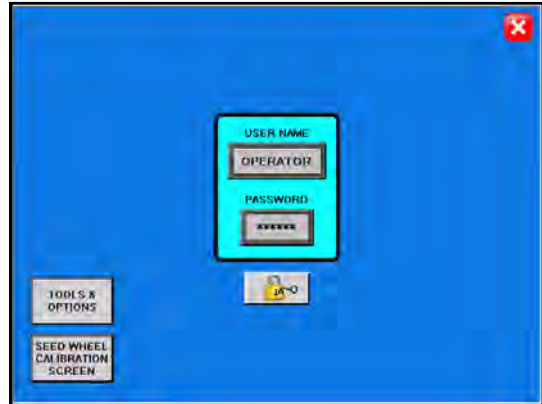

*Security Screen*

2. Enter in the “ACTUAL SCALE WEIGHT” of the seed that was treated, and the “TOTALIZER WEIGHT” from what the seed wheel recorded.
3. Press the “APPLY” button. The PLC will automatically calibrate the seed wheel and exit back to the Main screen.

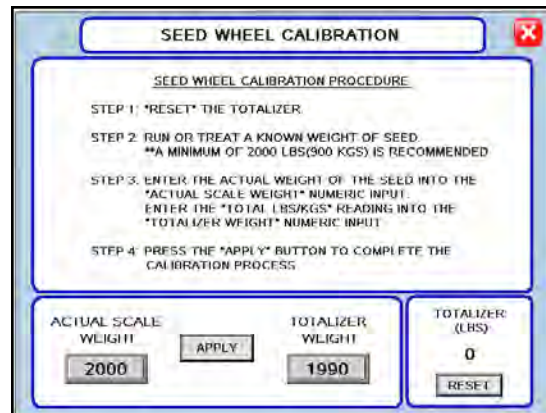

*Seed Wheel Calibration Screen*



## PRINTING & UPLOADING REPORTS

The USB port located on the side of the operator control panel, allows the operator to print reports or upload reports to a Compact Flash device.

When a printer is hooked to the USB port, the operator can print a report by pressing the print button located on the Report Screen.

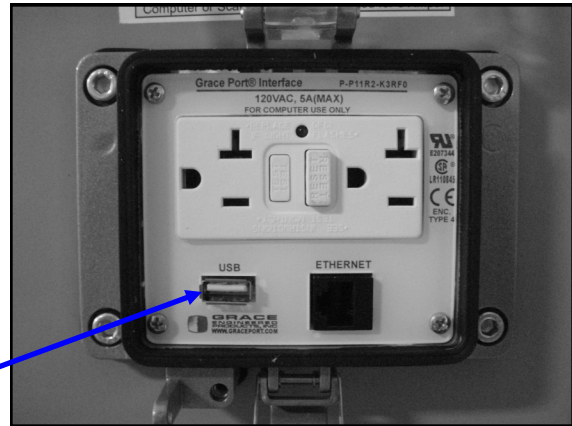

USB Port



10/ 2 /2009 8 : 40

**CUSTOMER: JOHN DOE**  
**SEED TYPE: SOYBEANS**  
**SEED VARIETY: XYZ 7890**  
**LOT NUMBER: 123ABC**

<b>SEEDS/LB:</b>	<b>2800</b>
<b>LBS TREATED:</b>	<b>10500</b>
<b>PUMP #1 TOTAL (OZ):</b>	<b>420.0</b>
<b>PUMP #2 TOTAL (OZ):</b>	<b>262.5</b>
<b>PUMP #3 TOTAL (OZ):</b>	<b>0.0</b>
<b>PUMP #4 TOTAL (OZ):</b>	<b>0.0</b>

**Print Button** →   

### Uploading Reports

Use the following steps to upload reports to a computer.

1. Insert a Compact Flash device into the USB port.
2. Advance to the Tools & Options screen.
3. Press the “SEND REPORTS TO USB” button. A confirmation window will appear. Press the YES button and all the reports will automatically copy to the compact flash device.

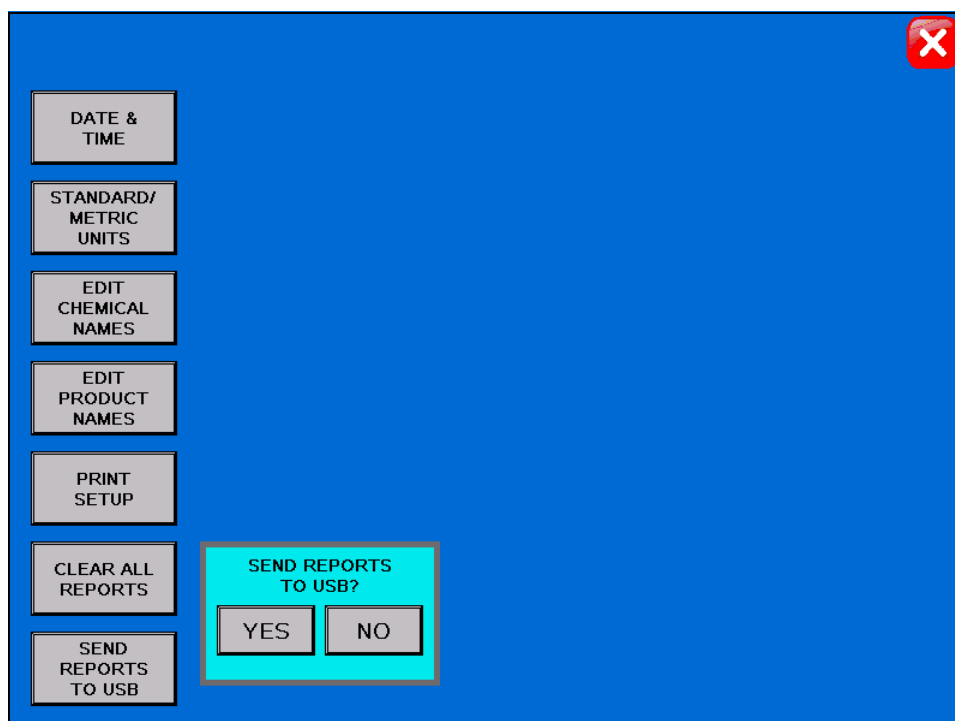

4. Remove the compact flash device from the control panel and insert into your computer.
5. Insert HMI Report Conversion CD into your computer and install the Report Converter Software to the computers hard drive.
6. Once the software has been downloaded, start Data Manager. In the Windows Start menu, point to Programs, Schneider Electric, Vijeo-Designer, Tools Data Manager, and click Vijeo-Designer Data Manager.

7. On the main page, use the Media drop-down list to select Local Files and then click Next.

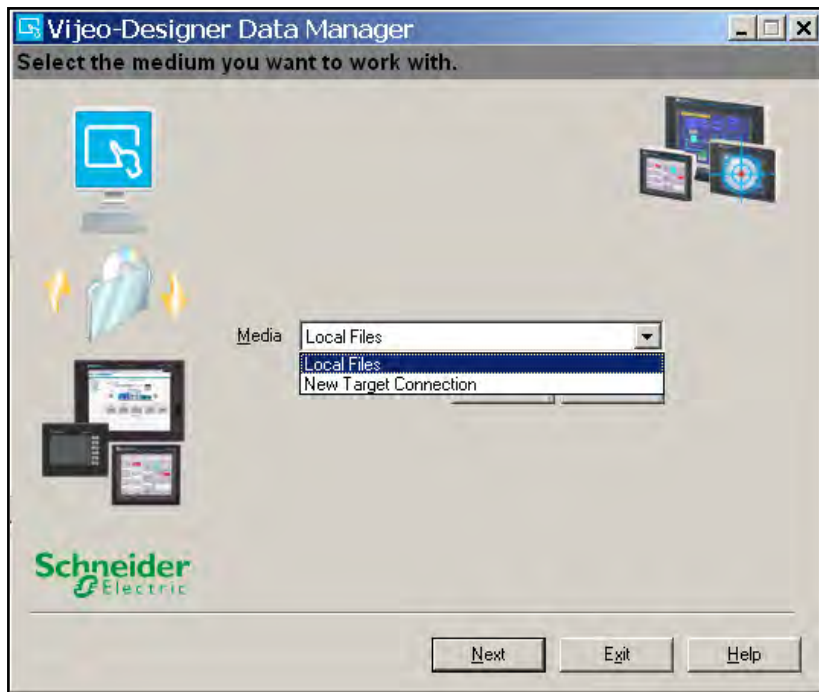

8. Select Convert Recipe or Data Logging Files and click Next.

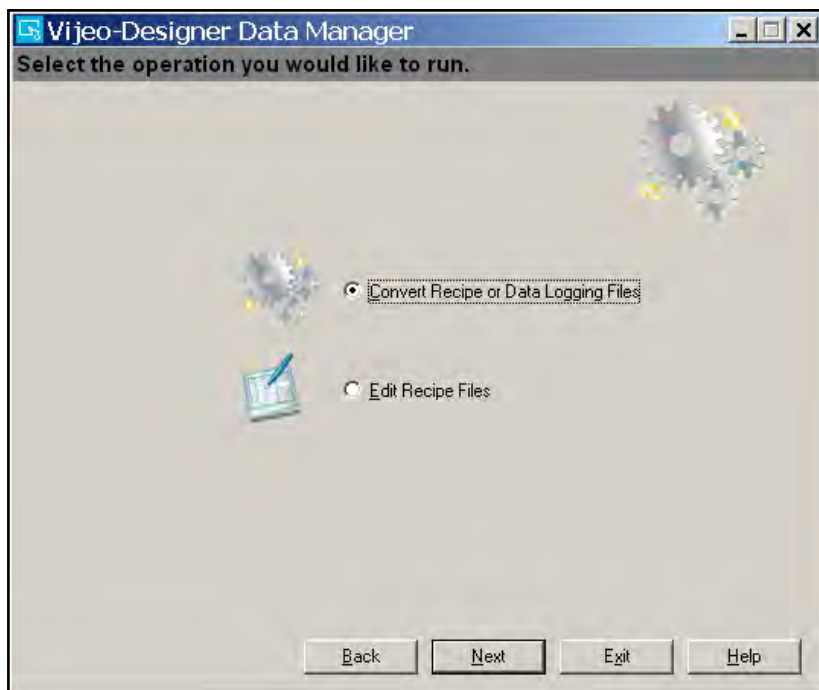

9. In the window to convert files, configure the conversion settings as required. The table below describes the conversion property settings.

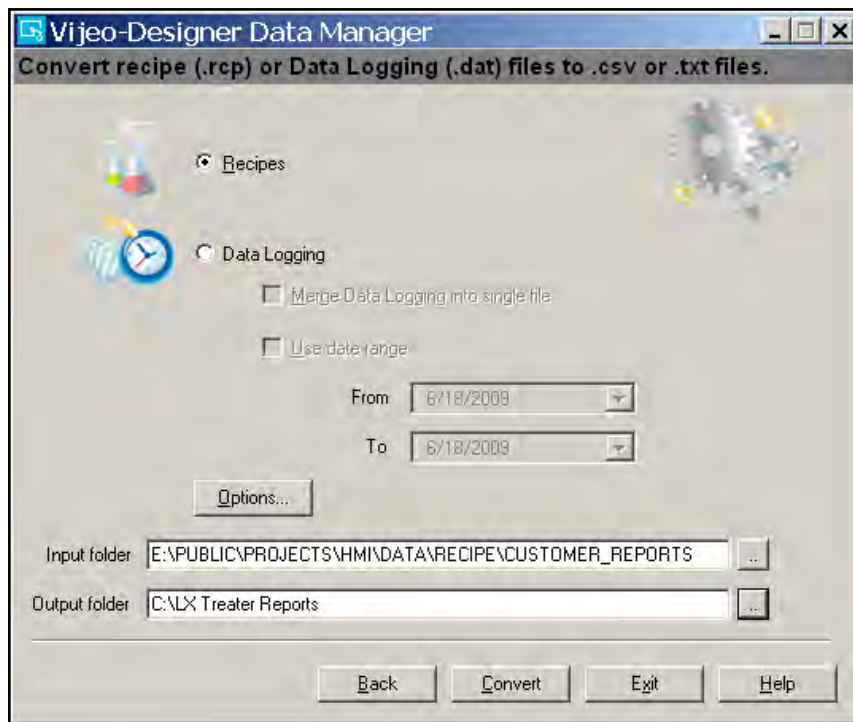

<b><u>PROPERTY</u></b>	<b><u>DESCRIPTION</u></b>
File Types	Select the file type for the Data Manager to convert Recipes (.rcp)
Input Folder	Specify the folder that contains the files to convert. Click the Input folder ellipsis button and use Windows Explorer to specify the Input folder. Alternatively, you can type the file path directly into the Input folder field. (The path above shows the folder structure that will appear on your USB drive.)
Output Folder	Specify the output folder for the converted files. Click the ellipsis button and use the Windows Explorer to select the output folder. Alternatively, you can type the file path directly into the Output Folder field.

- Click Convert to convert the files. The Data Transfer Status window appears and shows the conversion status.

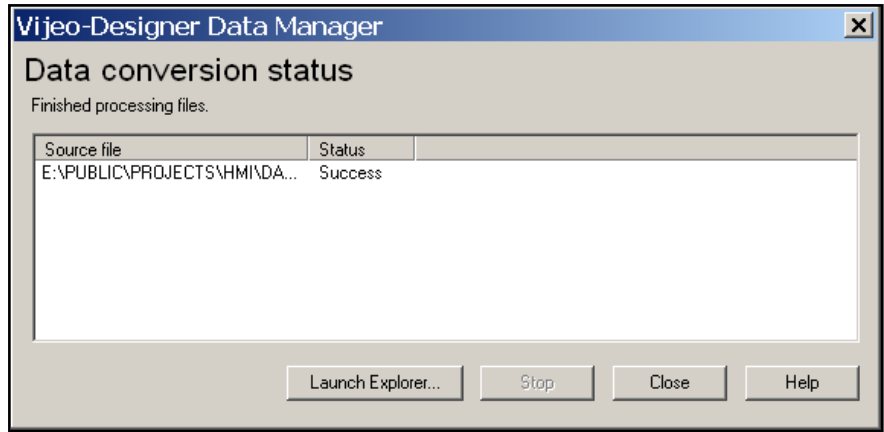

- To save converted (.csv) report files as Microsoft Excel files, start Microsoft Office Excel. In the File menu, click Open. In the Look in: drop-down list, browse to the folder you specified when converting the files. Use the Files of type: drop-down list to select "Text Files (\*.prn; \*.txt; \*.csv)." Select the file R00001.csv and click Open.

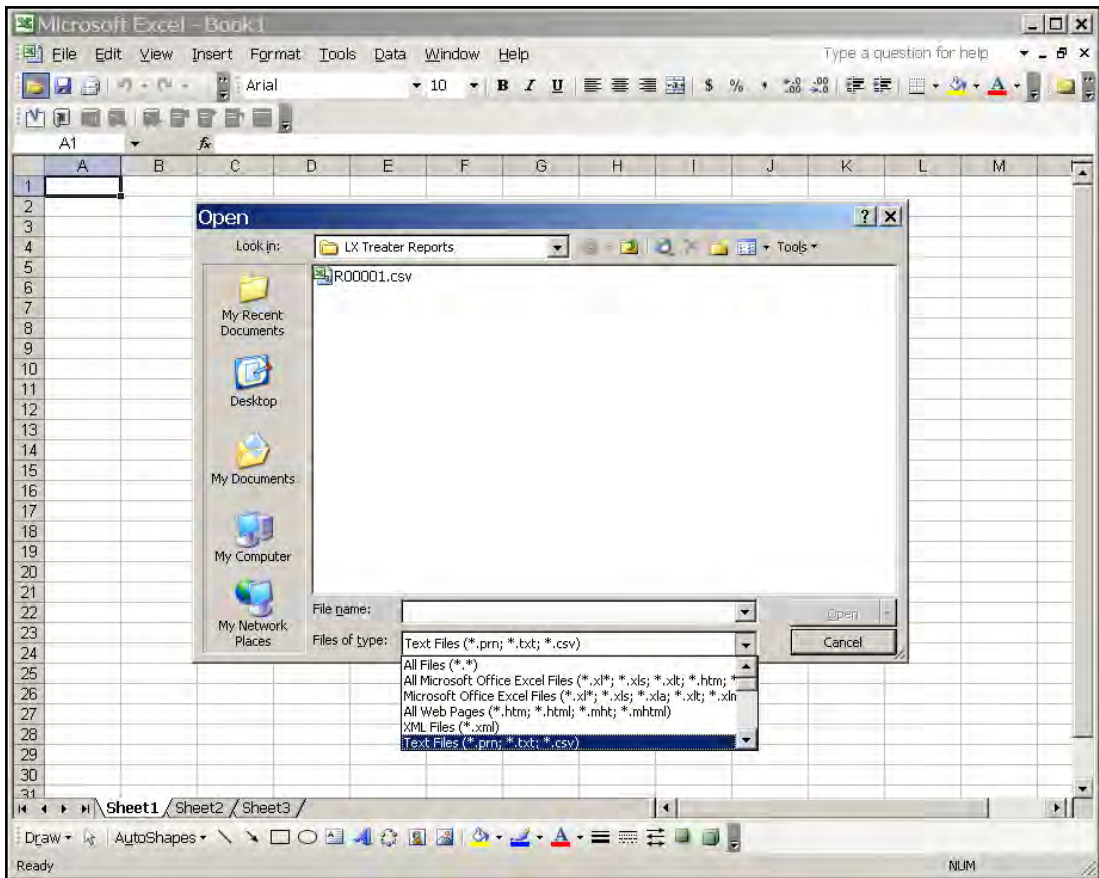

- The Text Import Wizard will open. Select Delimited as the Original data type, and enter "122" in the "Start import at row:" input. Click Next.

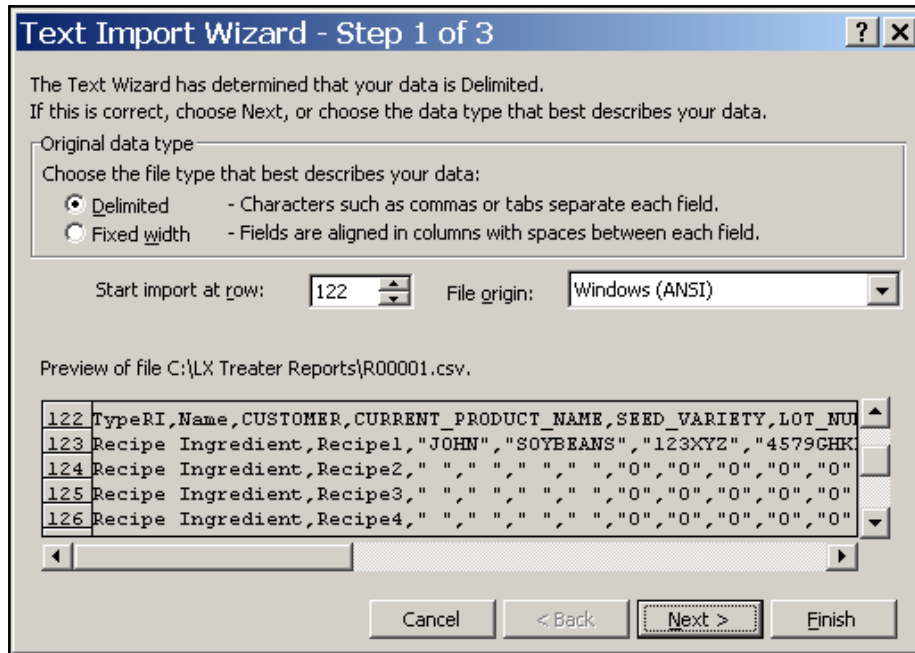

- Select "Comma" as the Delimiter and click Next.

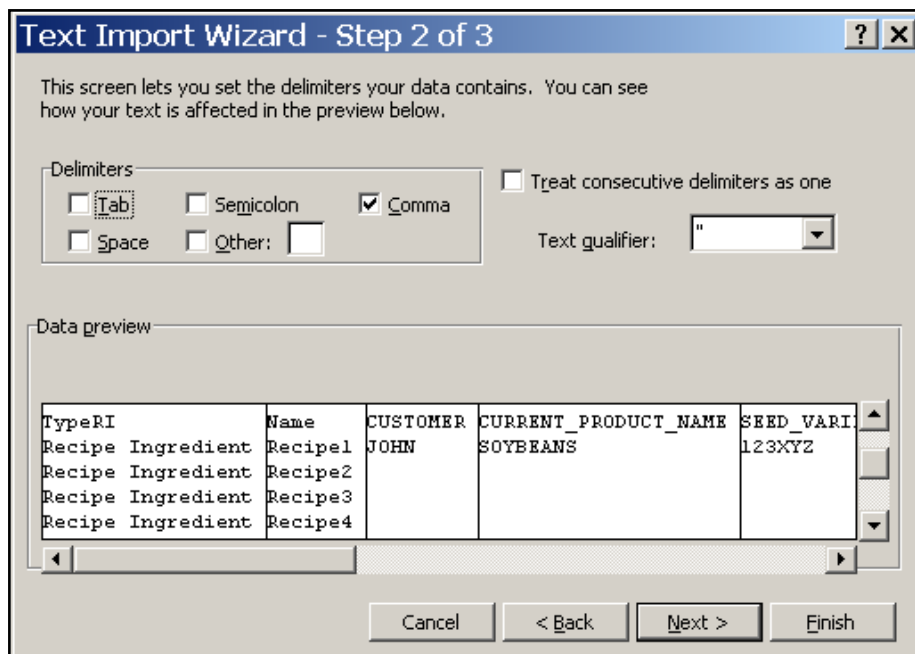

- Highlight the first column and select “Do not import column (skip)” from the Column data format area. Click Finish.

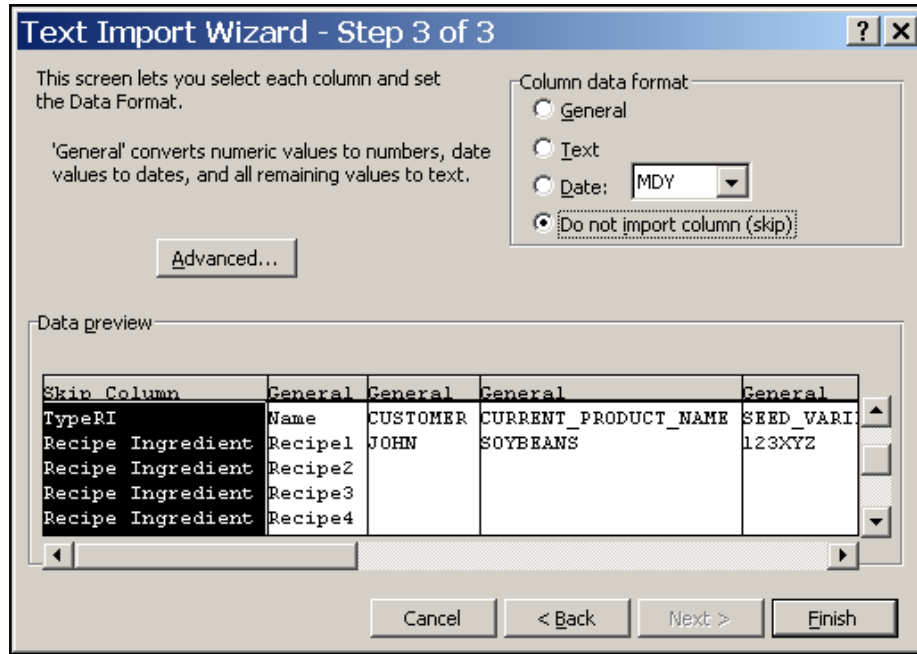

- The Report conversion process is complete. In the File menu, click Save As. In the Save as type: drop-down list select Microsoft Office Excel Workbook (\*.xls). Click Save. The data is now in Excel format and can be modified as needed.

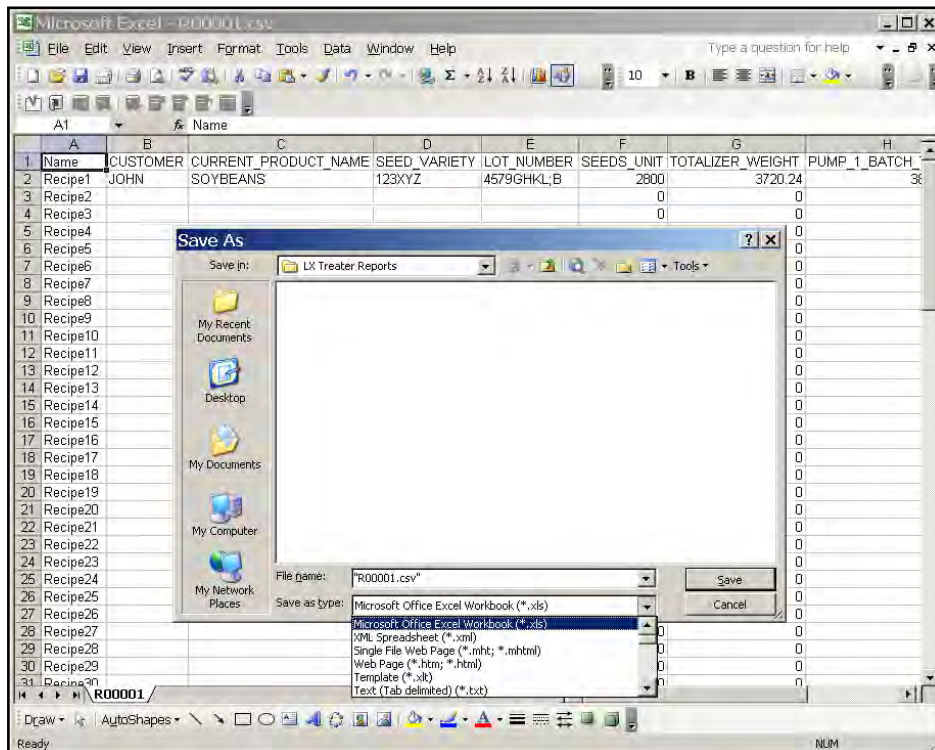

**SECTION  
F**

**TROUBLESHOOTING & ALARMS**

**TROUBLESHOOTING**

Below is a table describing the most frequent problems and solutions with the USC MX Series Seed Treater. For further assistance, contact your local USC dealer.

Problem	Possible Cause	Solution
Inlet Conveyor will not turn on.	<ol style="list-style-type: none"> <li>1. Inlet Conveyor proximity switch is activated.</li> <li>2. Inlet Conveyor proximity switch is too sensitive.</li> <li>3. Conveyor is plugged into wrong outlet on seed treater panel.</li> </ol>	<ol style="list-style-type: none"> <li>1. Clean proximity switch.</li> <li>2. Adjust the Inlet Conveyor proximity switch sensitivity by turning the adjustment screw counter-clockwise (page 58).</li> <li>3. Check to make sure the Inlet Conveyor is plugged into the inlet conveyor receptacle.</li> </ol>
Pump will not turn off in "AUTO" when seed runs out.	<ol style="list-style-type: none"> <li>1. Proximity switch is dirty.</li> <li>2. Proximity switch is set too sensitive.</li> </ol>	<ol style="list-style-type: none"> <li>1. Clean proximity switch.</li> <li>2. Adjust the pump proximity switch sensitivity by turning adjustment screw counter-clockwise (page 58).</li> </ol>
Pump will not turn on in "AUTO"	<ol style="list-style-type: none"> <li>1. Proximity switch is not staying covered.</li> <li>2. Proximity switch is not sensitive enough.</li> </ol>	<ol style="list-style-type: none"> <li>1. Make sure proximity switch is staying covered with seed.</li> <li>2. Adjust pump proximity switch sensitivity by turning the adjustment screw clockwise (page 58).</li> </ol>
Inlet conveyor won't shut off when supply hopper is full.	<ol style="list-style-type: none"> <li>1. Seed is not hitting proximity switch.</li> <li>2. Proximity switch is not set sensitive enough.</li> <li>3. Inlet Conveyor is plugged into wrong receptacle.</li> </ol>	<ol style="list-style-type: none"> <li>1. Make sure seed is hitting proximity switch.</li> <li>2. Adjust the inlet conveyor proximity switch by turning the adjustment screw clockwise (page 58).</li> <li>3. Make sure Inlet Conveyor is plugged inlet conveyor receptacle.</li> </ol>



Problem	Possible Cause	Solution
Pump is Fluctuating	<ol style="list-style-type: none"> <li>1. Restriction in tubing</li> <li>2. Filter is plugged or missing gasket.</li> </ol>	<ol style="list-style-type: none"> <li>1. Flush tubing and check filter for any restrictions.</li> <li>2. Clean filter and check for gasket.</li> </ol>
Seed Calibration is fluctuating	<ol style="list-style-type: none"> <li>1. Seed treater supply hopper is not staying full.</li> <li>2. Restriction in the supply hopper or seed wheel.</li> <li>3. Build-up in the atomizing chamber.</li> </ol>	<ol style="list-style-type: none"> <li>1. Make sure the supply hopper and seed wheel are staying full. May have to lower seed flow rate in order to have a consistent flow of seed.</li> <li>2. Check supply hopper and seed wheel for any debris, and remove.</li> <li>3. Remove atomizing housing and clean out any build-up of material.</li> </ol>
Drum is slipping and seed is coming out the inlet side of the drum.	<ol style="list-style-type: none"> <li>1. Drum is wet.</li> <li>2. The seed treater is set too level.</li> <li>3. Chains are too loose.</li> </ol>	<ol style="list-style-type: none"> <li>1. Dry off any moisture that may have collected on the outside of the drum.</li> <li>2. Adjust the slope of the seed treater to at least a 3" drop from front to back. If desired, more slope can be applied.</li> <li>3. Check and tighten the drive chains. Also check the chain alignment.</li> </ol>
None of the Motors will turn to "ON" in "HAND" mode	<ol style="list-style-type: none"> <li>1. Processor is faulted.</li> <li>2. Emergency Stop button is activated.</li> </ol>	<ol style="list-style-type: none"> <li>1. Disconnect power and wait 30 seconds before reconnecting power.</li> <li>2. Pull out the emergency stop button.</li> </ol>

## **PROXIMITY SWITCH ADJUSTMENT GUIDE**

The proximity switches mounted in the extension ring and the seed wheel detect when seed is present.

The proximity switch located in the extension ring is used to automatically shut off the inlet conveyor when the surge hopper is full. This proximity switch is not present on tower systems.

The proximity switches located in the seed wheel automatically shut off the pump when all seed has left the hopper.

If the proximity switch is not working properly, this can be caused by wear, dust, or even moisture. The first step is to clean the lens of the proximity switch. If this does not solve the problem, the next step would be to adjust the sensitivity of the proximity switch.

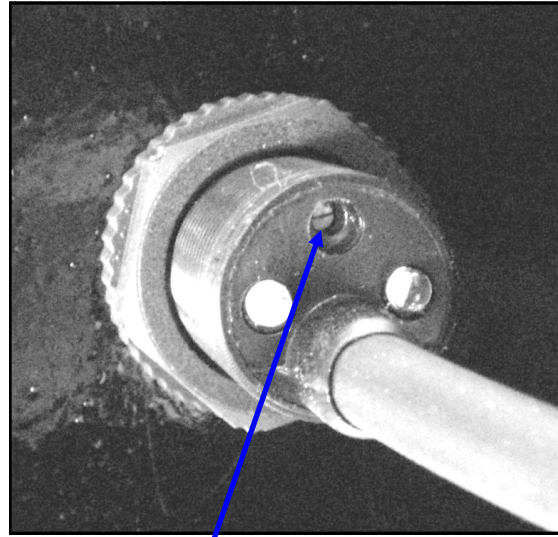

*Sensitivity Adjustment Screw*



*Proximity Switch Screwdriver*

Using the small screwdriver provided inside the control panel, you can adjust the proximity switch by turning the adjusting screw on the back of the proximity switch.

- Turn Clockwise to make the proximity switch more sensitive.
- Turn Counterclockwise to make the proximity switch less sensitive.

**SYSTEM ALARMS - FAULTS**

The table below and on the following pages provides a general description of all the system alarms (faults & warnings) of the MX Series Seed Treater. When a fault or warning condition is detected by the system, the alarms screen will pop-up describing the cause of the alarm or fault. Any motor fault will activate the alarm screen on the operator control panel. If running, the system will then progress to the controlled shutdown state. A warning will alert the operator of a system condition which needs attention or correction. The alarms are reset when the fault condition is cleared. The horn is silenced by pressing the “Silence Alarm” button on the alarm screen. For further assistance, contact your local USC dealer.

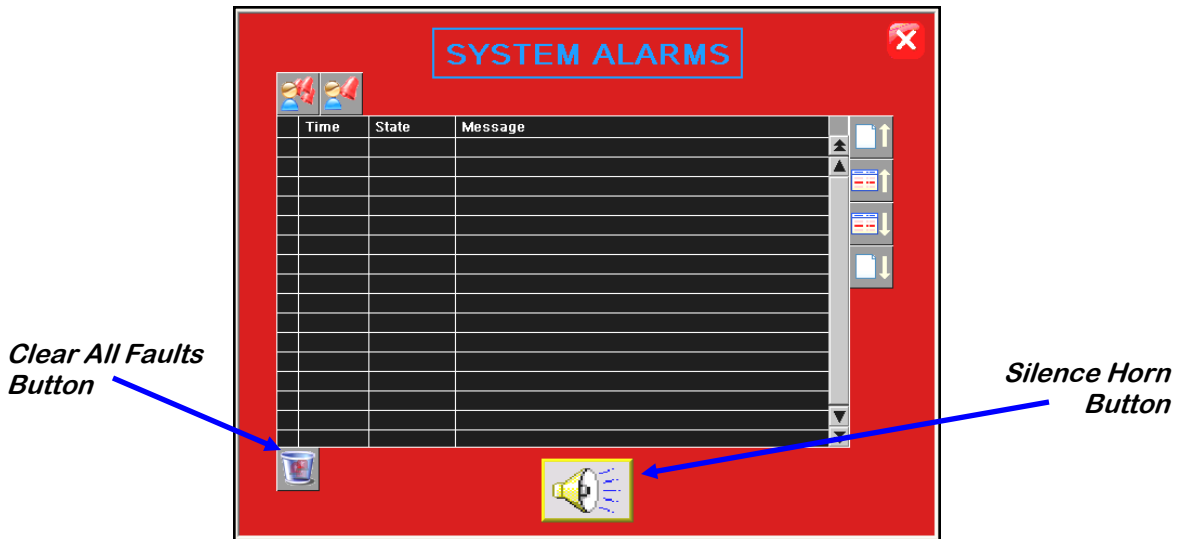

Alarm - Fault	Possible Cause	Solution
Drum Motor Fault	<ol style="list-style-type: none"> <li>1. Drum motor auxiliary contact was not sensed after being energized to run.</li> <li>2. Drum motor has been shutdown while in Auto mode of operation</li> </ol>	<ol style="list-style-type: none"> <li>1. Verify that the motor starter has power and is turned on.</li> <li>2. Verify that the Drum was not turned “Off” while the system was in Auto mode of operation.</li> </ol>
Seed Wheel Fault	<ol style="list-style-type: none"> <li>1. No signal from Seed Wheel motor drive (VFD) indicating that the Seed Wheel is running.</li> <li>2. Seed Wheel motor has been shutdown while in Auto mode of operation.</li> </ol>	<ol style="list-style-type: none"> <li>1. Verify that the VFD is powered up, or check if it is faulted out. Check the Information screen.</li> <li>2. Verify that the Seed Wheel was not turned “Off” while the system was in Auto mode of operation.</li> </ol>

Alarm - Fault	Possible Cause	Solution
Atomizer Motor Fault	<ol style="list-style-type: none"> <li>1. No signal from Atomizer motor drive (VFD) indicating that the Atomizer is running.</li> <li>2. Atomizer motor has been shutdown while in Auto mode of operation.</li> </ol>	<ol style="list-style-type: none"> <li>1. Verify that the VFD is powered up, or check if it is faulted out.</li> <li>2. Verify that the Atomizer was not turned "Off" while the system was in Auto mode of operation.</li> </ol>
Pump Motor Fault	<ol style="list-style-type: none"> <li>1. No signal from Pump motor drive (VFD) indicating that the Pump is running.</li> <li>2. Pump motor has been shutdown while in Auto mode of operation.</li> </ol>	<ol style="list-style-type: none"> <li>1. Verify that the VFD is powered up, or check if it is faulted out.</li> <li>2. Verify that the Pump was not turned "Off" while the system was in Auto mode of operation.</li> </ol>
Mix Tank Motor Fault	Mix Tank motor auxiliary contact was not sensed after being energized to run.	Verify that the motor starter has power and is turned on.
Inlet Conveyor Motor Fault	Inlet Conveyor motor auxiliary contact was not sensed after being energized to run.	Verify that the motor starter has power and is turned on.
Outlet Conveyor Motor Fault	Outlet Conveyor motor auxiliary contact was not sensed after being energized to run.	Verify that the motor starter has power and is turned on.
Pump - Not In Process:	Valve of the liquid displayed failed to divert to process when requested.	Verify valve has diverted, if so troubleshoot sensor, if not check air supply and signal to valve.
Seed Wheel - Lbs/Min Under Range	Actual Lbs/Min is under 95% of target rate.	Make sure the VFD is not maxed out at the specified target rate. Check for sluggish or oscillating Seed Wheel response. Call the manufacturer.

MX850

Alarm - Fault	Possible Cause	Solution
Check Operation Of Seed Sensors In Seed Wheel	Seed Wheel is in Auto mode of operation, and only one proximity sensor has been activated for the past ten seconds.	Verify both proximity sensors are working properly. (This alarm will also be activated if seed is only flowing through one side of the seed wheel.)
SURGE SUPPRESSOR - L1 FAILED!!!	L1 of the Surge Protector will no longer protect the electrical panel against voltage surges.	Replace the Surge Protector.

**PAUSED CONTROLLED WARNING**

The table below provides a general description of all the system warnings that could occur which would cause the system to pause. When a warning condition is detected, a window will pop-up notifying the operator that the system is “paused” because of a certain condition (below). When the condition has been corrected, the “CONTINUE” button can be pressed to restart the system. If the problem cannot be corrected, the “SHUTDOWN” button can be pressed.

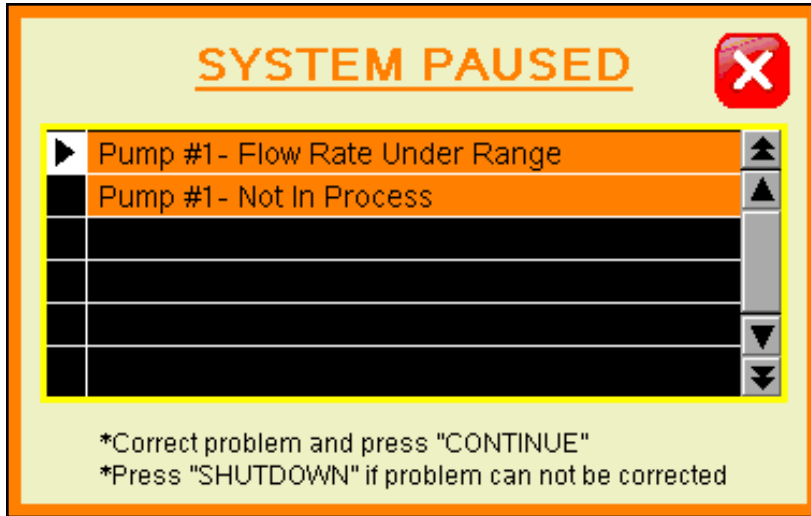

Warning	Possible Cause	Solution
Pump Flow Rate Under Range.	Actual flow rate is under 80% of target flow rate.	Check for empty supply tanks, worn or obstructed hoses, etc. that would cause a loss of liquid flow.
Pump #1 or #2 Not In Process	Valve of the liquid displayed failed to divert to process when requested	Verify valve has diverted, if so troubleshoot sensor, if not, check air supply and signal to valve.

**SYSTEM MESSAGES**

The table below provides a general description of all the system messages that could occur. When a warning condition is detected, a window will appear (below) notifying the operator that the system is will not start because of a certain condition. When the condition has been corrected, the “STARTUP” button can be pressed to start the system.

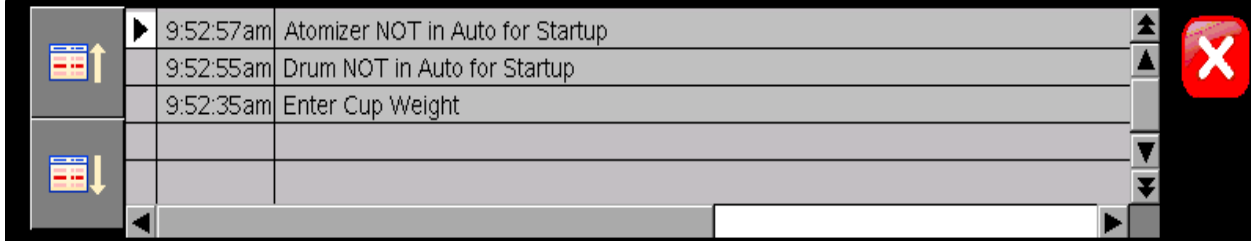

Message
Atomizer Not In Auto For Startup
Seed Wheel Not In Auto For Startup:
Drum Not In Auto For Startup
Enter Cup Weight
Current settings EXCEED maximum treater capacity. Check "target treating rate" and "cup weight" settings.
Current settings are below minimum treater capacity. Check "target treating rate" and "cup weight" settings.
Check pump flow rate - Must be above 80% Target Rate for 10 seconds.

**SECTION  
G****MAINTENANCE**

Proper maintenance of the MX Series Seed Treater is critical for peak performance, reliability and accuracy of this system. The following is a guideline for the type of maintenance and servicing that should be performed on this unit. Your environment and uses may require additional maintenance and service beyond this list to assure a reliable and safe unit. The operator of this unit has ultimate responsibility to identify areas of concern and rectify them before they become a hazard or safety issue. There is no substitute for a trained, alert operator.



Do not put this unit into operation with any questionably maintained parts. Poor performance or a hazard may occur.

**DRIVE AND DRUM**

- Inspect all welds and structural components on frame and drum for bends, cracks and damage.
- Remove shields and inspect pillow block bearings.
- Inspect drive wheels for unordinary wear, and setscrews for tightness.
- Inspect the Neoprene idler wheels.
- Tighten and lubricate chain.

**PUMPS AND PLUMBING**

- Check pump in forward and reverse.
- Make sure pump heads open and close smoothly.
- Inspect tubing and for uneven wear. Replace pump tubing often to ensure high flow rates can be met.
- Check air actuated 3-way valve. Clean brass filter if necessary
- Tighten hose clamps and check filter. Clean filter frequently to avoid blockages
- Flush flow meter with clean water frequently to avoid chemical buildup.

**SEED WHEEL**

- Inspect all welds and structural components for bends, cracks and damage.
- Remove shields to inspect wheel, brushes and proximity switches.
- Use compressed air to blow out any seeds and excess build-up that may have occurred during operation.
- Inspect RPM indicator. If loose, tighten bolt.



## ATOMIZER

To access inside of atomizer housing, push up on the quick release handle and slide back the atomizer (see picture below).



*Quick-Release Handle*

*Atomizer Head*

- Slide back atomizer housing and grease bearing inside. Bearing needs just one pump of grease every 40 hours of use.
- Clean any build-up inside the housing and the atomizer head. To remove the atomizer head, loosen the set screw located on the bottom of the head.
- Check for any play in the atomizer shaft.
- Make sure the atomizer spins smoothly.
- Ensure the adjustable chute is fitting completely into the drum opening. Adjust if necessary.



*Bearing*

*Set Screw*

**MIX TANK**

- Check motor.
  - Check for any play in the mix tank shaft.
  - Check valves, fittings, and plug on bottom of tank for leaks.
  - Check chemical line tubing for abnormal wear.
- 

**CONTROL PANEL**

- Check and tighten wire connections.
- Check quick connects on bottom of control panel.
- Check starters and overloads.
- Check relays and breakers.
- Check and set the proximity switches. (page 58)
- Check VFD's.

When storing the USC MX Series Seed Treater for long periods of time, the following procedure must be followed to reduce the chance of rust, corrosion and fatigue of the treater. You can also use these steps when storing the machine for the winter.



A dust mask and protective rubber gloves shall be used when cleaning the machine.

### **SUPPLY HOPPER & SEED WHEEL**

1. Turn power off to the treater.
2. Remove shields from the seed wheel and remove any debris or build-up. Compressed air can be used to blow out any foreign material.
3. Turn power back on to the treater and run seed wheel to help remove any additional debris. Compressed air can be used to blow out any foreign material.
4. Check brushes for wear (below).
5. Wipe off and clean the lens of the proximity switches (below).
6. Disconnect power and mount all guard back in place.
7. Tarp or cover the supply hopper and seed wheel to keep out any dirt or unwanted pests.

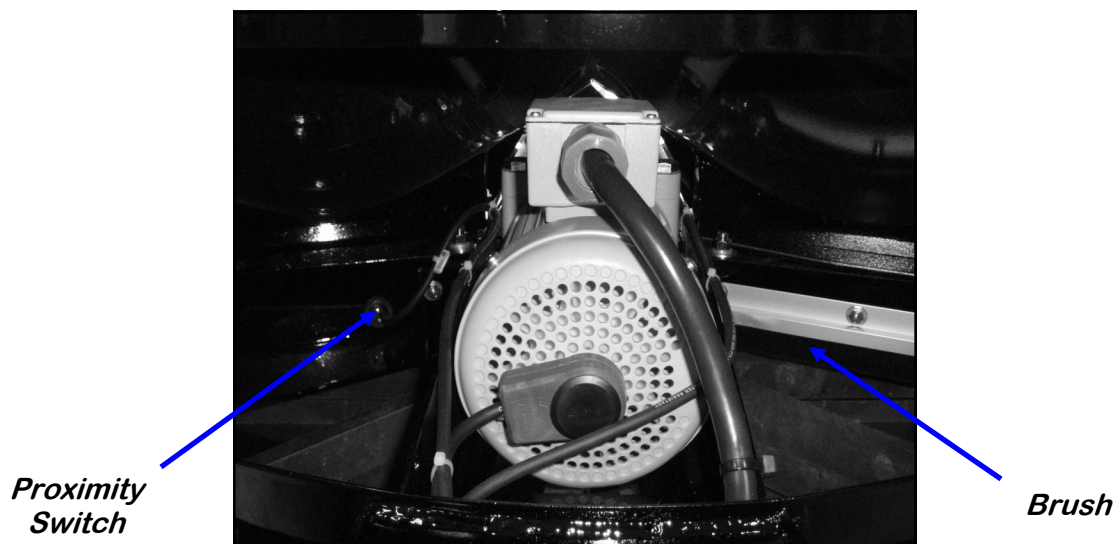

## **ATOMIZER CHAMBER**

1. Remove and clean the atomizer housing.
2. Remove the atomizer head and stainless steel plumbing. The atomizer head can be disassembled (right), for easier cleaning. It is threaded together and can simply be unscrewed.
3. Reinstall the atomizer head and plumbing. Grease the bearing and spin the atomizer head a few times to ensure all grease has been worked into the bearings.

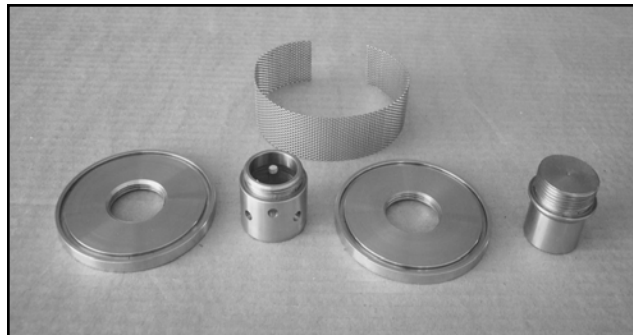

---

## **LIQUID SYSTEM**

1. Make certain the inside of the tank is completely drained of chemical residue and thoroughly flush the inside of the tank with clean water.
2. Remove and clean the filter.
3. Pump clean water through all areas of the plumbing including the mix tank, flow meter, and valves. It may be necessary to move the position of the air actuated 3-way valve from recirc to process in order to clean the chemical lines that run to the seed treater.
4. Open all drain points, valves, and filter to let as much of the liquid drain as possible.
5. If the seed treater will be exposed to possible freezing temperatures, the final flush of the system should be made with a non-freezable liquid. Or use compressed air to blow the lines out from any moisture.
6. Release pump heads (right) and remove tubing to prevent any unnecessary wear.



**ROTATING DRUM**

1. Remove the shields and clean out any seed that may have fallen underneath the drum.
  2. Clean out any residue left on the inside of the drum and around the seed lifters.
  3. Lubricate the chain to keep from corroding in storage.
- 

**FINAL**

1. Store the machine inside a protective building to keep it from being exposed to the weather.
2. Disconnect power to the machine.
3. Ensure all guards and safety signs are in place.

**MX850 Drum Drive & Guards**

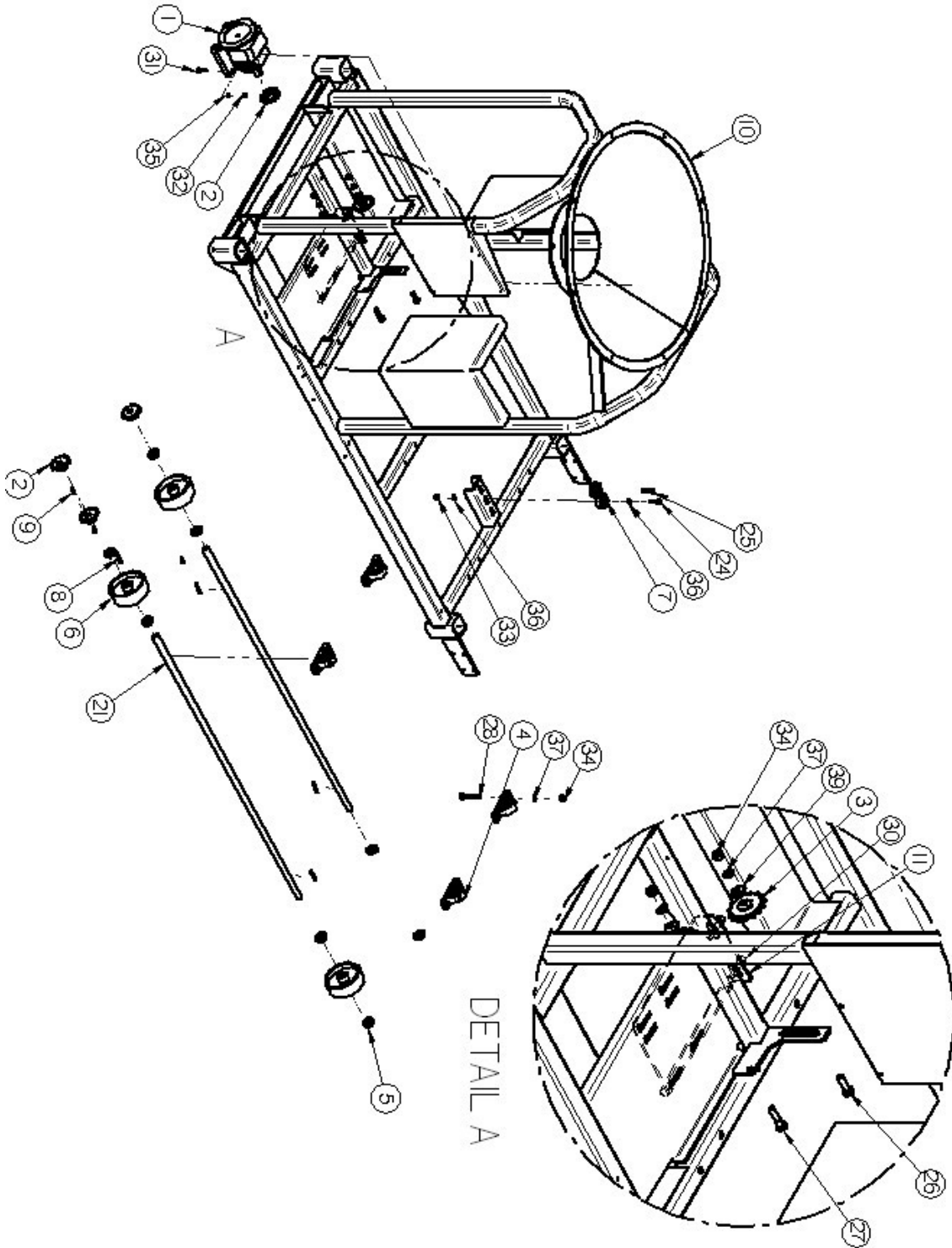

**MX850 Drum Drive & Guards**

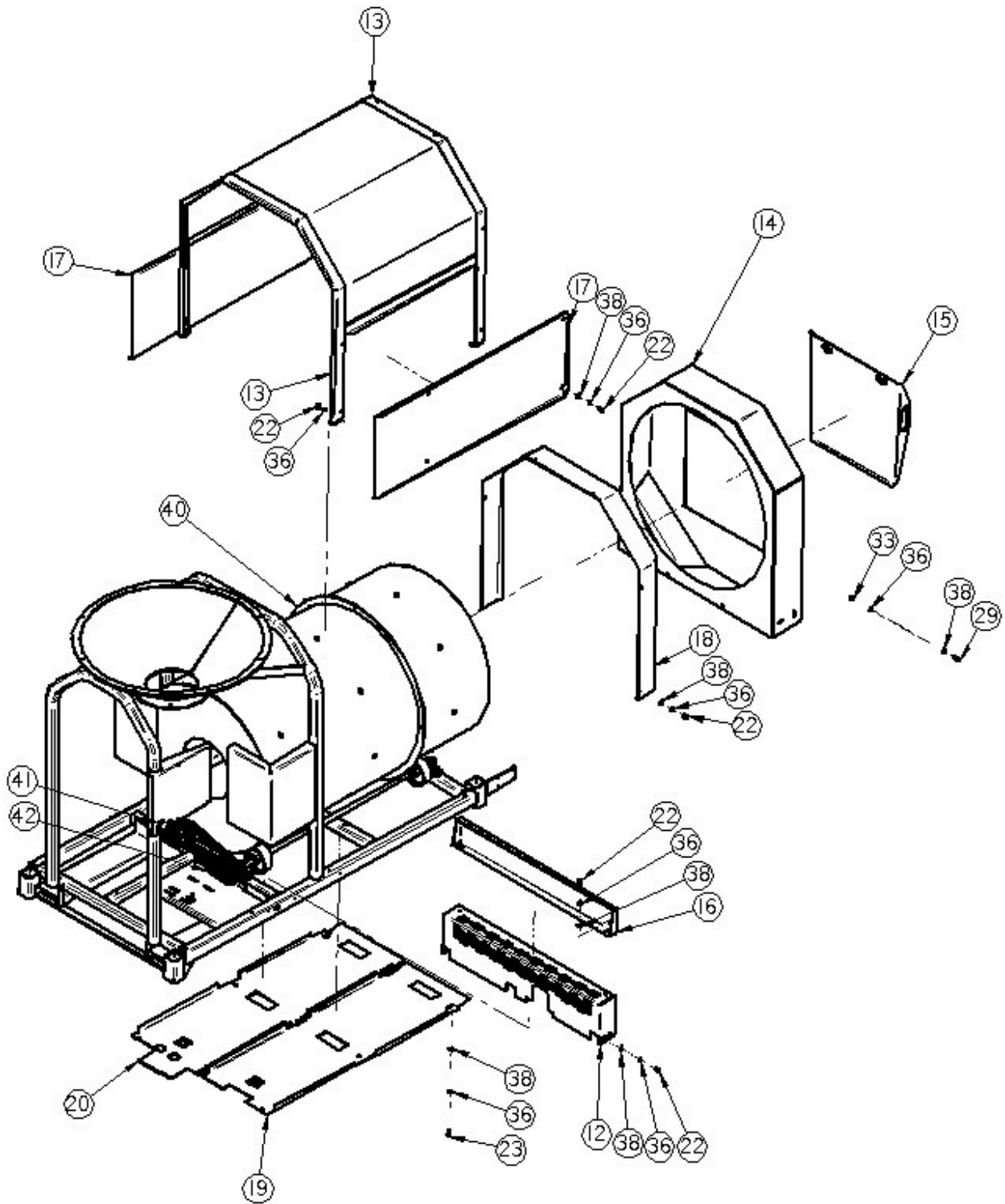

**MX850 Drum Drive & Guards Parts List**

<u>Item #</u>	<u>Part #</u>	<u>Title</u>	<u>Qty</u>
1	01-01-0101	GBOX IL 56C 16.2:1 GR B1 FOOT MNT	1
2	01-02-0093	SPROCKET, 50BS14H, 1" BORE	4
3	01-02-0095	SPKT 17 T 50P .500 ID IDLER	2
4	01-03-0036	BRG PLW 1.00ID STSC SEALED	4
5	01-05-0008	SHAFT CLR 1.00ID SPLIT	8
6	01-06-0002	WHL DRV 6 X 2 X 1.00ID .250KWY	4
7	01-06-0004	WHL GUIDE .375ID X 2.50 X .875 NPRN	2
8	01-10-0003	KEY .250 X 2.00 CS	4
9	01-10-0004	KEY .250 X 1.00 CS	4
10	05-03-0320	WDMT FRAME LX800/LX2000	1
11	05-04-0067	WDMT DRUM DRV ADJ PLT	1
12	05-06-0001	WDMT CHAIN GRD LP800/LP2000	1
13	05-06-0013	WDMT DRUM GRD LP800/LP2000	1
14	05-07-0017	WDMT END CHUTE LP800	1
15	05-07-0198	ASSY END CHUTE DOOR GALV	1
16	05-10-0150	GRD DRUM INLET LOWER	1
17	05-10-0875	GRD DRUM SIDE LP800/LP2000	2
18	05-10-0876	GRD DRUM EXT LP800	1
19	05-10-2366	GRD DRUM BTM RIGHT	1
20	05-10-2367	GRD DRUM BTM LEFT	1
21	05-11-0002	DRUM DRV SHAFT LP800	2
22	06-01-0015	BOLT .375-16 X 1.00 ZP GR5	24
23	06-01-0016	BOLT .375-16 X 1.00 ZP GR5	9
24	06-01-0018	BOLT .375-16 X 1.50 ZP GR5	1
25	06-01-0019	BOLT .375-16 X 1.75 ZP GR5	1
26	06-01-0026	BOLT CRG .500-13 X 2.00 ZP GR5	1
27	06-01-0027	BOLT .500-13 X 2.00 ZP GR5	1
28	06-01-0029	BOLT .500-13 X 3.25 ZP GR5	8
29	06-01-0053	BOLT .375-16 X 1.25 ZP GR5	4
30	06-01-0137	BOLT .375-16 X 2.00 ZP GR5 FULL THRD	2



**MX850 Drum Drive & Guards Parts List**

<u>Item #</u>	<u>Part #</u>	<u>Title</u>	<u>Qty</u>
31	06-01-0172	BOLT CRG .313-18 X 1.75 ZP GR5	4
32	06-02-0002	NUT FULL .313-18 ZP GR5	4
33	06-02-0003	NUT FULL .375-16 ZP GR5	7
34	06-02-0004	NUT FULL .500-13 ZP GR5	10
35	06-04-0002	WSHR LOCK SPLT .313 ZP	4
36	06-04-0003	WSHR LOCK SPLT .375 ZP	39
37	06-04-0004	WSHR LOCK SPLT .500 ZP	10
38	06-05-0004	WSHR FLAT .375 ZP	34
39	06-05-0005	WSHR FLAT .500 ZP	2
40	13-04-0083	KIT DRUM FOR LXP 2500	1
41	13-05-0156	#50 CHAIN 84LINKS	1
42	13-05-0157	#50 CHAIN -- 32 LINKS	1

**MX850 Atomizer Quick Release Gate**

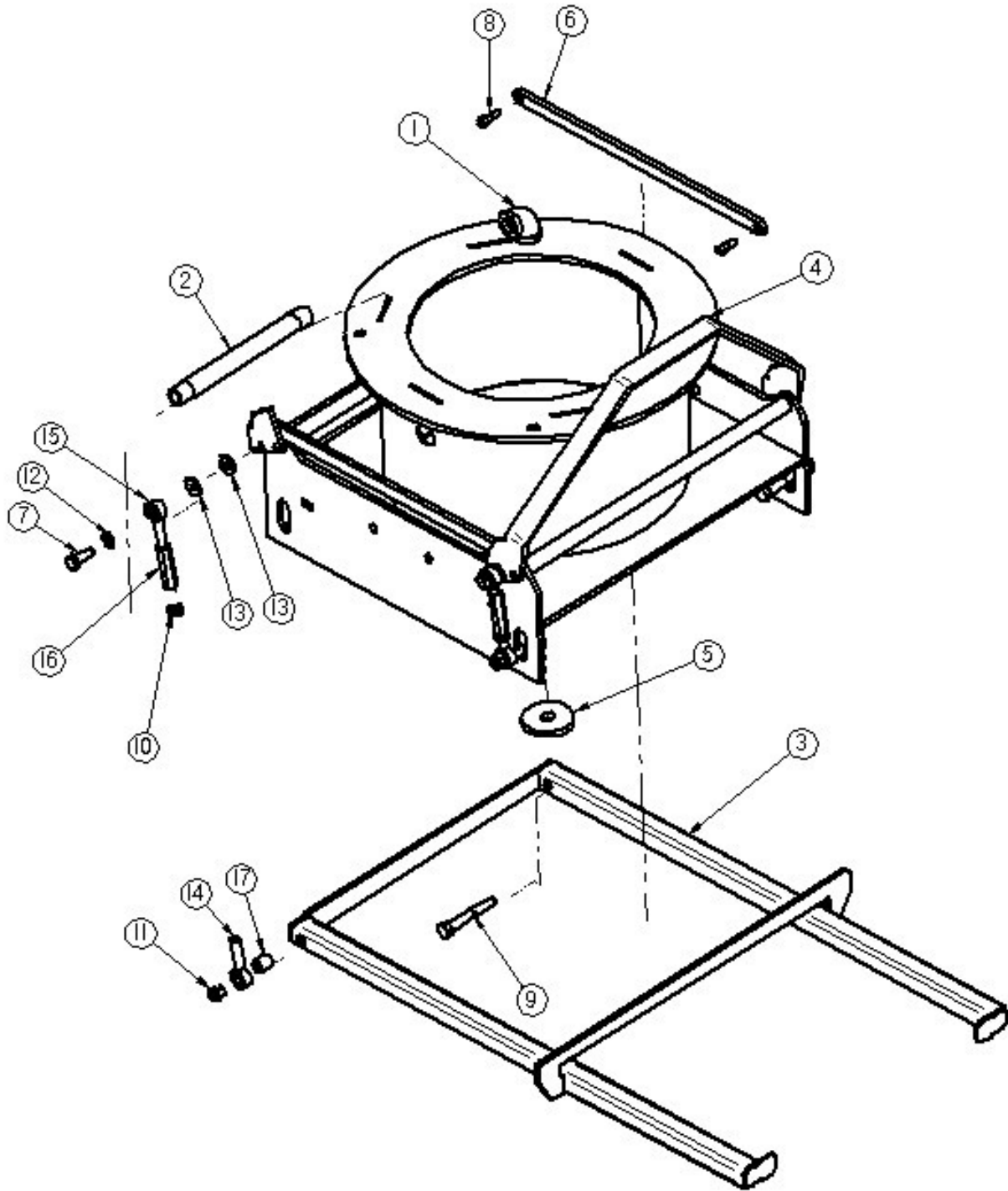

**MX850 Atomizer Quick Release Gate Parts List**

<b>Item #</b>	<b>Part #</b>	<b>Title</b>	<b>Qty</b>
1	02-06-0012	ELBOW, .500-14 NPT, 90 DEG. SS	1
2	02-07-0034	NIPPLE .500 NPT 8" LG TBE SS	1
3	05-03-0341	WDMT MAIN CHMBR SUPP BRKT LX800 CS	1
4	05-03-0549	WDMT MAIN CHMBR MX850 SS	1
5	05-10-0360	DISC STD ATMZR HEAD CVR	1
6	05-10-2118	GUIDE SUPP BRKT LX800 CS	2
7	06-01-0016	BOLT .375-16 X 1.00 ZP GR5	4
8	06-01-0081	BOLT SHLD .313SHX.250-20X.375 GR5	4
9	06-01-0116	BOLT .375-16 X 2.75 ZP GR5	4
10	06-02-0035	NUT, .375-24 UNF ZP GRADE 5	4
11	06-03-0003	NUT NYL LOCK .375-16 ZP GR5	4
12	06-04-0003	WSHR LOCK SPLT .375 ZP	4
13	06-05-0003	WSHR FLAT .313 ZP	8
14	06-12-0002	REND .375-24 BALL LH	4
15	06-12-0003	REND .375-24 BALL RH	4
16	06-12-0006	NUT, .375-24 x 2, ALUM RH_LH CONNECT	4
17	06-12-0007	BUSH DRILL.375ID X .625OD X .625	4

MX850

**MX850 Atomizer**

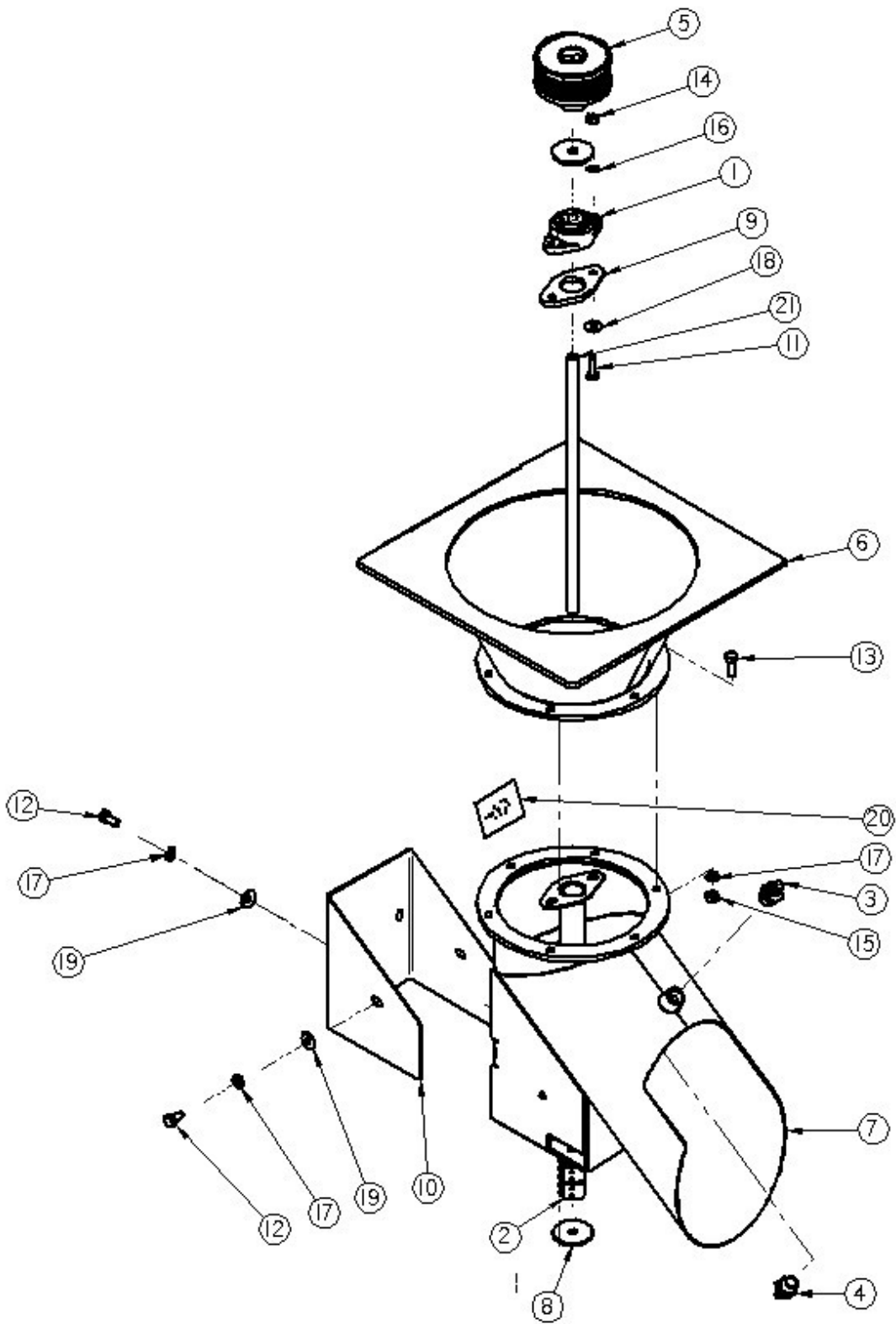

**MX850 Atomizer Parts List**

<b><u>Item #</u></b>	<b><u>Part #</u></b>	<b><u>Title</u></b>	<b><u>Qty</u></b>
1	01-03-0002	BRG FLG MNT .625ID 3.875 BASE	1
2	01-07-0027	CPLG CLPN .625 X .625 SPLT CS	1
3	02-06-0010	FTTG 90 DEG .500HB X .500NPT ML NYL	1
4	02-08-0005	1/2-14 NPT, 3/8 BARB, STRAIGHT WP	1
5	04-02-0004	ASSY,ATOMIZER HEAD,4" COTTON	1
6	05-03-0550	WDMT ATMZR CHMBR MX850 SS	1
7	05-07-0218	WDMT OUTLET CHUTE MX850 SS	1
8	05-10-0805	DISK ATOMIZER MOTOR	2
9	05-10-2462	SEAL RBBR .625 FLG BRG	1
10	05-10-3122	PLT COVER LX800 ATMZR	1
11	06-01-0012	BOLT .313-18 X 1.00 ZP GR5	2
12	06-01-0015	BOLT .375-16 X 1.00 ZP GR5	4
13	06-01-0016	BOLT .375-16 X 1.00 ZP GR5	6
14	06-02-0002	NUT FULL .313-18 ZP GR5	2
15	06-02-0003	NUT FULL .375-16 ZP GR5	6
16	06-04-0002	WSHR LOCK SPLT .313 ZP	2
17	06-04-0003	WSHR LOCK SPLT .375 ZP	10
18	06-05-0003	WSHR FLAT .313 ZP	2
19	06-05-0004	WSHR FLAT .375 ZP	4
20	09-02-0004	ATWK LBL GRS 40HRS	1
21	11-07-0077	DRIVE SHAFT,ATOMIZER MOTOR	1

MX850

**MX850 Seed Wheel**

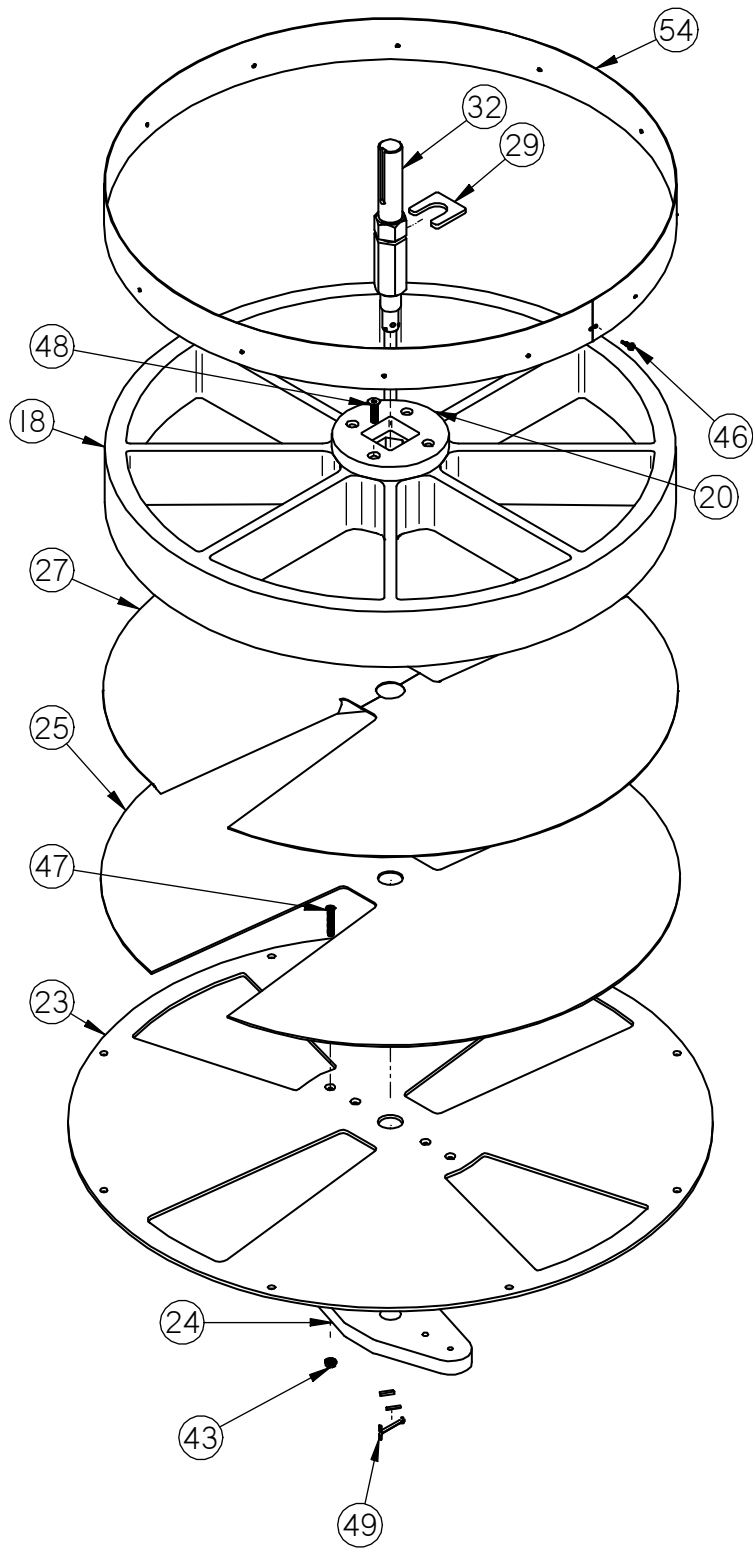



**MX850 Seed Wheel**

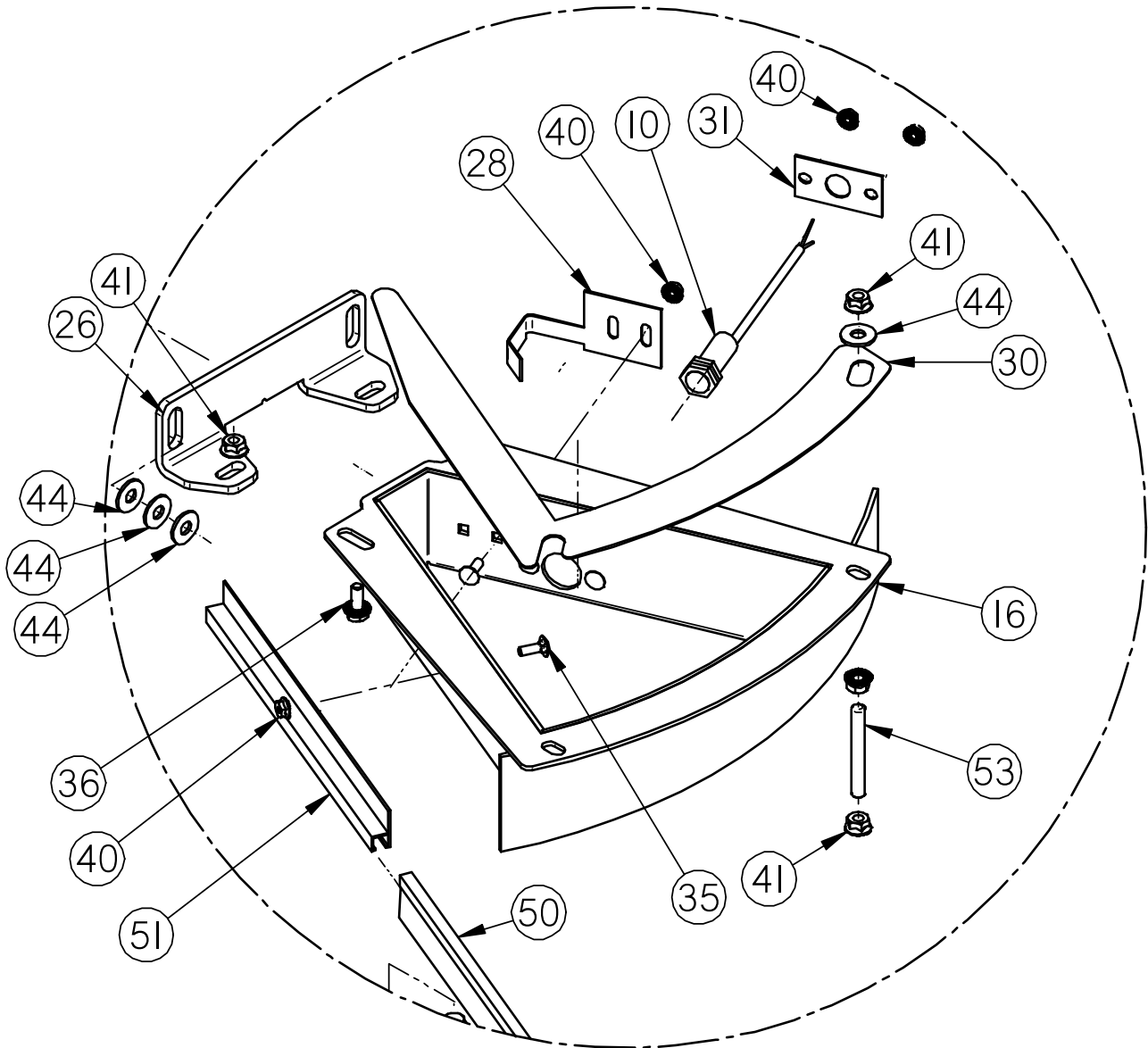

DETAIL A



**MX850 Seed Wheel**

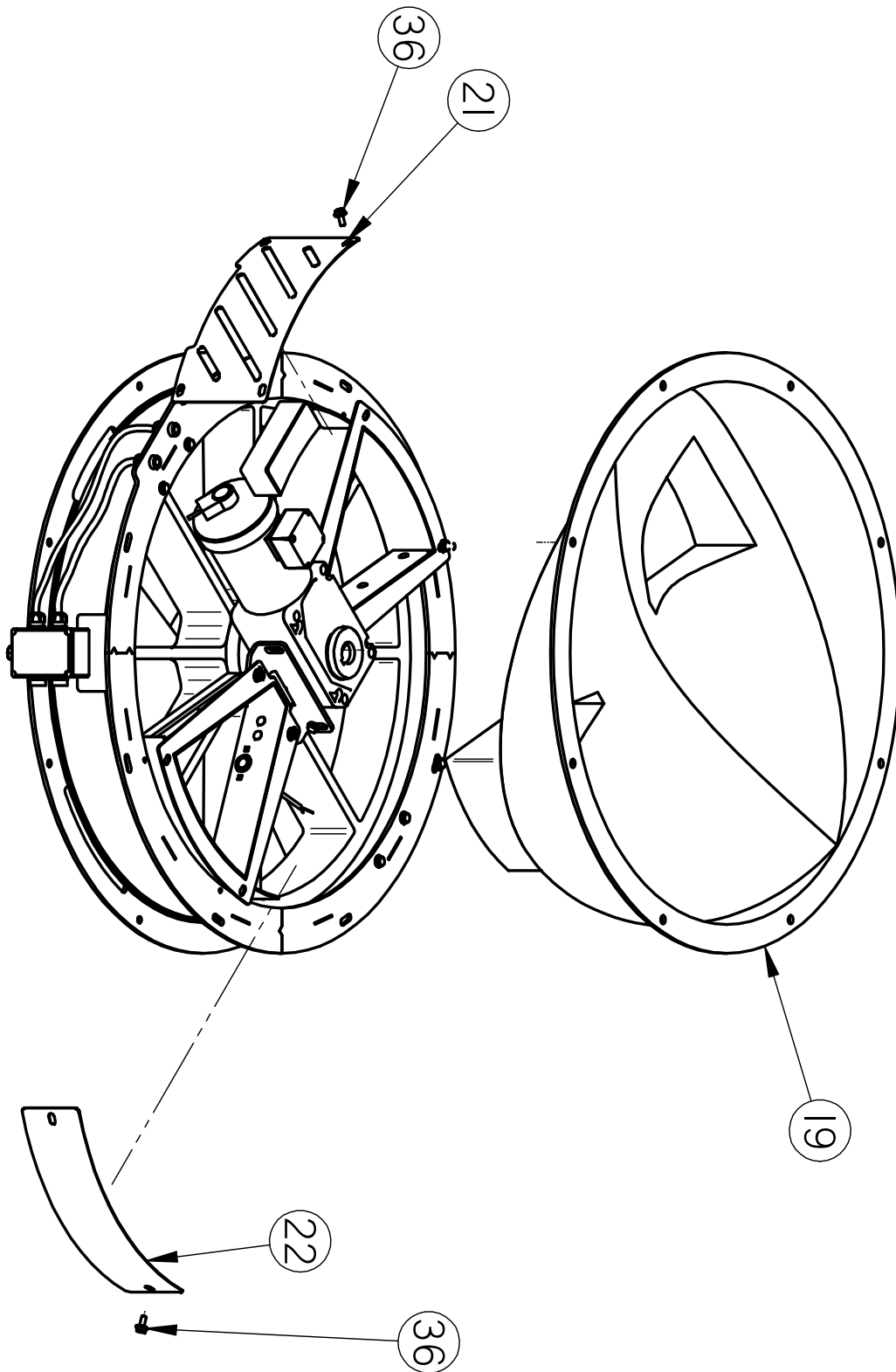

**MX850 Seed Wheel**

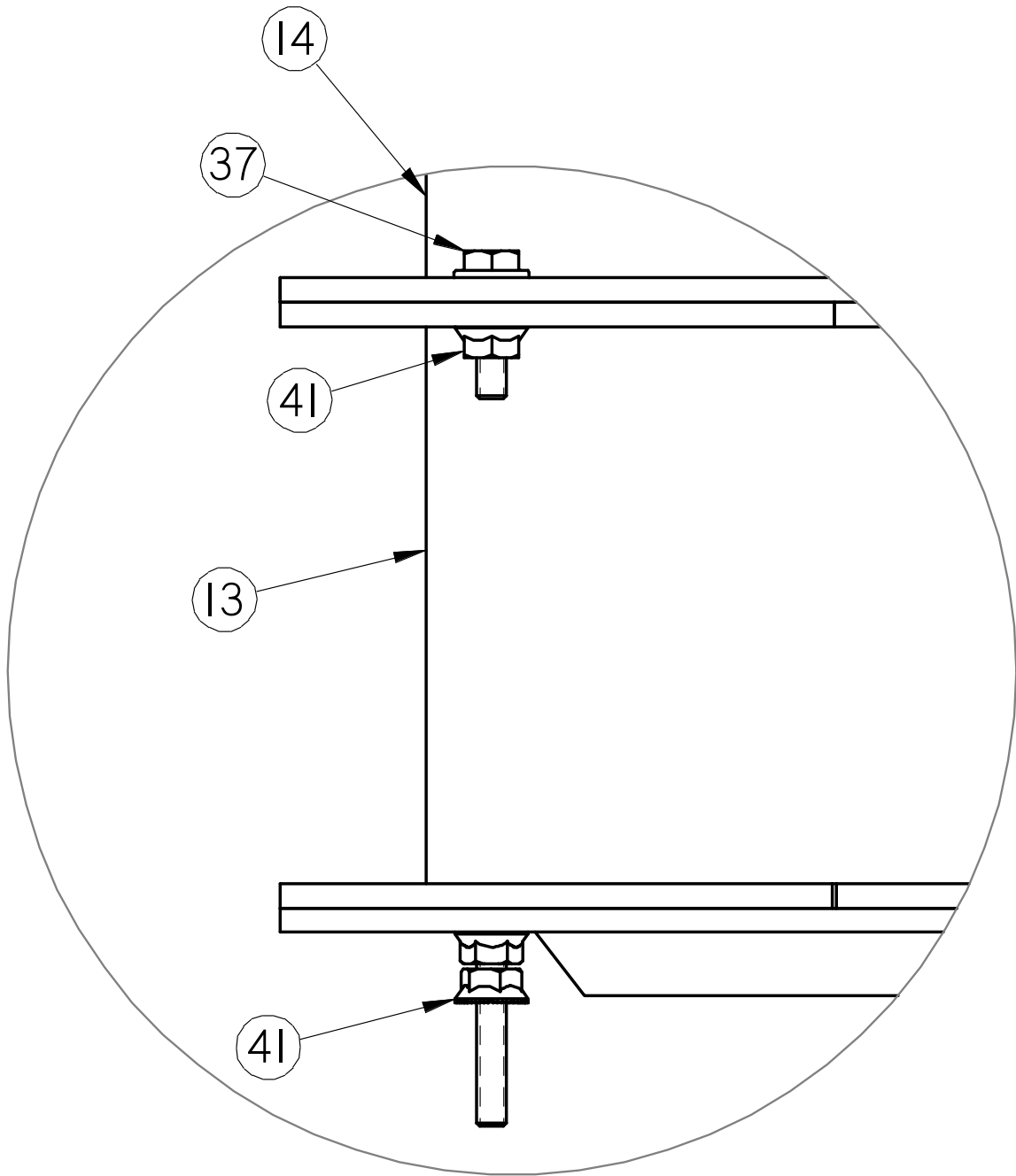

DETAIL C

**MX850 Seed Wheel Parts List**

<u>Item Number</u>	<u>USC Part Number</u>	<u>Description</u>	<u>Quantity</u>
3	01-01-0096	GMTR RA .50 HP 11RPM 3PH HLLW SHAFT	1
4	03-05-0042	TMNL BARRIER STRIP IDEAL 89-608	1
5	03-06-0039	RECP 4PL ML PIN HBMS04501	1
6	03-06-0059	RECP 8PL ML PIN HBMS08501	1
7	03-07-0063	CORD 4COND 16AWG SHLD V16016 ALPHA	1
8	03-08-0134	LPCG503 ARLINGTON 1/2NPT RANGE:.100/.300	1
9	03-08-0138	CONN CG PLAS 0.5NPT .375-.750	5
10	03-10-0051	SENS PROX 24-240 AC AB 875CPG8N18A2	2
11	03-10-0086	RTRY PULSE GEN PU-40E WITH CBL	1
12	03-11-0081	ENCL 4.5X3X2 POLY HOF Q1286PCD	1
13	05-03-0164	WDMT SEED METER BODY EXTEN	1
14	05-03-0169	WDMT SEED METER EXTENSION	1
15*	05-03-0232	WDMT SMW UPPER BRG BRKT	1
16	05-03-0240	WDMT SMW BRSH PCKT	2
17*	05-04-0049	WDMT SEED WHEEL SHAFT NUT	1
18	05-07-0196	MOLDED SEED WHEEL INSERT	1
19	05-07-0197	HPPR SMW DUAL DSCHG ROTO-MLDD	1
20	05-07-0203	MOLDED SEED WHEEL INSERT TOP	1
21	05-10-0890	CVR #1 SEED METER	2
22	05-10-0891	CVR #2 SEED METER	2
23	05-10-0893	PLATE SUPPORT SEED METER STEEL	1
24	05-10-1213	SUPP BTM BRG UHMW SEED METER	1
25	05-10-1306	PAD SEED WHL FOAM RBBR FLOATING	1
26	05-10-1392	BRKT SMW BRSH PCKT HLDR	2
27	05-10-1426	14GA WEAR SPLATE HALF	2
28	05-10-1449	PLT SMW CTR HUB WIPER	2
29	05-10-1588	PLT SHAFT CLIP SMW	1
30	5/10/2166	CVR TEST	2

**MX850 Seed Wheel Parts List**

<u>Item Number</u>	<u>USC Part Number</u>	<u>Description</u>	<u>Quantity</u>
31	5/10/3316	SMW PROX SW HOLDER	2
32	05-11-0075	DRIVE SHAFT 1.4375 SHAFT	1
33	06-01-0091	SRCW, PAN HD, 10-32 X 1.25 ZP	1
34	06-01-0106	BOLT .500-13 X 5.50 ZP GR5	1
35	06-01-0122	BOLT, CARRIAGE, .250-20x.75 G5 ZP	18
36	06-01-0124	BOLT, FLG .375-16 UNC ZP GRADE 5; 3/4" LG	18
37	06-01-0189	BOLT, FLG .375-16 UNC ZP GRADE 5; 1-1/4" LG	1
38	06-01-0204	BOLT, FLG .375-16 UNC ZP GRADE 5; 2-1/2" LG	1
39	06-02-0034	NUT 8-32 K-LOCK ZP	1
40	06-03-0013	NUT,LOCK, FLG .250-20 ZP SERRATED	22
41	06-03-0014	NUT LOCK FLG .375-16 ZP GR5	16
42	06-03-0015	NUT LOCK FLG .500-13 ZP GR5	1
43	06-03-0019	NUT LOCK FLG .3125-18 ZP GR5	1
44	06-05-0004	WSHR FLAT .375 ZP	10
45	06-06-0004	SCRW MACH 8-32 X .500 PHLP RDHD ZP	1
46	06-06-0023	SCRW, SELF TAPPING, 10-16 ZP X .750	2
47	06-06-0046	SCRW .313-18 X 2.0 ZP FLAT HD PHLP	1
48	06-06-0070	SCRW MACH .375-16 X 1.50 SH FLHD BO	1
49	06-09-0023	PIN CTTR .188 X 2.00 ZP	1
50	06-10-0019	SEAL BRSH 12.75 OAL 1IN EXP LG	2
51	06-10-0020	12 IN LG BRUSH HOLDER	2
52	06-12-0021	SPCR .192ID X .3125OD X .500 LG ZP	1
53	06-14-0013	.375-16 THD RD CS	3
54	101BC9	PSM SMW GALV RING	1
55	11-13-0004	KEYSTOCK 3/8 X 3/8 CS	1



**MX850 Seed Treater Parts List**

<u>Item #</u>	<u>Part #</u>	<u>Title</u>	<u>Qty</u>
1	03-10-0051	SENS PROX 24-240 AC AB 875CPG8N18A2	1
2	03-12-0064	PNL CNTL PLC ST LX800/2000 JBOX	1
3	03-20-0003	KIT PWR 230V 1PH LX800/2000	1
4	04-01-0034	ASSY ADJ CHMBR LX800 CS	1
5	04-01-0035	ASSY ATMZR TRTR MX850 SS	1
6	04-03-0097	STATIC MXR & VALVE ASSY	1
7	05-05-0001	WDMT ADJ TREATER LEG	4
8	05-07-0008	WDMT INLET HOPP EXT	1
9	05-07-0119	LP800 SEED WHEEL FLOW BALANCER	1
10	05-10-0362	PLT HOPP EXT VIEW	3
11	06-01-0004	BOLT .250-20 X .500 ZP GR5	4
12	06-01-0006	BOLT .250-20 X .750 ZP GR5	9
13	06-01-0016	BOLT .375-16 X 1.00 ZP GR5	8
14	06-01-0024	BOLT .500-13 X .750 ZP GR5	4
15	06-01-0053	BOLT .375-16 X 1.25 ZP GR5	4
16	06-02-0001	NUT FULL .250-20 ZP GR5	9
17	06-02-0003	NUT FULL .375-16 ZP GR5	12
18	06-03-0013	NUT,LOCK, FLG .250-20 ZP SERRATTED	4
19	06-04-0001	WSHR LOCK SPLT .250 ZP	9
20	06-04-0003	WSHR LOCK SPLT .375 ZP	12
21	06-05-0001	WASHER, FLAT .250	9
22	06-05-0004	WSHR FLAT .375 ZP	4
23	06-09-0002	PIN CLIP HITCH 3.063 SIZE 9 ZP	4
24	06-09-0005	PIN CLVS .500 X 3.50 PLN	4
25	13-04-0065	ASSY SEED METER LX2000	1
26	13-11-0023	ASSY BASE LX800 TRTR	1

**MX850 Pump Stand**

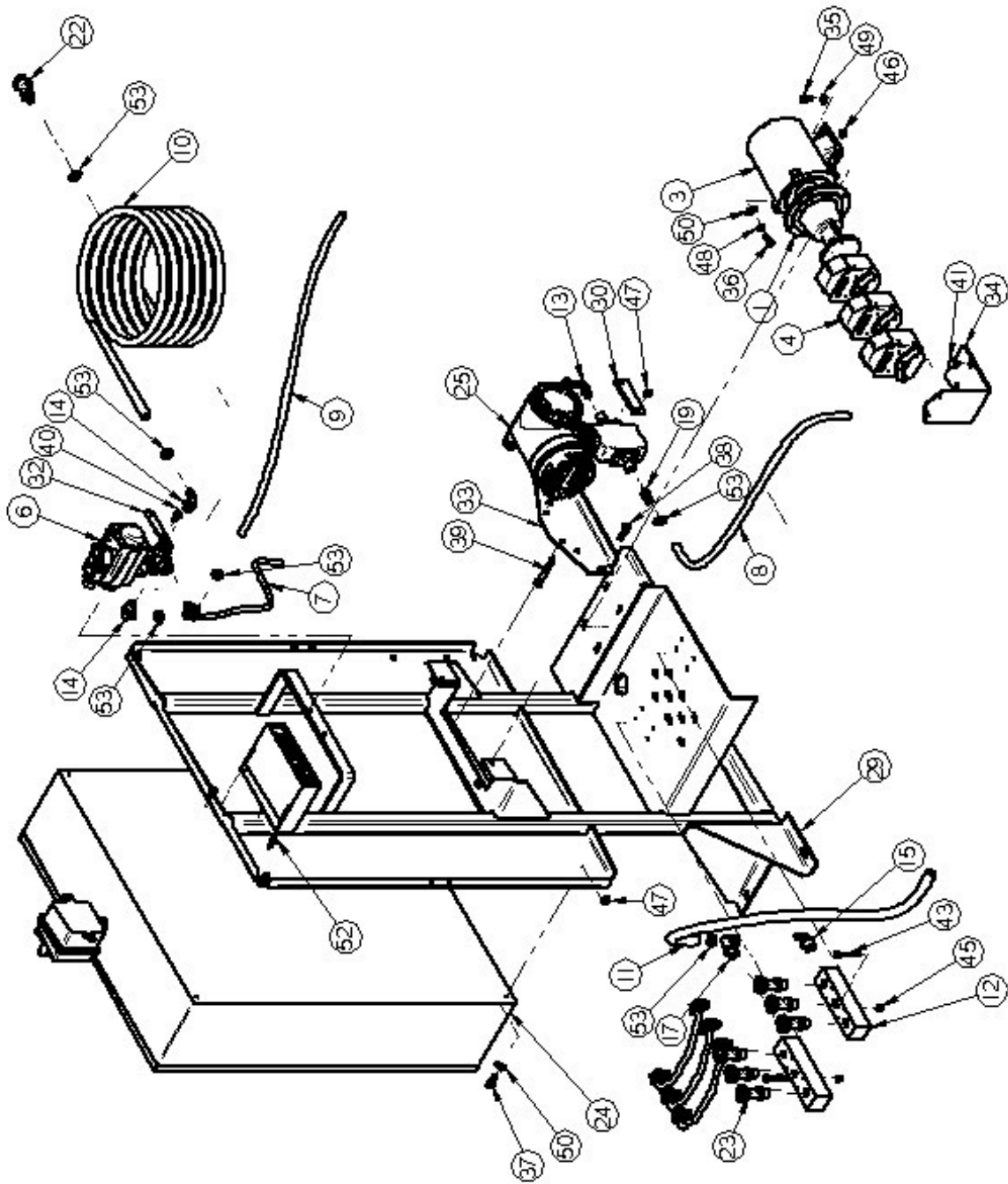

MX850

**MX850 Pump Stand**

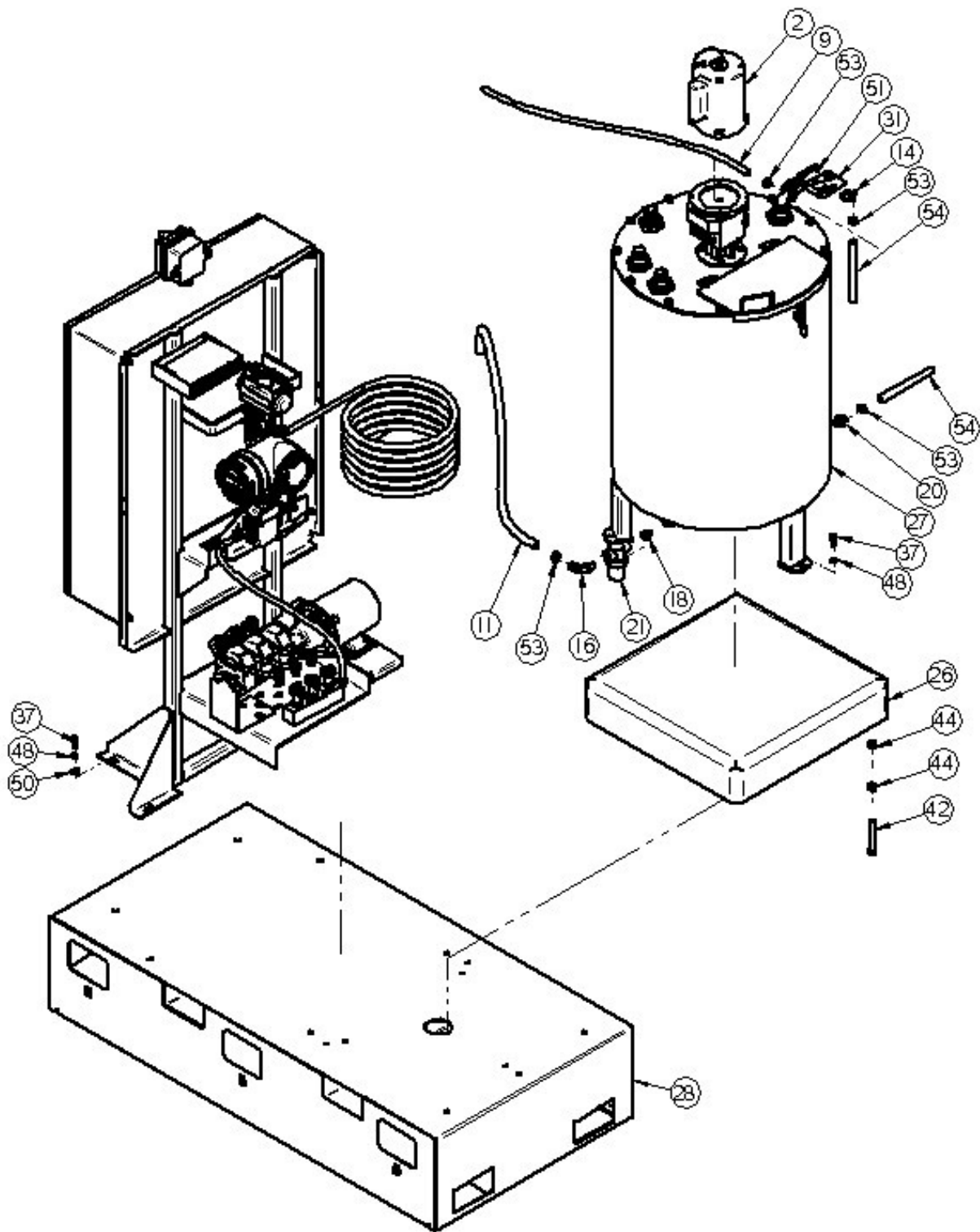



**MX850 Pump Stand Parts List**

<u>Item #</u>	<u>Part #</u>	<u>Title</u>	<u>Qty</u>
1	01-01-0066	SPEED REDUCER, 3.7 TO 1	1
2	01-01-0080	MTR .33HP 1725RPM 56C 1PH TEFC	1
3	01-01-0111	MTR .33 HP 1725 RPM S56C 3PH TENV*	1
4	02-01-0005	PUMP HEAD PRST MF LS 115V 600RPM	3
5	02-01-0033	PUMP 3 MF HARDWARE SS - LS HEAD	1
6	02-02-0035	VALVE .500NPT 3WAY AIR ACTUATED	1
7	02-03-0005	.5 RNT Tubing 19" LG	1
8	02-03-0005	.5 RNT Tubing 25" LG	1
9	02-03-0005	.5 RNT Tubing 33" LG	1
10	02-03-0005	APPLICATION TUBE 180" LONG	1
11	02-03-0006	.75 RNT Tubing 36" LG	1
12	02-05-0043	FTTG MANIFOLD UHMW 1 IN 3 OUT	2
13	02-06-0009	3/8-18 NPT, 1/2 BARB, 90 DEG. WP	1
14	02-06-0010	FTTG 90 DEG .500HB X .500NPT ML NYL	4
15	02-06-0011	FTTG 90 DEG .750HB X .500NPT ML NYL	1
16	02-06-0013	1/2-14 NPT, 3/4 BARB, 90 DEG. BP	1
17	02-06-0015	BARB, .750-14 NPT X .750 90DEG WP	1
18	02-07-0054	.500 Closed Nipple 4882K13	1
19	02-08-0006	FTTG STGHT .500HB X .375NPT ML NYL	1
20	02-08-0007	FTTG STGHT .500HB X .500NPT ML NYL	2
21	02-12-0002	FLTR TEE PPE .500 NPT 40 MESH LRG	1
22	02-15-0013	FTTG CPLG .500 HB QCK DISC BODY	1
23	02-15-0016	FTTG CPLG .500 NPT QCK DISC BODY	6
24	03-12-0085	PNL CNTL PLC ST LX800/2000 STD	1
25	03-18-0008	ASSY FLMT PROMAG 53H DN W/MODBUS	1
26	03-19-0028	SCL, 24' X 24" 1000 LB BASE	1
27	04-03-0099	50 GAL CHEM TNK 3 INLET	1
28	05-03-0338	WDMT,27&50GAL SC MNT BASE	1
29	05-03-0485	WDMT MX PUMP PNL FRM	1
30	05-10-2038	BRKT FLMT MNT PROMAG 53H	1

**MX850 Pump Stand Parts List**

<u>Item #</u>	<u>Part #</u>	<u>Title</u>	<u>Qty</u>
31	05-10-2080	LBL TRTR MIX TANK	1
32	05-10-2608	PLT AIR VLV CLMP	1
33	05-10-2682	BRKT FLMT MNT PROMAG 53H LX PUMP	1
34	05-10-2908	LS MF PUMP HEAD SUPT	1
35	06-01-0010	BOLT .313-18 X .750 ZP GR5	4
36	06-01-0012	BOLT .313-18 X 1.00 ZP GR5	4
37	06-01-0016	BOLT .375-16 X 1.00 ZP GR5	15
38	06-01-0053	BOLT .375-16 X 1.25 ZP GR5	2
39	06-01-0116	BOLT .375-16 X 2.75 ZP GR5	2
40	06-01-0138	BOLT, FLG .315-18 UNC ZP GRADE 5; 3/4" LG	2
41	06-01-0153	BOLT CRG .375-16X.750 ZP SHORT NECK	3
42	06-01-0157	BOLT, .500-13 X 4" UNC ZP GRADE 5 fth	4
43	06-01-0192	BOLT .250-20 X 2.50 ZP GR5	8
44	06-02-0004	NUT FULL .500-13 ZP GR5	8
45	06-03-0001	NUT,LOCK, .250-20 ZP G5 NYLON INSERT	8
46	06-03-0002	NUT NYL LOCK .313-18 ZP GR5	4
47	06-03-0003	NUT NYL LOCK .375-16 ZP GR5	11
48	06-04-0003	WSHR LOCK SPLT .375 ZP	15
49	06-05-0003	WSHR FLAT .313 ZP	4
50	06-05-0004	WSHR FLAT .375 ZP	12
51	06-06-0029	SCRW MACH 10-24 X .375 PHLP PHD ZP	2
52	06-06-0037	SCRW SDST .250-14 X 1.000 HH ZP	2
53	06-07-0006	CLMP HOSE .500 TO .906 X .313W ZP	13
54	13-05-0024	HOSE .500 RNT 12IN	2
55	13-05-0135	HOSE MX2500 MF TYPE	3

# LIMITED WARRANTY

## SECTION J

USC, LLC, (Manufacturer) warrants its seed treating equipment as follows:

1. **Limited Warranty:** Manufacturer warrants that the Products sold hereunder will be free from defects in material and workmanship for a period of 12 months from date of shipment. If the Products do not conform to this Limited Warranty during the warranty period, Buyer shall notify Manufacturer in writing of the claimed defects and demonstrate to Manufacturer satisfaction that said defects are covered by this Limited Warranty. If the defects are properly reported to Manufacturer within the warranty period, and the defects are of such type and nature as to be covered by this warranty, Manufacturer shall, at its expense, furnish replacement Products or, at Manufacturer's option, replacement parts for the defective products. Shipping and installation of the replacement Products or replacement parts shall be at the Buyer's expense.

2. **Other Limits:** THE FOREGOING IS IN LIEU OF ALL OTHER WARRANTIES, EXPRESSED OR IMPLIED, INCLUDING BUT NOT LIMITED TO THE IMPLIED WARRANTIES OF MERCHANTABILITY AND FITNESS FOR A PARTICULAR PURPOSE. Manufacturer does not warrant against damages or defects arising from improper installation (where installation is by persons other than Manufacturer), against defects in products or components not manufactured by Manufacturer, or against damages resulting from such non-Manufacturer made products or components. Manufacturer passes on to the Buyer the warranty it received (if any) from the maker of such non-Manufacturer made products or components. This warranty also does not apply to Products upon which repairs and/or modifications have been effected or attempted by persons other than pursuant to written authorization by Manufacturer. Manufacturer does not warrant against casualties or damages resulting from misuse and/or abuse of product(s), acts of nature, effects of weather, including effects of weather due to outside storage, accidents, or damages incurred during transportation by common carrier.

3. **Exclusive Obligation:** THIS WARRANTY IS EXCLUSIVE. The sole and exclusive obligation of Manufacturer shall be to repair or replace the defective Products in the manner and for the period provided above. Manufacturer shall not have any other obligation with respect to the Products or any part thereof, whether based on contract, tort, strict liability or otherwise. Under no circumstances, whether based on this Limited Warranty or otherwise, shall Manufacturer be liable for incidental, special, or consequential damages.

4. **Other Statements:** Manufacturer's employees or representatives' oral or other written statements do not constitute warranties, shall not be relied upon by Buyer, and are not a part of the contract for sale or this limited warranty.

5. **Return Policy:** Approval is required prior to returning goods to USC, LLC. A restocking fee will apply.

6. **Entire Obligation:** This Limited Warranty states the entire obligation of Manufacturer with respect to the Products. If any part of this Limited Warranty is determined to be void or illegal, the remainder shall remain in full force and effect.



**USC, LLC**

2320 124th road

Sabetha, Ks 66534

PHONE: (785) 431-7900

FAX: (785) 431-7950

EMAIL: [sales-team@uscllc.com](mailto:sales-team@uscllc.com)

WEB: [www.uscllc.com](http://www.uscllc.com)